



xavax[®]

The powerful
Household brand

-  Lighting
-  Coffee & Tea
-  Household goods & Decoration
-  Small household appliances
-  Cleaning & Care
-  Energy & Technology
-  Accessories for household appliances

Complete Catalogue 2016



The powerful
Household brand



The Brand

Xavax – The powerful Household brand		4
Sales aids		6
Xavax – always present		7
Web portals		7

Lightning

Overview Matrix Lighting		32
LED		44
Halogen 230 V		75
Halogen 12 V		87
Fluorescent lamps		92
Starter		98

Coffee & Tea

Dishes		104
Storage & Presentation		114
Preparation		129
Machine accessories		137

Household goods & Decoration

Storage		146
Baking		151
Cooking		153
Decoration		162
Household goods		171

Small household appliances

Kitchen		178
Bathroom		184

Cleaning & Care

Coffee machines		196
Washing up		198
Kitchen cleaning		202
Washing & ironing		206
Descaler		210
Special cleaner		213

Energy & Technology

Safety		232
Smart Home		246
Comfort		248

NEW

Accessories for household appliances

Appliance connection, sanitary		258
Appliance connection, electrical		270
Washing & drying		274
Ironing		290
Refrigerating & freezing		295
Stove & glass ceramic hob		303
Extractor hood		321
Microwave		327
Overview Matrix Vacuum Cleaner Bags		334
Vacuum cleaner		338



The powerful Household brand

-  Lighting
-  Coffee & Tea
-  Household goods & Decoration
-  Small household appliances
-  Cleaning & Care
-  Energy & Technology
-  Accessories for household appliances



There are over 40 million households in Germany alone. Their requirements in regard to household accessories is huge and incredibly varied.

This can cover a wide variety of household devices such as washing machines, dryers, stoves that need to be connected up after purchase or moving home. What's more, the large number of lamps that, especially in terms of being environmentally aware, need replacing. Trends such as real coffee enjoyment, cooking and baking also create additional demand for useful and stylish accessories.

The Xavax range includes over 1,200 items for the perfectly organised household, and that from a single source.

You can benefit at the point of sale with Xavax, thanks to its clear assortment structure and distinct packaging. All this is topped off with a multitude of sales aids such as demo boards, posters, shop dividers, and brochures for the end user. This will help your customer quickly and easily find what they need.



Sales aids

Secondary Promotional Placement Generates Additional Sales

Alongside the initial placement in the sales display, many products are perfectly suited for secondary positioning next to the end device. The Xavax product range includes a number of items which can be sold alongside our major products. The products can be showcased perfectly on rotating stands or in practical cardboard displays, which help to greatly increase the number of impulse purchases.



Xavax – always present

The press is also impressed

Dwindling margins in the sale of terminal devices are forcing retailers to look for alternative sources of turnover. This topic is regularly dealt with by the trade press. Xavax products serve as a particularly good example. Additional purchase incentives can be created through secondary positioning, right through the entire range of white goods.

Trendthema Kaffee & Co. Geschenkkunden von Xavax

→ Unter seiner Hausgütermarke Xavax führt Hama zum einen praktische Produkte rund um das Thema Kaffee wie beispielsweise Aufbewahrungssysteme, damit Kapseln oder Kaffeepads immer griffbereit stehen, dabei aber schön ordentlich aufgedeckt sind. Im Xavax-Sortiment finden sich aber auch Artikel, die sich gut zum Verschenken eignen. Beispielsweise zu einem Geburtstag, als kleines Mitbringsel oder aktuell zum Muttertag.

Das Portfolio bietet eine Auswahl unterschiedlicher Kaffeetassen in trendiger Farbgebung und schicke Thermokannen sowie den Milchschäumer in Frägo, die ihren Kaffee gerne mit heißer Milch und Milchschaum genießen. Innerhalb von nur einer Minute schaum für Cappuccino oder Latte Macchiato herstellen.

Dafür wird das Edelstahl-Kännchen direkt auf dem Herz ausgenommen (Inklusion) erhitzt. Für perfekten Milchschaum bewegt man den integrierten Aufschäumer aus Kunststoff einfach auf und ab und im Nu steht genügend Milchschaum für etwa drei Tassen des köstlichen Heißgetränks zur Verfügung. Mit Schaum hergestellt werden, um beispielsweise Frische, Espressos oder kalten Kakao zu verfeinern.

Und Xavax hat noch weitere Geschenkkunden im Angebot. So zum Beispiel die Multi-Glaskücheplatte, die bei der täglichen Küchenarbeit unentbehrlich ist. Sie wird im Zweifelsfall unentbehrlich ist, falls optimal zur kratzfreien Abdeckung des Glaskeramik-Kochfelds oder als Spritzschutz an der Wand.

Witzig ist auch der Silikon-Ofen-Optik. Das rutschfeste Profil in der riesigen Mundöffnung des Frosches sorgt für festen und sicheren Halt an Topfgriffen und -henkeln. „Frosch“ ist für Links- und Rechtshänder geeignet und kann bis zu drei Kilogramm grammau abwiegen. Sie wollen mehr über die Produkte von Xavax erfahren? Gerne berät Sie das Team. Anfragen bitte an info@xavax.eu.

Viel nützliches Küchenzubehör
Multi-Glaskücheplatte, Gewürz-Milch-Aufschäumer, Milk-Booster, Silikon-Handschuh-Frosche

Xavax Spezialentkalker für jede Anwendung im Haushalt

→ Xavax, die Hausgütermarke von Hama, bietet für jedes Entkalkungsproblem die passende Lösung. So hat der Verkäufer bereits im Kundengespräch die Möglichkeit, das jeweils optimale Entkalterprodukt mitzuvorwählen. Kaffeeautomaten oder Dampfboiler, Zuzusatz einmaligen Universalentkalker. Geräte wie Wasser-Töpfe, Brauseautomaten, der sowie Filterkaffeemaschinen, die am besten geeignet ist. Speziell für Hochtemperatur-Entkalter, der am besten geeignet ist.

Modernes Lichtmarketing mit Xavax

Die Industrie definiert gerne Zielgruppen, um die eigene Kundenansprache genau auf dieses Klientel auszurichten. Dabei gibt es immer noch Produktgruppen, die jeder benötigt, und dazu gehören Leuchtmittel, die es heute in den ausgefallensten Varianten gibt. Wer sich als Händler differenzieren aufstellen möchte, kann mit dem vielfältigen Lampen-Sortiment von Xavax punkten.

Viele Verbraucher sind heute immer noch verunsichert, wenn sie im Handel nach Leuchtmitteln für die Ersatzbedürfnisse suchen. Die über Jahrzehnte eingetragenen Zusammenhänge zwischen Wattage, Helligkeit und Stromverbrauch haben in aktuellen Sortimenten keine Gültigkeit mehr. Stattdessen muss sich der Konsument mit Themen wie Farbtemperatur, Dimmbarkeit oder Lumen- und Kelvin-Angeboten auseinandersetzen und ist damit oftmals überfordert. Zudem wird die Vergleichbarkeit der Sortimente immer schwieriger, da jeder Anbieter dem Handel eine geschlossene Präsentation zur Verfügung stellt. Oft fällt dann aus Mangel an Informationen die Wahl des Kunden wieder auf herkömmliche Glühbirnen, sofern noch Bestände verfügbar sind, oder Halogenlampen. Bevor Lampen mit LEDs den Markt erobern, muss sich der Verbraucher auf den Weg machen, um die Vorteile der neuen Technologie zu verstehen. Für zusätzliche Ordnung sorgt ein praktischer Universalsockel mit Abblendeblende, der die Lampe sicher in der Leuchte hält und die Lampe vor dem Verschmelzen schützt. Der Sockel hebt die Lampe auf dem Leuchtmittel ab und ermöglicht es, die Lampe in der Leuchte zu platzieren, ohne sie zu beschädigen. Ein weiterer Vorteil ist die einfache Montage und Demontage. Die Lampe wird einfach in den Sockel gesteckt und ist sofort einsatzbereit. Ein weiterer Vorteil ist die einfache Montage und Demontage. Die Lampe wird einfach in den Sockel gesteckt und ist sofort einsatzbereit.

Wenig Aufwand – hohe Rendite

Die bessere Rendite sorgt das umfangreiche und innovative Sortiment von Xavax. Im Ladengeschäft richtig platziert, können häufig vom Nutzen überzeugen und greifen zu. Im Bereich der Leuchttechnik sind die Xavax-Produkte ein interessantes Sortiment. Es gibt Entkalter für empfindliche Wäscherezepte oder Dessous sowie Vibrationsdämpfer für erhöhte Soundabsorption und zur Geräuschminderung. Auch für Geschirrspüler und Wäschetrockner geeignet sind. Es gibt Schälbehälter für Abfalltrennung in Zu- und Abfluss. Wenn sich der Kunde beispielsweise für eine preisgünstige Wäschemaschine ohne Wasserstopp entscheidet, kann der Händler ein Xavax-Produkt empfehlen. Ein Xavax-Produkt, das die Wäsche schonender behandelt und die Trocknung beschleunigt. Ein Xavax-Produkt, das die Wäsche schonender behandelt und die Trocknung beschleunigt.

Umrüstung auf LED leicht gemacht

LEDs sind das Licht der Gegenwart. Die Leuchtdioden wandeln deutlich mehr Energie in Licht als in Wärme. Im Vergleich zu klassischen Glühbirnen sind sie wirtschaftlicher und umweltfreundlicher. Ein umfangreiches LED-Sortiment bietet Xavax.

Hilfestellung am POS
Maßstab von Xavax

Web portal

For end-customers – www.xavax.eu

The brand website is perfectly tailored to the requirements of end customers. We have particularly focussed on the search behaviour of users. In addition to detailed product information, the website also features many household tips. Helpful information on the website and effective search engine marketing generate many customer visits to the website and thereby also increase interest in Xavax products.



For retailers – www.hama.de/xavax

We have an independent web portal that is only available to retailers. All of the details about the product range, new products and advertising media can be found at <http://www.hama.de/brands/xavax>. Retailers must log in to the portal with a password in order to access this information. Passwords can easily be requested online directly on the website's homepage. The structure is identical to the structure of the catalogue, which makes it easy to find your way around the portal.

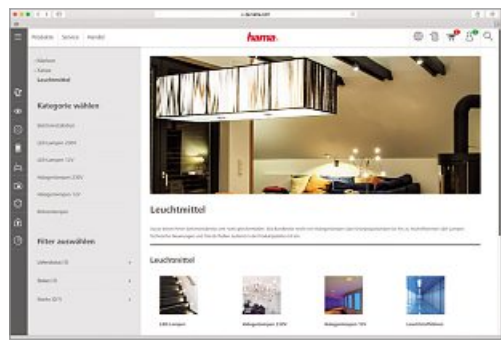

Cleaning & Care
Energy & Technology
Accessories for household appliances





Lighting

Brilliant Test Scores	12
Advertising Media	22
Overview Matrix	32
Range	43
LED	44
Halogen 230 V	75
Halogen 12 V	87
Fluorescent lamps	92
Starter	98

Lighting by Xavax

Energy-saving regulations have led to rapid advances in the development of energy-saving lighting. The result: the LED lamp.

Quality comes first and foremost from the inside. And Xavax is always up-to-date. The proof comes from the October 2015 report of the independent German product testing agency "Stiftung Warentest". The winning entry, rated "very good", came from Xavax. This is the quality standard that our entire product range, comprising over 80 different LED lights, satisfies.

So we can help you refit any lamp to be energy-efficient in no time at all. Halogen lamps, fluorescent tubes, and other special lights for household appliances complete the product palette of Xavax.





Visible light spectrum comparison

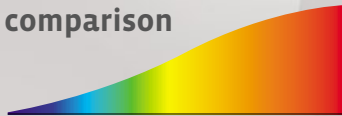

Light bulb

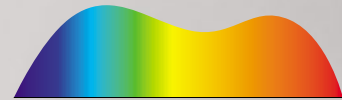

LED - Lamp / Tube

LED lamps advantages

- Energy efficiency
- Homogeneous visible light spectrum
- Long service lifetimes
- Five-year guarantee on all Xavax LED lights of the High Line series



The packaging is designed to help customers orientate themselves and make a decision as soon as possible.



Cool. Die Viva-Lite leuchtet tageslichtweiß. Farbnuancen sind bei ihr gut zu unterscheiden.



Die Besten für Bun

Lampen Schlechtes Licht lässt Farben oft blass aussehen. Die richtigen LED-Lampen bringen Bunt unverfälscht zum Leuchten.

Kritik kann sooo frustierend sein: Da hat der Heimwerker tagelang die Wohnzimmerwand renoviert und liebevoll mit Lehmputz gestaltet – und dann kommt die Liebste das Ergebnis mit „Sieht irgendwie gräulich aus“. Dabei soll der Lehmputz namens „Ayers Rock“ das Rot des berühmten australischen Felsens an die Wand zaubern. Schuld am Malheur ist die Beleuchtung. Die lässt sich aber schnell wechseln. Kaum sind die schlechten Sparlampen gegen hochwertige getauscht, erscheint der Lehm auch im Auge der Partnerin in angenehmem Rotbraun.

Schöner Teppich, brillantes Bild

Vor dem Schminkspiegel im Bad, über dem Wohnzimmerteppich, am Zehchentisch oder vor einem Bild: Gute Lampen sollen mit ihrem Licht an möglichst vielen Stellen Farben naturgetreu erscheinen lassen. Glühbirnen können Farbtöne problemlos wiedergeben. Doch wegen ihres hohen

FOTOS: STIFUNG WARENTEST

Stromverbrauchs versch... und näch. Moderne LED... optimale Alternative. Da... im Test lässt Bunt gen... erscheinen wie das vom G... drein sind die Licht emittie... echte Sparlampen. Sie lebe... gleich zur Glühlampe senke... kosten um mehr als vier Fün... LED-Lampen – von warmw... lichtweiß – geprüft, außerde... paktleuchtstofflampen.

Eine sehr gut und zwei Funz

Testsieger Xavax High Line LED... gar das Qualitätsurteil sehr gu... kostet 11 Euro, ihre Farbwiederga... gut, die Lichtausbeute sehr hoch... fast allen anderen Prüfpunkten s... sie sehr gut ab. Doch nicht jede Sp... ist einen Tipp wert. Von den 15 Kan... erweisen sich zwei in der Dauerprüf... messen an ihrer Deklaration – als trü... zeln. Die Gesamtnoten lauten ausreic... Es stehen aber genügend empfehl... werte Lampen zur Auswahl: neben der... guten Sieger-LED zehn gute. Es gibt si... jeden Bereich der Wohnung – mit gem... cher, warmer Lichtfarbe für die Kusch... ede oder mit aufmunterndem Tageslic... weiß fürs Arbeitszimmer.

Wenn es auf Farbnuancen ankommt

Unabhängig davon, ob die Beleuchtung... eher warm oder kalt wirkt, gibt es Lampen... deren Licht die verschiedenen Farbtöne im... Raum realitätsnah erscheinen lässt. Der... Betrachter kann dann feine Nuancen wahr... nehmen. „Die Farbwiedergabe ist das... wichtigste Kriterium für eine hohe Licht... qualität“, sagt der Projektleiter des Tests... Peter Schick. Dieser Prüfpunkt steht in der... Testtabelle an erster Stelle. Mit welcher Qualität die Farben von Ob... jekten wiedergegeben werden, beschreibt

Testsieger Xavax. Ihr warmweißes Licht gibt Farben sehr gut wieder.



Brilliant Test Scores for Xavax Lamps

Impressive Across the Board: Xavax's High Line LED lamp is THE winner in the Stiftung Warentest product test.

tes



Spot an. Der Osram LED-Spot erzielte im Test die beste Farbwiedergabe.

Lampen

schwinden sie nach
-Lampen sind die
Licht der Besten
so unverfälscht
Lülfaden. Oben-
erenden Dioden
lange. Im Ver-
sie die Strom-
tel. Wir haben
weiß bis tages-
m zwei Kom-

eln

erzielt so-
t. Die LED
be ist sehr
Auch in
schneidet
arlampe
didaten
ng-ge-
ne Fun-
hend.
lens-
sehr
e für
ütli-
hel-
ht-

der Farbwiedergabeindex. Er steht als Ra-Wert auf der Verpackung (oft auch englisch als CRI: Color Rendering Index). Je höher er ist, desto besser. Maximal kann eine Lampe den Ra-Wert 100 erreichen. Unsere Vergleichswerte der meisten bislang getesteten Sparlampen liegen oft unter 80. Peter Schick erläutert: „Für eine sehr gute Note im Prüfpunkt Farbwiedergabe muss der Vergleichswert für 15 verschiedene Testfarb-Spot Osram LED Parathom Pro Par 16 Cool White erzielt mit 96 den besten Wert.“

Die Farbwiedergabe haben wir bewertet, die Lichtfarbe hingegen nicht. Die ist Geschmackssache. Wenn die Lampe zu einer gemütlichen Atmosphäre beitragen soll – wie etwa im liebevoll renovierten Wohnzimmer –, sollte „warmweiß“ auf ihrer Verpackung stehen. Zehn solche Lichtquellen, darunter zwei Spots, sind im Test.

Warm oder kühl – Kelvin zeigt

Wenn eine Lampe einen warmen Eindruck erzeugt, liegt das an ihrer Lichtfarbe, die als Farbtemperatur deklariert wird. Sie beschreibt, ob das Licht eher gelblich-warm ▶

Unser Rat

Strahlender Testsieger ist die **Xavax High Line LED-Lampe** für etwa 11 Euro, die ein gemütliches warmweißes Licht erzeugt. Wer aufmunterndes Tageslichtweiß bevorzugt, wählt die **Viva-Lite Fullspectrum Daylight LED** (zirka 30 Euro) oder die preiswertere **Ikea Ledare LED 5000 Kelvin** (etwa 8 Euro). Um Bilder oder bunte Wohnaccessoires in Szene zu setzen, empfiehlt sich der **Spot Osram LED Parathom Pro Par16 Cool White** (zirka 18 Euro).

Die Richtige finden

Die Lampenvielfalt im Handel ist riesig. So führt Ihre Suche zum Erfolg:



E 27

1. Sockel beachten. Oft passt E27 – Schraubgewinde mit 27 Millimeter Durchmesser – in die Fassung. Auch E14 und GU10 (siehe Foto oben) sind weit verbreitet.

Tipp: Im Zweifel die alte, kaputte Lampe zum Einkauf mitnehmen.



330 Lumen

2. Lumen wählen. Die Zahl gibt an, wie viel Licht Lampen liefern. Faustregel zum Vergleich mit den von Glühlampen vertrauten Werten: Deren Watt-Zahl mal zehn = Lumen. Je höher die Wattzahl, desto großzügiger muss man „aufrunden“: So entsprechen 75 Watt etwa 900 Lumen.



2700 Kelvin

3. Licht aussuchen. Warmweiße Lampen leuchten mit einer Farbtemperatur von höchstens 3300 Kelvin (kurz K), tageslichtweiße mit mehr als 5300 K. Dazwischen gibts neutralweiße. Wichtig: Auf Farbwiedergabe (hoher Ra-Wert) achten.



4. Dimmbar oder nicht. Dieses Zeichen sagt, dass die Lampe dimmbar sei. Aber: Keine so

deklarierte Lampe im Test funktionierte mit jedem unserer Dim-

In the current issue (10/2015) of the Stiftung Warentest magazine, the Xavax High Line LED lamp (item no. 112198) came in first out of 13 LED lamps tested.

xavax



TESTSIEGER

Stiftung Warentest
test

Lichttechnik,
Energieeffizienz: **SEHR GUT (1,5)**
Praxistest: **SEHR GUT (1,2)**
Deklaration: **SEHR GUT (1,4)**
Sicherheit: **SEHR GUT (1,0)**

Im Test: 15 Sparlampen
Ausgabe 10/2015
www.test.de

15PL25

Item No. 00112198

“... The top-scoring Xavax High Line LED even received the ‘very good’ quality rating. The LED costs 11 Euro, its colour reproduction is very good and the light yield is very high. It also performed well in almost all other test criteria ...”

“... The brilliant winner is the Xavax High Line LED lamp for approx. 11 Euro, which provides a comfortable warm white light ...”

„... LED technology has come a long way. The many good reviews in the table show this.

A very good declaration on the packaging, on the other hand, is rare. We only saw one on the lamps from Xavax and Ledon ...”



The Best: the values were even surpassed in the test

Greater light output

Description Xavax: 806 lm

Measured: **822 lm**

Higher colour reproduction index

Description Xavax: Ra 90

Measured: **Ra 94**

Greater angle of radiation

Description Xavax: 240°

Measured: **250°**



test Sparlampen

E27-Schraubsockel, warmweiß

	Xavax High Line LED Art.-Nr. 00112198	Ledon LED Lamp A66 ³⁾ Art.-Nr. 28000286	Vosla VosLED EAN: 4 250686 552485	GreenLED ML EAN: 4 015 153112
Mittlerer Preis ca. (Euro)	11,00	19,10 ⁴⁾	20,00	7,00
Stromkosten für eine Lichtmenge von 1 Million Lumenstunden ca. (Euro) ¹⁾	3,20	4,10	3,00	3,10
test - QUALITÄTSURTEIL	100% SEHR GUT (1,5)	GUT (1,7)	GUT (1,8)	GUT (1,9)
LICHTTECHNIK, ENERGIEEFFIZIENZ	60% sehr gut (1,5)	gut (2,0)	sehr gut (1,5)	gut (1,8)
Farbwiedergabe	++	+	sehr gut (1,5)	gut (1,8)
Lichtausbeute	++	+	+	+
Startverhalten	++	+	++	++
Helligkeit bei Kälte und hoher Temperatur	+	+	++	++
PRAXISTEST	20% sehr gut (1,2)	sehr gut (1,2)	sehr gut (1,2)	sehr gut (1,1)
Dauerprüfung	++	++	++	++
Flimmern	++	++	++	++
Geräusch	++	++	++	++
DEKLARATION	20% sehr gut (1,4)	sehr gut (1,3)	befriedigend (3,2) ⁵⁾	befriedigend (2,8) ⁶⁾
SICHERHEIT	0% sehr gut (1,0)	sehr gut (1,0)	sehr gut (1,0)	sehr gut (1,0)
TECHNISCHE MERKMALE				
Farbtemperatur gemessen ca. (Kelvin)	2700	2710	2640	2800
Lichtstrom deklariert / gemessen nach 1500 Brennstunden (Lumen)	806 / 822	800 / 838	605 / 538	810 / 902
Leistungsaufnahme deklariert (Watt)	9,2	13	605 / 538	2740
Lichtausbeute nach 1500 Brennstunden gemessen ca. (Lumen/Watt)	88	68	5,5	11
Farbwiedergabeindex gemessen aus 8 Farbindizes (Ra oder CRI) / 15 Farbindizes	94 / 92	90 / 86	94	89
Wirkung auf Schlaf-wach-Rhythmus gemessen (% von Glühlampenlicht) ²⁾	90	95	91 / 89	82 / 77
Ausstrahlungswinkel deklariert / Halbwertswinkel gemessen (Grad)	240 / 250	260 / 290	320 / 284	95
Länge / Durchmesser gemessen ca. (mm)	120 / 60	132 / 68	112 / 60	117 / 60
Dimmbar laut Deklaration	<input type="checkbox"/>	<input type="checkbox"/>	<input type="checkbox"/>	<input type="checkbox"/>

Bewertungsschlüssel der Prüfergebnisse:
 ++ = Sehr gut (0,5–1,5) + = Gut (1,6–2,5)
 ○ = Befriedigend (2,6–3,5) ⊖ = Ausreichend (3,6–4,5)
 – = Mangelhaft (4,6–5,5)
 Bei gleichem Qualitätsurteil Reihenfolge nach Alphabet.
 *) Führt zur Abwertung (siehe „So haben wir getestet“ auf Seite 75).
 ■ = Ja. □ = Nein. K. A. = Keine Angabe.

1) Berechnet mit einem Strompreis von 28 Cent/Kilowattstunde und den nach 1500 Brennstunden gemessenen Werten von Lichtstrom (Lumen) und Leistungsaufnahme (Watt). Zum Vergleich: Bei einer 60-Watt-Glühlampe (mit ca. 600 Lumen) liegen die Stromkosten bei 26 Euro.
 2) In den Abendstunden sind vor dem Einschlafen niedrige Werte empfehlenswert. Ermittelt anhand des Wirkungsfaktors für Melatonin-suppression in Anlehnung an DIN V 5031, Teil 100.

3) L
 4) V
 5) K
 mit
 6) lm
 ten



Stiftung Warentest test 	Lichttechnik, Energieeffizienz: GUT (1,7) Praxistest: SEHR GUT (1,1) Deklaration: SEHR GUT (1,1)
	Im Test: 17 LED-Lampen Ausgabe 12/2015 www.test.de

15VB71

Item No. 00112203

Another "Very good" for Xavax LED light

In the December 2015 newsletter of the independent German product testing agency "Stiftung Warentest", our High Line LED candle bulb (item no. 00112203) was awarded the quality rating of VERY GOOD.

"Our recommendation: [...] the matte Xavax High Line (9 euros, approx. 6.50 pounds), which lets colours appear very natural..."

"... The maximum possible CIE Ra value of 100 has been attained only by incandescent bulbs so far. However, at 91, the LED light from Xavax comes so close to it that its light cannot be distinguished from that of an incandescent bulb by the naked eye..."

Funzeln, Flimmern und Brummen
Mehrere Macken zeigten die fünf Lampen, die auf dem Prüfstand nicht gut wegkamen. Die Modelle von Hellweg und Hornbach flimmerten von Anfang an. Die Hornbach-Lampe brumme zudem leise vor sich hin. In einem Kronleuchter mit vielen Kerzen kann das ziemlich nerven. Die LEDs

von Müller-Licht, dm und Lightloren sehr schnell an Helligkeit. funzelig wurde es bei hoher Temp etwa in kleinen geschlossenen Le Bei den Lampen von Müller-Licht u trat zudem eine ölige Flüssigkeit am aus. Die war weder giftig noch stört den Betrieb – ein Mangel ist sie trotz



test Lampen in Kerzenform (300 bis 470 Lumen deklariert, E14)

	Vosla LED-Kerze Art.-Nr.: 50021	Melitec LED-Lampe L88 Art.-Nr.: L88	Xavax High Line LED Art.-Nr.: 00112203	Ledon LED Art.-Nr.: 28000510	Mega LED C Dimmbar Art.-Nr.: MM21705
Mittlerer Preis ca. (Euro)	6,50	7,00 ³⁾	9,00	14,00	15,00
Stromkosten für eine Lichtmenge von 1 Million Lumenstunden ca. (Euro) ¹⁾	2,60	3,10	3,90	4,10	3,30
test - QUALITÄTSURTEIL	100% SEHR GUT (1,3)	SEHR GUT (1,5)	SEHR GUT (1,5)	GUT (1,6)	GUT (1,6)
LICHTTECHNIK, ENERGIEEFFIZIENZ	60%	sehr gut (1,3)	gut (1,6)	gut (1,7)	gut (1,8)
Farbwiedergabe	+	+	++	+	+
Lichtausbeute	++	++	+	+	++
Startverhalten	++	++	+	++	++
Helligkeit bei hoher Temperatur	++	++	+	++	++
PRAXISTEST	20%	sehr gut (1,1)	sehr gut (1,1)	sehr gut (1,5)	sehr gut (1,1)
Dauerprüfung	++	++	++	++	++
Flimmern	++	++	++	++	++
Geräusch	++	++	++	++	++
DEKLARATION	20%	sehr gut (1,3)	sehr gut (1,5)	sehr gut (1,2)	sehr gut (1,4)
TECHNISCHE MERKMALE					
Farbtemperatur gemessen ca. (Kelvin)	2730	2800	2730	2770	2740
Lichtstrom deklariert / gemessen nach 1500 Brennstunden (Lumen)	300 / 309	470 / 485	470 / 483	400 / 404	470
Leistungsaufnahme deklariert (Watt)	3	6	6,9	6	5,5
Lichtausbeute nach 1500 Brennstunden gemessen ca. (Lumen/Watt)	109	89	72	68	83
Farbwiedergabeindex gemessen aus 8 Farbindizes (Ra oder CRI) / 15 Farbindizes	92 / 89	88 / 84	93 / 91	85	83
Wirkung auf Schlaf-wach-Rhythmus gemessen (% von Glühlampenlicht) ²⁾	95	80	90	91 / 88	83 / 78
Länge / Durchmesser gemessen ca. (mm)	115 / 35	110 / 37	112 / 38	111 / 36	102 / 37
Dimmbar	<input type="checkbox"/>	<input type="checkbox"/>	<input type="checkbox"/>	<input type="checkbox"/>	<input type="checkbox"/>

Bewertungsschlüssel der Prüfergebnisse:
 ++ = Sehr gut (0,5–1,5), + = Gut (1,6–2,5),
 ○ = Befriedigend (2,6–3,5), ⊖ = Ausreichend (3,6–4,5),
 – = Mangelhaft (4,6–5,5).

Bei gleichem Qualitätsurteil Reihenfolge nach Alphabet.
 *) Führt zur Abwertung (siehe „So haben wir getestet“ auf Seite 79).
 ■ = Ja, □ = Nein.

1) Eine Million die kerzen kömlich abgeben. (Strompreis)

Coffee & Tea
Household goods & Decoration
Small household appliances
Cleaning & Care
Energy & Technology
Accessories for household appliances

Tested quality

Quality products and even a testing award don't just happen by themselves. Well conceived product management, discerning selection of materials and components, and above all, extensive testing procedures are necessary to ensure lasting quality.

Xavax lamps are tested constantly even during production against very strict criteria.

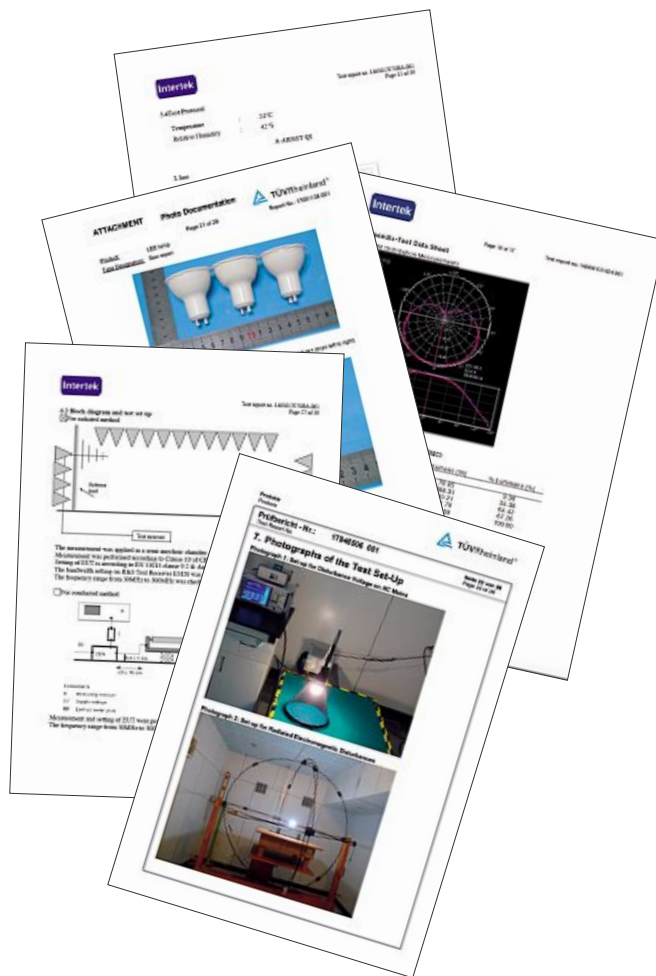

The latest trends in technology

Developments in the field of lighting, and particularly LED technology, show no signs of stopping. When buying long-lasting products that will be used for years, it's particularly important to make sure that they are state of the art. This also benefits the variety of products offered.

LED-T8-tubes

Older fluorescent tubes can be replaced in next to no time because the necessary starter replacement is included with the product.

Available in lengths of 60, 120 and 150 cm.

- Efficient
- Instantly bright
- Up to 30 000 h lifetime
- Resistant to cold
- Homogeneous visible light spectrum
- Instant start without flickering
- Small risk of breakage
- Easy replacement in current socket

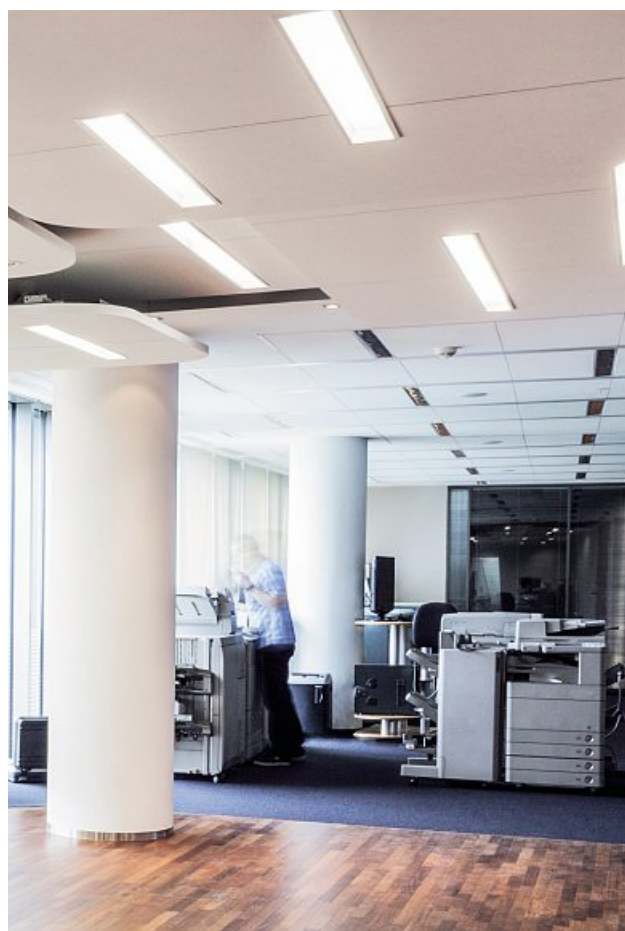
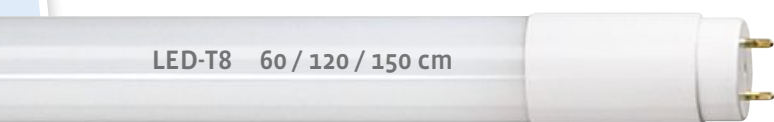



mehr Licht durch
318°
 Abstrahlwinkel
 beam angle
 more Light by

Filament

- Retrofit look. For nostalgic fans of incandescent lamps
- Clear glass, with visible filaments
- Same design and look as incandescent lamps
- Large lighting angle

All glass

- Attractive design without plastic collar
- Matte glass
- Same design as incandescent lamps
- Large lighting angle



mehr Licht durch
300°
 Abstrahlwinkel
 beam angle
 more Light by

The most important criteria in choosing lighting

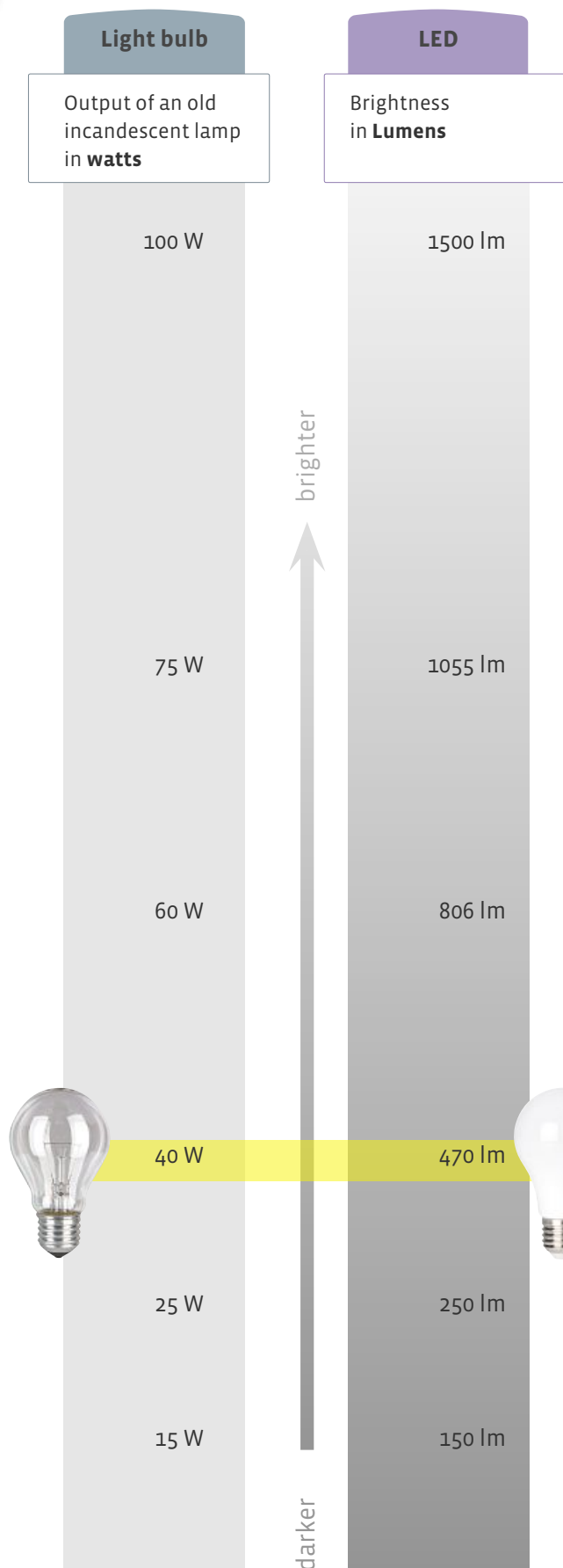

Brightness in lumens

The LED light has long since established itself on the market. Nevertheless, in the minds of consumers, the familiar value used for decades to describe the brightness of a light is the watt rating of the incandescent bulb.

However, the “lumen” is the scientific unit that describes the actual brightness independently of the type and wattage of the lamp.

Angle of radiation

In addition to standard LED lamps with a lighting angle of approx. 135°, the High Line series also features special versions with a lighting angle of over 300°. This provides much more uniform illumination.

At the same time, they are even more efficient because the LED’s lighting power is used all round. The technology used is either a special arrangement of LEDs or a special prism that deflects the light in the appropriate directions.

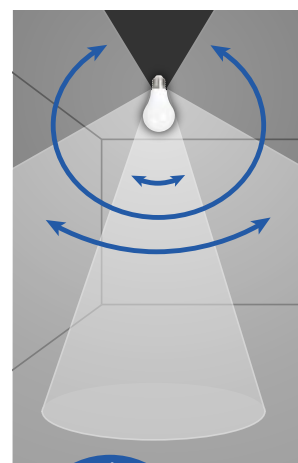



The colour reproduction index as an Ra value

The higher the Ra value (colour reproduction index), the more naturally and realistically a lamp reproduces the colours of the illuminated objects (food, furniture, clothing, etc.). The standard by which all things are measured is sunlight, whose Ra value is 100.

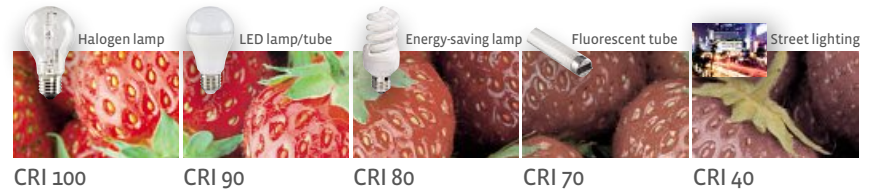

CRI 100

CRI 90

CRI 80

CRI 70

CRI 40

Colour temperature in Kelvin

Lamps with high blue levels are particularly good for lighting workplaces. They have been proven to boost concentration and raise spirits during the winter months. Their colour temperature is 6500 K (Kelvin). In comparison, warm white lamps have about 2700 K.

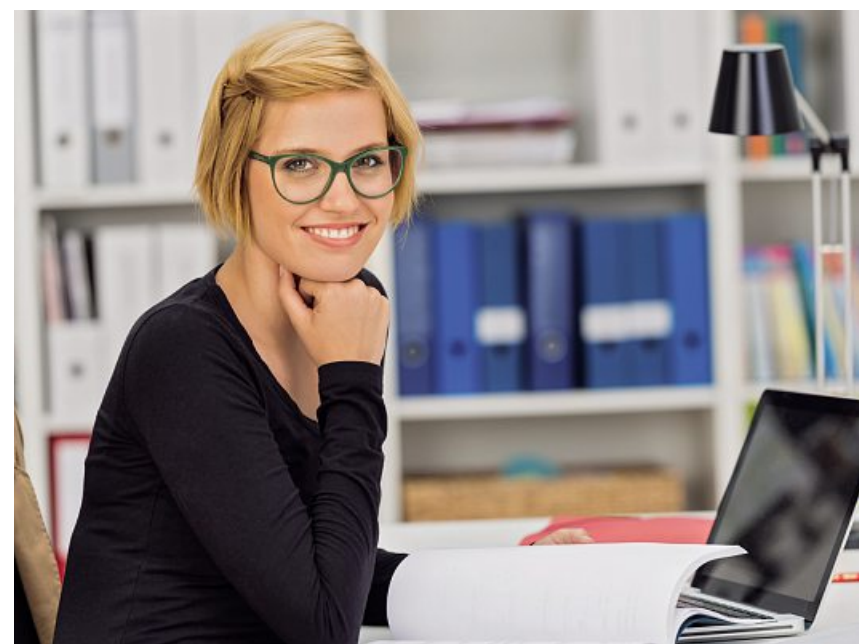
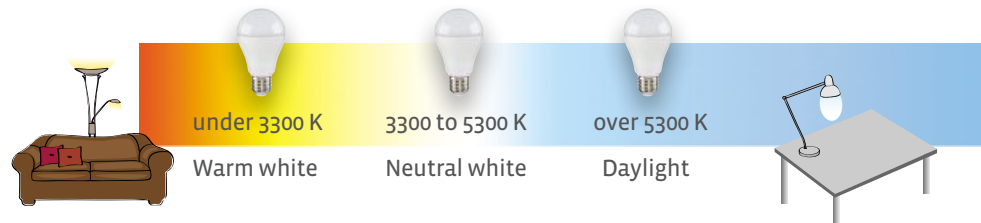

Daylight lighting is particularly well suited to workplaces, since it improves concentration.

xavax

TESTSIEGER



Lichttechnik, Energieeffizienz: **SEHR GUT (1,5)**
Praxistest: **SEHR GUT (1,2)**
Deklaration: **SEHR GUT (1,4)**
Sicherheit: **SEHR GUT (1,0)**
Im Test: 15 Sparlampen
Ausgabe 10/2015
www.test.de

Art. Nr. 00112198



Gleiche Bauform wie Glühlampen
Passende Leuchtmittel für Ihre Lampen

Filament



Retrofit Optik. Für nostalgische Anhänger der Glühlampe ;-)
Klar, mit sichtbaren Leuchtfäden
Gleiche Bauform und Optik wie Glühlampen

Vollglas



Ra-Wert

Je höher der RA-Wert (Farbwiedergabeindex) eines Leuchtmittels, desto natürlicher und realistischer gibt es die Farben der beleuchteten Gegenstände (Lebensmittel, Möbel, Kleider...) wieder. Das Maß der Dinge ist das Sonnenlicht mit RA 100.



Advertising Media

Informationen at the POS

In order to offer customers optimal information at the point of sale, Xavax offers an array of end-user brochures, posters and even demonstration systems.

xavax

Abstrahlwinkel

Die neuen LED-Leuchtmittel erzeugen einen größeren Leuchtwinkel

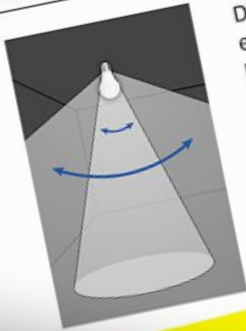

270° Abstrahlwinkel
mehr Licht durch mehr Lichtkegel
more LightKegels

240° Abstrahlwinkel
mehr Licht durch mehr Lichtkegel
more LightKegels

300° Abstrahlwinkel
mehr Licht durch mehr Lichtkegel
more LightKegels

Ohne Kunststoffkragen, dadurch schöne Optik

Mattes Glas

Gleiche Bauform wie Glühlampen

Großer Leuchtwinkel

Helligkeit und Lichtfarbe Umdenken beim Leuchtmittelkauf

Aus Watt wird Lumen

Leistung einer ehemaligen Glühlampe in Watt

100 W

75 W

60 W

40 W

25 W

15 W

Helligkeit in Lumen

1500 lm

1055 lm

806 lm

470 lm

250 lm

150 lm

heller

dunkler

Beispiel

Die Lichtfarbe in Kelvin

gemütliche Atmosphäre

unter 3300 K

Warmweiß

3300 bis 5300 K

Neutralweiß

über 5300 K

Tageslicht

konzentriertes Arbeiten





**Board
Top-Scoring**

Notice sign
„Testsieger Stiftung Warentest“
Item No. 00112198.

290 x 180 mm
Item No. 00098493



**Board
Action-Board Top-Scoring**

Notice sign
„Testsieger Stiftung Warentest“
Item No. 00112198

- Display stand not included in delivery

210 x 297 mm
Item No. 00298007



Example

**DOWNLOAD
AND PRINT
YOURSELF**

Gleiche Bauform wie Glühlampen Passende Leuchtmittel für Ihre Lampen

Filament



Retrofit Optik. Für nostalgische Anhänger der Glühlampe ;)

Klar, mit sichtbaren Leuchtfäden

Gleiche Bauform und Optik wie Glühlampen

Vollglas



Ohne Kunststoffkragen, dadurch schöne Optik

Mattes Glas

Gleiche Bauform wie Glühlampen

Großer Leuchtwinkel

Abstrahlwinkel

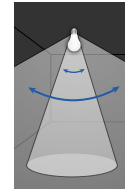

Die neuen LED-Leuchtmittel erzeugen einen größeren Leuchtwinkel



Board Filament, All Glass, Angle of radiation

Explanation of the advantages of filament and all glass LED lamps, as well as the advantages of a large angle of radiation.

For Tego 1 m

980 x 230 mm

Item No. [00298003](#)

980 x 300 mm

Item No. [00098477](#)

For Tego 1,25 m

1230 x 230 mm

Item No. [00298004](#)

1230 x 300 mm

Item No. [00098478](#)

Für realistische Farben und die Stimmungsatmosphäre zuständig Farbwiedergabe und Farbtemperatur

Ra-Wert

Je höher der RA-Wert (Farbwiedergabeindex) eines Leuchtmittels, desto natürlicher und realistischer gibt es die Farben der beleuchteten Gegenstände (Lebensmittel, Möbel, Kleider...) wieder. Das Maß der Dinge ist das Sonnenlicht mit RA 100.



Warmweiß, Neutral, Tageslicht

Leuchtmittel mit hohem Blauanteil sind besonders gut zur Beleuchtung von Arbeitsplätzen geeignet. Sie steigern nachweislich die Konzentration und wirken in den Wintermonaten Stimmungsaufhellend. Ihre Farbtemperatur liegt bei 6500 K (Kelvin). Zum Vergleich: warmweiße Lampen haben ca. 2700 K.



Board Colour Reproduction and Colour Temperature

Understanding colour reproduction indexes (Ra values) and colour temperatures (Kelvin)

For Tego 1 m

980 x 230 mm

Item No. [00298005](#)

980 x 300 mm

Item No. [00098479](#)

For Tego 1,25 m

1230 x 230 mm

Item No. [00298006](#)

1230 x 300 mm

Item No. [00098480](#)



Die Helligkeit in Lumen

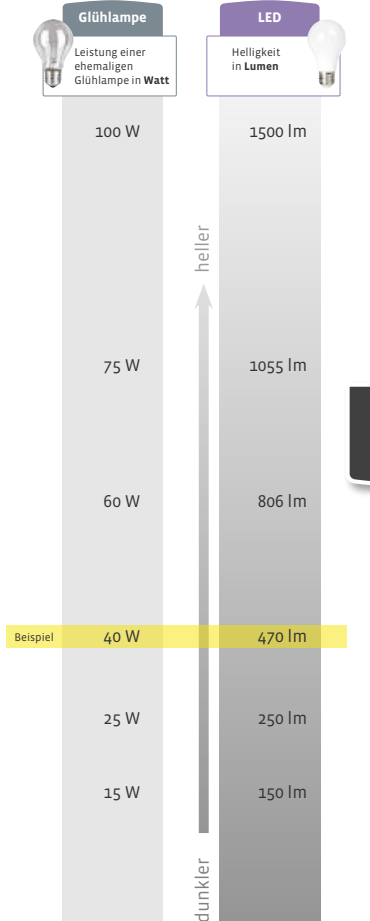

Shelf Divider Brightness in Lumens

Showing the relationship between the watt specification for a conventional incandescent lamp and the actual brightness in lumens.

300 x 1000 mm
Printed on both sides
For hanging up
Item No. 00098481

**PRINTED ON
BOTH SIDES**



For Shelf Divider Banner holder

For hanging in the columns of gondola shelves and shop walls.
Item No. 00098670

**Board
LED Angle of radiation**

Explanation of the benefits of greater angles of radiation.

For Tego 1 m
980 x 230 mm
Item No. 00098245

For Tego 1,25 m
1230 x 230 mm
Item No. 00098248

**Board
Lumens, Kelvin**

Showing the relationship between the watt specification for a conventional incandescent lamp and the actual brightness in lumens.

290 x 180 mm
Item No. 00098226

**Board
LED Tubes**

Explains the benefits of LED T8 tubes over conventional fluorescent tubes.

561 x 943 mm
For Tego 1 and 1,25 m
Item No. 00098309



Demo boards for lamps

Attractive presentation of the lamps. The customer can get an idea of the lighting effects.

With the base adapters (sold separately), they can be used for many types of lamps:

- GU10: Item No. 00098324
- G9: Item No. 00098325
- E14: Item No. 00098326

The appropriate power cable (Item No. 00096956) must be ordered separately.

Online tool can be used to create product signs.

**CONNECTION CABLE
AVAILABLE SEPARATELY**

ITEM No. 0096956



Photo Backgrounds

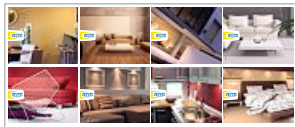

Scanner Labels



Demoboard Style 1

Matching photo backgrounds available

For Tego 1 m

1000 x 220 x 245 mm
Lamp sockets: 2x E27, 2x E14, 2x GU10 and 1x G13
Item No. 00098952

For Tego 1,25 m

1250 x 220 x 245 mm
Lamp sockets: 4x E27, 2x E14, 2x GU10 and 1x G13
Item No. 00098953

Demoboard Style 2

For Tego 1 m

990 x 210 x 205 mm
Lamp sockets: 6x E27 and 1x G13
Item No. 00098731

For Tego 1,25 m

1240 x 210 x 205 mm
Lamp sockets: 8x E27 and 1x G13
Item No. 00098732



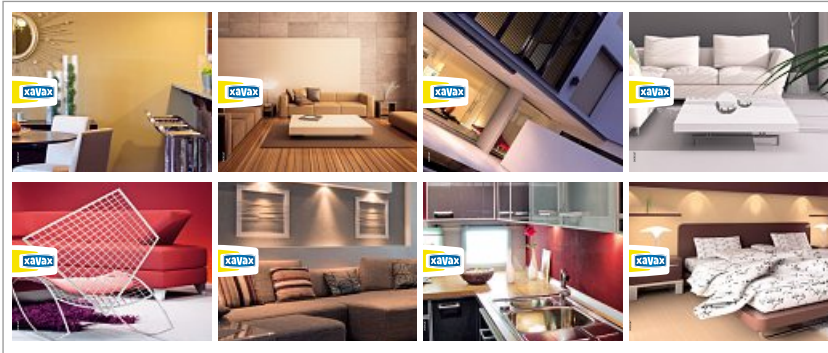

Set Photo Backgrounds

Image set consisting of eight different subjects (two images each). They help customers to better assess the lamps.

For Tego 1 m

For Demoboard Item No. 00098952

Item No. 00098167

Für Tego 1,25 m

For Demoboard Item No. 00098953

Item No. 00098179

xavax		LED	
LED-Lampe, Glühlampenform, warmweiß		00112190	
Fassung	E27	230 V	Spannung
Leistung	16 W	± 100 W	Glühlampe
Helligkeit	1521 lm	2700 K	Lichtfarbe
EEK*	A+		
* Energie-Effizienzklasse: Werteskala von A++ bis E, Bestwert ist A++		24,99 €	
		Halogen	
		weiß	00112154
		12 V	Spannung
		40 W	± 70 W Glühlampe
		856 lm	2900 K Lichtfarbe
		EEK*	C
		* Energie-Effizienzklasse: Werteskala von A++ bis E, Bestwert ist A++	
		2,49 €	

For Demoboard Scanner Labels

An easy-to-use online tool can be used to create labels for the chosen display assortment. After choosing the item numbers, the technical specifications are automatically filled out. Price and currency can be adjusted individually. Once finished, the label is sent by e-mail ready for printing.

Quick guide

- 1. Logging in**

Enter this address in your browser: hss.hama.de
 User name: Xavax
 Password: Light
- 2. Create label**
 - In the **Ordner** click on the **Einkaufswagen** and then on the **Listen-Symbol** .
 - Select lamps by item number. If you wish, change the price
 - and the currency.
 - Then click on **"Produkt erstellen"** klicken.
 - The label is automatically created with all of the data, and a preview is displayed.
- 3. Ordering labels**
 - Click on **"Softproof annehmen"** and then on **"zur Bestellung hinzufügen"**.
 - If you require another label, then click on **"weiter Bestellen"**.
 - Once you have all the labels you need, complete the process by clicking on **"Bestellen"**.
 - Then all that's required is your name and e-mail address (print files recipient). Please remember to print out the labels in the original size.

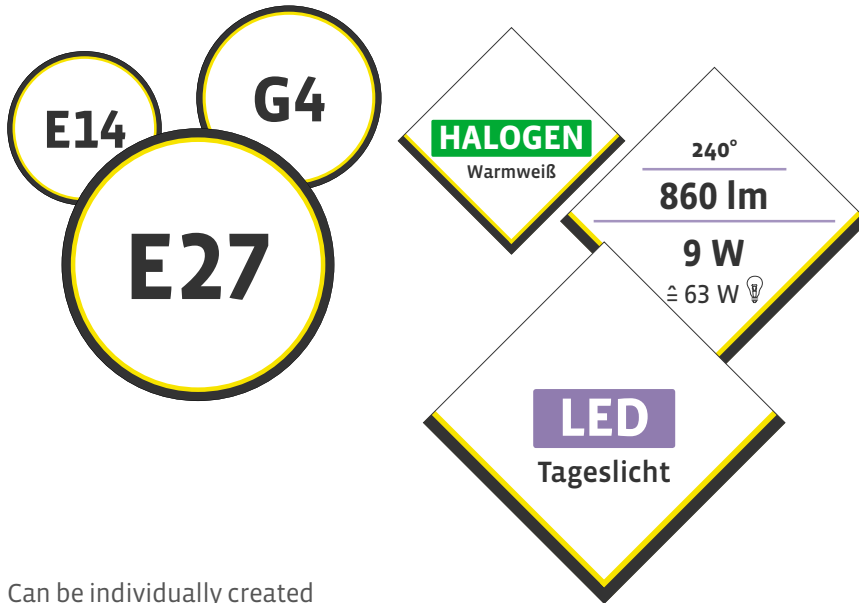

Poster
Canopy signs

You can best assess a bulb's performance with a lamp. With the right signs, customers can quickly find the products they need. They also get all the important technical information at a glance.



Can be individually created





Board Navigation bars

Help customers to orientate themselves and choose the right lamp from the sales display.

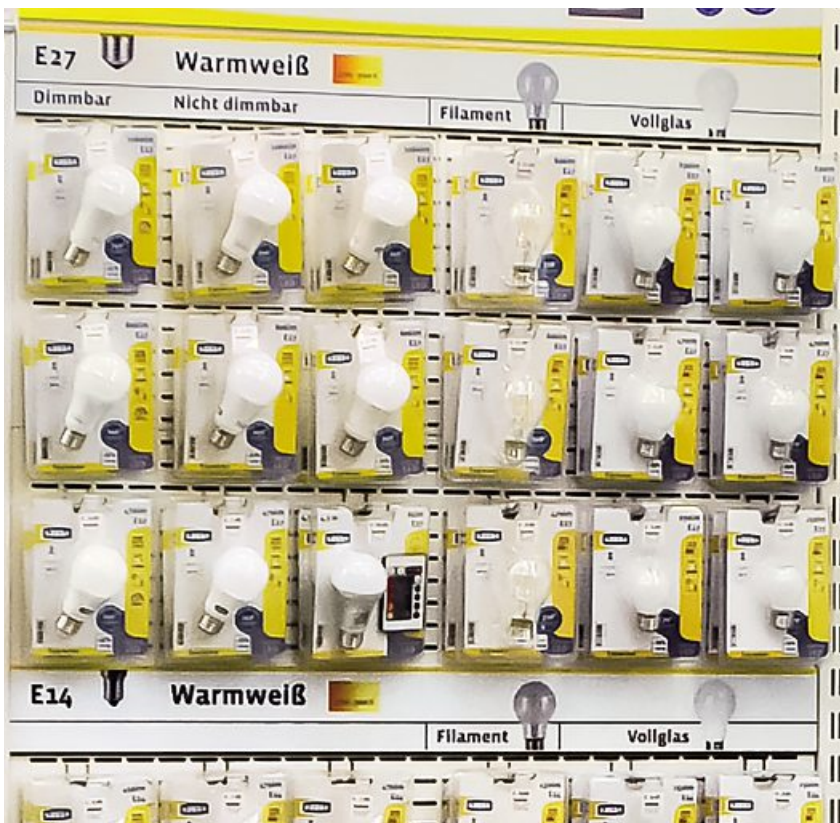

Custom-tailored to display assortment

- Leuchtmittel
- Kerze & Tee
- Haushaltswaren & Deko
- Haushaltskleingeräte
- Reinigung & Pflege
- Energie & Technik
- Hausgeräte-Zubehör

... ihre Farbwiedergabe ist sehr gut, die Lichtausbeute sehr hoch ..."

- 806 lm
- Ra 90
- 240°



We produce media for special purposes (such as for adverts) upon request



HALOGEN 230 V

Socket		Globe	Standard
E27		<input checked="" type="checkbox"/>	<input checked="" type="checkbox"/>
	<input type="checkbox"/>	<input type="checkbox"/>	<input type="checkbox"/>

LED 230 V

Socket	Lamp form					
	Globe	Standard	Tropic	Kern	Reflektor	Stecksockel
E27		<input checked="" type="checkbox"/>	<input checked="" type="checkbox"/>	<input type="checkbox"/>	<input type="checkbox"/>	<input type="checkbox"/>
	<input type="checkbox"/>	<input checked="" type="checkbox"/>	<input type="checkbox"/>	<input type="checkbox"/>	<input type="checkbox"/>	<input type="checkbox"/>
	<input type="checkbox"/>	<input checked="" type="checkbox"/>	<input type="checkbox"/>	<input type="checkbox"/>	<input type="checkbox"/>	<input type="checkbox"/>
	<input type="checkbox"/>	<input checked="" type="checkbox"/>	<input type="checkbox"/>	<input type="checkbox"/>	<input type="checkbox"/>	<input type="checkbox"/>
	<input type="checkbox"/>	<input checked="" type="checkbox"/>	<input type="checkbox"/>	<input type="checkbox"/>	<input type="checkbox"/>	<input type="checkbox"/>
	<input type="checkbox"/>	<input checked="" type="checkbox"/>	<input type="checkbox"/>	<input type="checkbox"/>	<input type="checkbox"/>	<input type="checkbox"/>
	<input type="checkbox"/>	<input checked="" type="checkbox"/>	<input type="checkbox"/>	<input type="checkbox"/>	<input type="checkbox"/>	<input type="checkbox"/>
	<input type="checkbox"/>	<input checked="" type="checkbox"/>	<input type="checkbox"/>	<input type="checkbox"/>	<input type="checkbox"/>	<input type="checkbox"/>
	<input type="checkbox"/>	<input checked="" type="checkbox"/>	<input type="checkbox"/>	<input type="checkbox"/>	<input type="checkbox"/>	<input type="checkbox"/>
	<input type="checkbox"/>	<input checked="" type="checkbox"/>	<input type="checkbox"/>	<input type="checkbox"/>	<input type="checkbox"/>	<input type="checkbox"/>
	<input type="checkbox"/>	<input checked="" type="checkbox"/>	<input type="checkbox"/>	<input type="checkbox"/>	<input type="checkbox"/>	<input type="checkbox"/>
	<input type="checkbox"/>	<input checked="" type="checkbox"/>	<input type="checkbox"/>	<input type="checkbox"/>	<input type="checkbox"/>	<input type="checkbox"/>
E14		<input type="checkbox"/>	<input checked="" type="checkbox"/>	<input type="checkbox"/>	<input checked="" type="checkbox"/>	<input type="checkbox"/>
	<input type="checkbox"/>	<input type="checkbox"/>	<input checked="" type="checkbox"/>	<input type="checkbox"/>	<input type="checkbox"/>	<input type="checkbox"/>
	<input type="checkbox"/>	<input type="checkbox"/>	<input checked="" type="checkbox"/>	<input type="checkbox"/>	<input type="checkbox"/>	<input type="checkbox"/>
	<input type="checkbox"/>	<input type="checkbox"/>	<input checked="" type="checkbox"/>	<input type="checkbox"/>	<input type="checkbox"/>	<input type="checkbox"/>
E11		<input type="checkbox"/>	<input type="checkbox"/>	<input checked="" type="checkbox"/>	<input type="checkbox"/>	<input type="checkbox"/>
	<input type="checkbox"/>	<input type="checkbox"/>	<input type="checkbox"/>	<input checked="" type="checkbox"/>	<input type="checkbox"/>	<input type="checkbox"/>
	<input type="checkbox"/>	<input type="checkbox"/>	<input type="checkbox"/>	<input checked="" type="checkbox"/>	<input type="checkbox"/>	<input type="checkbox"/>

Overview Matrix

Lighting









The overview table makes it easier to quickly find and compare lights by their specific features.

The table provides a comprehensive overview of lighting products, including their technical specifications and energy efficiency. Key columns include:

- Lampenform** (Lamp type): T8, T5, LED, etc.
- Abstrahlwinkel** (Beam angle): 30°, 45°, 60°, 90°, 120°, 180°
- Nominale Nutzlichtstrom** (Nominal useful light flux): in lumens
- Nennleistungsaufnahme** (Rated power consumption): in Watts
- Farbtemperatur** (Color temperature): Warmweiß, Neutral, Tageslicht
- Farbwiedergabeindex** (Color rendering index): Ra, Rn, Rf, etc.
- EKK** (Energy efficiency class): A+, A, B, C, D, E
- Art. Nr.** (Article number)
- Katalog Seite** (Catalog page)

LED 230 V	34
LED 12 V	36
Halogen 230 V	38
Halogen 12 V	38
Fluorescent lamps	40











LED 230 V

Socket	Shapes of lamps							Dimmable
	 Globe	 Bulb	 Drops	 Candle	 Reflector	 Base pin	 Tube	
E27 	G120							✓
		✓						-
		✓						✓
		✓						-
		✓						-
		✓						-
		✓						✓
		✓						-
		✓						-
		✓ Filament						-
		✓ All glass						-
		✓						-
		✓						✓
		✓						-
		✓ All glass						-
		✓						-
		✓						-
		✓ Filament						-
		✓						✓
				✓				-
			✓ All glass				-	
					✓ R63		-	
					✓ R63		-	
E14 			✓					-
			✓					✓
			✓					-
			✓					-
			✓					-
			✓					-
			✓					-
			✓ All glass					-
			✓ Filament					-
			✓					-
				✓				✓
				✓				-
				✓				-
				✓				-
				✓ Filament				-
				✓				-
				✓				-
				✓ All glass				-
				✓ Filament				-
				✓				-
			✓				-	
					✓ R50		-	
					✓ R39		-	











Beam angle 	Nominal light output (Lumen)	Nominal power consumption Equivalent incandescent lamp (Watt)	Lighting color			Color reproduction index	EEC	Item no.	Catalogue page
			less than 3300 K	3300 to 5300 K	more than 5300 K				
			warm white	cool white	day light				
150°	1300 lm	16 W (≈ 88 W)	2700 K			> CRI 80	A+	112136	58
140°	1521 lm	16 W (≈ 100 W)	2700 K			> CRI 80	A+	112190	44
240°	1060 lm	12 W (≈ 75 W)	2700 K			> CRI 80	A+	112177	44
240°	1060 lm	12,5 W (≈ 75 W)	2700 K			> CRI 80	A+	112172	45
145°	1060 lm	13,5 W (≈ 75 W)	2700 K			> CRI 80	A+	112188	69
240°	840 lm	9,2 W (≈ 62 W)			6500 K	> CRI 80	A+	112205	51
240°	806 lm	10,5 W (≈ 60 W)	2700 K			> CRI 80	A+	112176	45
240°	806 lm	9,2 W (≈ 60 W)	2700 K			> CRI 90	A+	112198	48
240°	806 lm	9,2 W (≈ 60 W)	2700 K			> CRI 80	A+	112179	70
320°	806 lm	6,2 W (≈ 60 W)	2700 K			> CRI 80	A+	112236	55
300°	630 lm	6 W (≈ 50 W)	2700 K			> CRI 80	A+	112231	53
240°	510 lm	6,3 W (≈ 42 W)			6500 K	> CRI 80	A+	112206	51
240°	470 lm	6,6 W (≈ 40 W)	2700 K			> CRI 80	A+	112175	45
240°	470 lm	5,6 W (≈ 40 W)	2700 K			> CRI 80	A+	112170	46
240°	470 lm	6,5 W (≈ 40 W)	2700 K			> CRI 90	A+	112199	48
270°	470 lm	4,5 W (≈ 40 W)	2700 K			> CRI 80	A+	112230	53
300°	470 lm	6 W (≈ 40 W)	2700 K			> CRI 80	A+	112186	58
240°	470 lm	5,6 W (≈ 40 W)	2700 K			> CRI 80	A+	112180	70
320°	470 lm	4,3 W (≈ 40 W)	2700 K			> CRI 80	A+	112235	55
120°	65 lm	4,5 W Deco		Multicolour		k.A.	k.A.	112213	57
150°	470 lm	5,5 W (≈ 40 W)	2700 K			> CRI 80	A+	112219	58
270°	250 lm	2,5 W (≈ 25 W)	2700 K			> CRI 80	A++	112229	54
110°	600 lm	9,5 W (≈ 47 W)	2700 K			> CRI 80	A+	112226	61
120°	560 lm	8 W (≈ 45 W)	3000 K			> CRI 80	A+	112134	62
140°	520 lm	6 W (≈ 43 W)			6500 K	> CRI 80	A+	112207	52
240°	450 lm	7 W (≈ 40 W)	2700 K			> CRI 80	A+	112173	46
240°	470 lm	6 W (≈ 40 W)	2700 K			> CRI 80	A+	112168	46
140°	470 lm	6,9 W (≈ 40 W)	2700 K			> CRI 90	A+	112201	49
150°	350 lm	4,5 W (≈ 32 W)	2700 K			> CRI 80	A+	112218	59
150°	250 lm	4 W (≈ 25 W)	2700 K			> CRI 80	A+	112217	59
180°	250 lm	4 W (≈ 25 W)	2700 K			> CRI 90	A+	112200	49
270°	250 lm	2,5 W (≈ 25 W)	2700 K			> CRI 80	A++	112228	54
320°	250 lm	2,4 W (≈ 25 W)	2700 K			> CRI 80	A+	112239	56
180°	250 lm	3,8 W (≈ 25 W)	2700 K			> CRI 80	A+	112184	71
260°	450 lm	7 W (≈ 40 W)	2700 K			> CRI 80	A+	112174	47
230°	470 lm	5,9 W (≈ 40 W)	2700 K			> CRI 80	A+	112169	47
240°	470 lm	6,9 W (≈ 40 W)	2700 K			> CRI 90	A+	112203	49
240°	470 lm	5,7 W (≈ 40 W)	2700 K			> CRI 80	A+	112183	71
320°	450 lm	4 W (≈ 40 W)	2700 K			> CRI 80	A+	112238	55
150°	350 lm	4,5 W (≈ 32 W)	2700 K			> CRI 80	A+	112216	59
280°	250 lm	4 W (≈ 25 W)	2700 K			> CRI 90	A+	112202	50
270°	250 lm	2,5 W (≈ 25 W)	2700 K			> CRI 80	A+	112227	54
320°	250 lm	2,4 W (≈ 25 W)	2700 K			> CRI 80	A+	112237	56
150°	250 lm	4 W (≈ 25 W)	2700 K			> CRI 80	A+	112215	60
280°	260 lm	3,8 W (≈ 26 W)	2700 K			> CRI 80	A+	112182	70
110°	430 lm	6 W (≈ 37 W)	2700 K			> CRI 80	A+	112225	62
120°	245 lm	3 W (≈ 25 W)	2700 K			> CRI 80	A+	112132	62





LED 230 V

Socket	Shapes of lamps							Dimmable	
	 Globe	 Bulb	 Drop	 Candle	 Reflector	 Base pin	 Tube		
GU10 					✓ PAR16			✓	
					✓ PAR16			-	
					✓ PAR16			-	
					✓ PAR16			-	
					✓ PAR16			-	
					✓ PAR16			-	
					✓ PAR16			-	
					✓ PAR16			-	
					✓ PAR16			-	
					✓ PAR16			-	
G9 						✓		-	
						✓		-	
						✓		-	
G13 							✓ 150 cm	-	
							✓ 120 cm	-	
							✓ 60 cm	-	















LED 12 V

Socket	Shapes of lamps							Dimmable	
	 Globe	 Bulb	 Drop	 Candle	 Reflector	 Base pin	 Tube		
GU5,3 					✓ MR 16			-	
					✓ MR 16			-	
					✓ MR 16			-	
					✓ MR 16			-	
					✓ MR 16			-	
GU4					✓ MR 11			-	
G4 						✓		-	
						✓		-	
						✓		-	
						✓		-	











Beam angle 	Nominal light output (Lumen)	Nominal power consumption Equivalent incandescent lamp (Watt)	Lighting color			Color reproduction index	EEC	Item no.	Catalogue page
			less than 3300 K	3300 to 5300 K	more than 5300 K				
			warm white	cool white	day light				
36°	470 lm	6,8 W (= 66 W)	3000 K			> CRI 80	A+	112214	60
36°	425 lm	6,5 W (= 60 W)	3000 K			> CRI 80	A+	112191	60
110°	420 lm	6 W (= 60 W)			6500 K	> CRI 80	A+	112208	52
36°	365 lm	5 W (= 55 W)	3000 K			> CRI 80	A+	112192	61
36°	345 lm	6,2 W (= 50 W)	2700 K			> CRI 90	A	112204	50
36°	345 lm	4,4 W (= 50 W)	2700 K			> CRI 80	A+	112233	56
110°	245 lm	3,5 W (= 37 W)			6500 K	> CRI 80	A+	112209	52
110°	240 lm	3 W (= 24 W)	3000 K			> CRI 80	A+	112220	72
36°	235 lm	3,6 W (= 36 W)	2700 K			> CRI 80	A+	112232	57
36°	230 lm	3,8 W (= 35 W)	3000 K			> CRI 80	A+	112193	61
36°	230 lm	3,8 W (= 35 W)	3000 K			> CRI 80	A+	112185	71
110°	200 lm	3,5 W (= 25 W)	3000 K			> CRI 80	A+	112121	72
140°	210 lm	2,5 W (= 22 W)	2700 K			> CRI 80	A++	112129	63
140°	180 lm	2,4 W (= 19 W)	2700 K			> CRI 80	A+	112161	63
147°	90 lm	1,5 W (= 10 W)	2700 K			> CRI 80	A+	112119	63
150°	2500 lm	28 W Ersatz für 58W		4000 K		> CRI 80	A+	112210	68
150°	1800 lm	20 W Ersatz für 36W		4000 K		> CRI 80	A+	112211	68
150°	900 lm	10 W Ersatz für 18W		4000 K		> CRI 80	A+	112212	69

Beam angle 	Nominal light output (Lumen)	Nominal power consumption Equivalent incandescent lamp (Watt)	Lighting color			Color reproduction index	EEC	Item no.	Catalogue page
			less than 3300 K	3300 to 5300 K	more than 5300 K				
			warm white	cool white	day light				
36°	420 lm	6 W (= 39 W)	3000 K			> CRI 80	A+	112194	64
36°	360 lm	5,6 W (= 36 W)	3000 K			> CRI 80	A+	112195	64
80°	275 lm	5,5 W (= 22 W)	2700 K			> CRI 80	A	112078	65
36°	238 lm	3,9 W (= 23 W)	3000 K			> CRI 80	A+	112196	65
110°	210 lm	3 W (= 22 W)	3000 K			> CRI 80	A+	112221	65
36°	160 lm	2 W (= 20 W)	3000 K			> CRI 80	A++	112135	66
135°	180 lm	2,4 W (= 19 W)	2700 K			> CRI 80	A+	112162	66
360°	180 lm	2 W (= 19 W)	2800 K			> CRI 80	A++	112223	66
360°	100 lm	1,3 W (= 11 W)	2800 K			> CRI 80	A++	112222	67
145°	80 lm	1 W (= 10 W)	2700 K			> CRI 80	A++	112120	67

HALOGEN 230 V

Socket	Shapes of lamps							Dimmable	
	 Globe	 Bulb	 Drop	 Candle	 Reflector	 Base pin	 Tube		
E27 		✓						✓	
		✓						✓	
		✓						✓	
		✓						✓	
		✓						✓	
		✓						✓	
E14 			✓					✓	
			✓					✓	
				✓				✓	
					✓			✓	
						✓ R50		✓	
E27 					✓ R50			✓	
					✓ R63			✓	
GU10 					✓ R63			✓	
					✓ PAR16			✓	
					✓ PAR16			✓	
G9 								✓	
								✓	
								✓	
R7s 							✓ 118 mm	✓	
							✓ 118 mm	✓	
							✓ 118 mm	✓	
							✓ 78 mm	✓	
							✓ 78 mm	✓	





HALOGEN 12 V

Socket	Shapes of lamps							Dimmable	
	 Globe	 Bulb	 Drop	 Candle	 Reflector	 Base pin	 Tube		
GU5,3 					✓ MR 16			✓	
					✓ MR 16			✓	
					✓ MR 16			✓	
GU4					✓ MR 11			✓	
					✓ MR 11			✓	
GY6,35 							✓	✓	
							✓	✓	
							✓	✓	
G4 							✓	✓	
							✓	✓	

Beam angle 	Nominal light output (Lumen)	Nominal power consumption Equivalent incandescent lamp (Watt)	Lighting color			Color reproduction index	EEC	Item no.	Catalogue page
			less than 3300 K	3300 to 5300 K	more than 5300 K				
			warm white	cool white	day light				
360°	2135 lm	116 W (= 150 W)	2800 K			CRI 100	D	112406	77
360°	1320 lm	77 W (= 100 W)	2800 K			CRI 100	D	112405	76
360°	915 lm	57 W (= 75 W)	2800 K			CRI 100	D	112404	76
360°	700 lm	46 W (= 60 W)	2700 K			CRI 100	D	112403	76
360°	405 lm	30 W (= 40 W)	2700 K			CRI 100	D	112402	75
360°	235 lm	20 W (= 25 W)	2700 K			CRI 100	D	112401	75
360°	405 lm	30 W (= 40 W)	2700 K			CRI 100	D	112409	78
360°	405 lm	30 W (= 40 W)	2700 K			CRI 100	D	112408	78
360°	235 lm	20 W (= 26 W)	2700 K			CRI 100	D	112407	77
360°	700 lm	46 W (= 60 W)	2700 K			CRI 100	D	112412	80
360°	405 lm	30 W (= 40 W)	2700 K			CRI 100	D	112411	79
360°	235 lm	20 W (= 26 W)	2700 K			CRI 100	D	112410	79
30°	170 lm	30 W (= 40 W)	2700 K			CRI 100	D	112414	81
30°	90 lm	20 W (= 25 W)	2700 K			CRI 100	D	112413	80
30°	300 lm	46 W (= 60 W)	2700 K			CRI 100	D	112416	81
30°	180 lm	30 W (= 40 W)	2700 K			CRI 100	D	112415	81
30°	300 lm	42 W (= 50 W)	2800 K			CRI 100	D	112422	84
30°	200 lm	30 W (= 35 W)	2700 K			CRI 100	D	112421	84
35°	100 lm	20 W (= 20 W)	2700 K			CRI 100	D	112420	83
360°	740 lm	48 W (= 60 W)	2800 K			CRI 100	D	112419	83
360°	460 lm	33 W (= 40 W)	2700 K			CRI 100	D	112418	82
360°	235 lm	20 W (= 25 W)	2700 K			CRI 100	D	112417	82
360°	9000 lm	400 W (= 500 W)	3000 K			CRI 100	C	112427	86
360°	5000 lm	230 W (= 300 W)	2950 K			CRI 100	C	112426	86
360°	3100 lm	160 W (= 200 W)	2900 K			CRI 100	C	112425	86
360°	2250 lm	120 W (= 150 W)	2950 K			CRI 100	C	112424	85
360°	1400 lm	80 W (= 100 W)	2950 K			CRI 100	C	112423	85

Beam angle 	Nominal light output (Lumen)	Nominal power consumption Equivalent incandescent lamp (Watt)	Lighting color			Color reproduction index	EEC	Item no.	Catalogue page
			less than 3300 K	3300 to 5300 K	more than 5300 K				
			warm white	cool white	day light				
24°	680 lm	50 W (= 59 W)	3000 K			CRI 100	B	112437	91
36°	430 lm	35 W (= 43 W)	3000 K			CRI 100	B	112436	91
36°	210 lm	20 W (= 24 W)	3000 K			CRI 100	B	112435	90
36°	430 lm	35 W (= 43 W)	3000 K			CRI 100	B	112434	90
36°	205 lm	20 W (= 25 W)	3000 K			CRI 100	B	112433	89
360°	910 lm	50 W (= 74 W)	3000 K			CRI 100	C	112432	89
360°	600 lm	35 W (= 53 W)	2900 K			CRI 100	C	112431	88
360°	290 lm	20 W (= 31 W)	2800 K			CRI 100	C	112430	88
360°	320 lm	20 W (= 33 W)	2800 K			CRI 100	C	112429	87
360°	140 lm	10 W (= 17 W)	2800 K			CRI 100	C	112428	87

Fluorescent lamps

Socket	Shapes of lamps		Dimmable
	 T5 tube	 T8 tube	
G13 		✓ 150 cm	-
		✓ 120 cm	-
		✓ 60 cm	-
		✓ 150 cm	-
		✓ 120 cm	-
		✓ 60 cm	-
		✓ 90 cm	-
		✓ 60 cm	-
G5 	✓ 115 cm		-
	✓ 145 cm		-
	✓ 115 cm		-
	✓ 55 cm		-
	✓ 85 cm		-

Beam angle 	Nominal light output (Lumen)	Nominal power consumption Equivalent incandescent lamp (Watt)	Lighting color			Color reproduction index	EEC	Item no.	Catalogue page
			less than 3300 K	3300 to 5300 K	more than 5300 K				
			warm white	cool white	day light				
360°	5050 lm	58 W			6500 K	> CRI 80	A	112016	93
360°	3250 lm	36 W			6500 K	> CRI 80	A	112020	94
360°	1300 lm	18 W			6500 K	> CRI 80	A	112019	94
360°	5250 lm	58 W		4000 K		> CRI 80	A	112017	92
360°	3350 lm	36 W		4000 K		> CRI 80	A	112018	92
360°	1350 lm	18 W		4000 K		> CRI 80	A	112015	93
360°	2200 lm	30 W		4000 K		> CRI 80	B	110549	95
360°	1200 lm	18 W		4000 K		> CRI 80	B	110548	95
360°	5000 lm	54 W		4000 K		> CRI 80	A	110593	96
360°	3650 lm	35 W		4000 K		> CRI 80	A	110592	96
360°	2900 lm	28 W		4000 K		> CRI 80	A	110591	97
360°	2000 lm	24 W		4000 K		> CRI 80	A	110590	97
360°	2100 lm	21 W		4000 K		> CRI 80	A	110589	97



Leuchtmittel

LED	Halogen 230 V	Halogen 22 V	Leuchtröhren	Starter
-----	---------------	--------------	--------------	---------



High Line LED-Lampe, 6W, Tropfenform, E14, Tageslicht

Basishöhe	116 mm	Einstrahlwinkel	24°
Basishöhe	116 mm	Einstrahlwinkel	24°
Farbtemperatur	4000 K	Farbwiedergabefähigkeit	90
Lebensdauer	25.000 h	Lebensdauer	25.000 h
Leistungsverbrauch	6 W	Leistungsverbrauch	6 W
Spannung	230 V	Spannung	230 V
Basisspannung	22 V	Basisspannung	22 V
Lebensdauer	25.000 h	Lebensdauer	25.000 h
Leistungsfähigkeit	6 W	Leistungsfähigkeit	6 W
Spannung	230 V	Spannung	230 V
Basisspannung	22 V	Basisspannung	22 V
Lebensdauer	25.000 h	Lebensdauer	25.000 h
Leistungsfähigkeit	6 W	Leistungsfähigkeit	6 W
Spannung	230 V	Spannung	230 V
Basisspannung	22 V	Basisspannung	22 V
Lebensdauer	25.000 h	Lebensdauer	25.000 h
Leistungsfähigkeit	6 W	Leistungsfähigkeit	6 W



High Line LED-Reflektorlampe, 6W, GU24, PAR26, Tageslicht

Basishöhe	116 mm	Einstrahlwinkel	24°
Basishöhe	116 mm	Einstrahlwinkel	24°
Farbtemperatur	4000 K	Farbwiedergabefähigkeit	90
Lebensdauer	25.000 h	Lebensdauer	25.000 h
Leistungsverbrauch	6 W	Leistungsverbrauch	6 W
Spannung	230 V	Spannung	230 V
Basisspannung	22 V	Basisspannung	22 V
Lebensdauer	25.000 h	Lebensdauer	25.000 h
Leistungsfähigkeit	6 W	Leistungsfähigkeit	6 W
Spannung	230 V	Spannung	230 V
Basisspannung	22 V	Basisspannung	22 V
Lebensdauer	25.000 h	Lebensdauer	25.000 h
Leistungsfähigkeit	6 W	Leistungsfähigkeit	6 W
Spannung	230 V	Spannung	230 V
Basisspannung	22 V	Basisspannung	22 V
Lebensdauer	25.000 h	Lebensdauer	25.000 h
Leistungsfähigkeit	6 W	Leistungsfähigkeit	6 W



High Line LED Reflektorlampe, 3,5W, GU10, PAR16

Basishöhe	116 mm	Einstrahlwinkel	24°
Basishöhe	116 mm	Einstrahlwinkel	24°
Farbtemperatur	4000 K	Farbwiedergabefähigkeit	90
Lebensdauer	25.000 h	Lebensdauer	25.000 h
Leistungsverbrauch	3,5 W	Leistungsverbrauch	3,5 W
Spannung	230 V	Spannung	230 V
Basisspannung	22 V	Basisspannung	22 V
Lebensdauer	25.000 h	Lebensdauer	25.000 h
Leistungsfähigkeit	3,5 W	Leistungsfähigkeit	3,5 W
Spannung	230 V	Spannung	230 V
Basisspannung	22 V	Basisspannung	22 V
Lebensdauer	25.000 h	Lebensdauer	25.000 h
Leistungsfähigkeit	3,5 W	Leistungsfähigkeit	3,5 W

1122037	3122008
4 047463 7 260121	4 047463 7 255148

KAVAX

Product range

Leuchtmittel

LED Halogen 230 V Halogen 12 V Leuchtstofflampen Starter

High Line

LED-Lampe, 6,0W, Glühlampenform, Vollglas, E27, Warmweiß

Beleuchtungsleistung	6,0 W
Spannung	230 V
Leuchtdauer	2000 h
Leuchtstofftyp	LED
Leuchtdichte	120 lm/W
Wärmeentwicklung	gering
Umweltfreundlichkeit	hoch
Materialien	glas, aluminium
Abmessungen	Ø 40 mm, H 50 mm
Nettogewicht	10 g
Bruttogewicht	15 g
Verpackungseinheit	10 Stk
Artikelnummer	312232

LED-Lampe, 4,5W, Glühlampenform, Vollglas, E27, Warmweiß

Beleuchtungsleistung	4,5 W
Spannung	230 V
Leuchtdauer	2000 h
Leuchtstofftyp	LED
Leuchtdichte	135 lm/W
Wärmeentwicklung	gering
Umweltfreundlichkeit	hoch
Materialien	glas, aluminium
Abmessungen	Ø 40 mm, H 50 mm
Nettogewicht	10 g
Bruttogewicht	15 g
Verpackungseinheit	10 Stk
Artikelnummer	312230

Halogen-Reflektorlampe R53, 40W, E27, Warmweiß, 2 Stück

Beleuchtungsleistung	40 W
Spannung	230 V
Leuchtdauer	2000 h
Leuchtstofftyp	Halogen
Leuchtdichte	100 lm/W
Wärmeentwicklung	hoch
Umweltfreundlichkeit	niedrig
Materialien	glas, aluminium
Abmessungen	Ø 50 mm, H 60 mm
Nettogewicht	15 g
Bruttogewicht	20 g
Verpackungseinheit	2 Stk
Artikelnummer	312448

Starter

Spannung	230 V
Leuchtdauer	2000 h
Leuchtstofftyp	LED
Leuchtdichte	100 lm/W
Wärmeentwicklung	gering
Umweltfreundlichkeit	hoch
Materialien	glas, aluminium
Abmessungen	Ø 20 mm, H 30 mm
Nettogewicht	5 g
Bruttogewicht	10 g
Verpackungseinheit	10 Stk
Artikelnummer	312449

LED	44
Halogen 230 V	75
Halogen 12 V	87
Fluorescent lamps	92
Starter	98

Lighting

LED	Halogen 230 V	Halogen 12 V	Fluorescent lamps	Starter
-----	---------------	--------------	-------------------	---------

Highline

Warm white

CRI 90

Daylight

Full glas/filament

Classic line

Tubes

Campaign

Low-voltage transformers

- 5-year warranty
- wide angle of radiation: up to 260°
- lifetime ≥ 25000h
- can be partially dimmed
- light colour: warm white



High Line LED Bulb, 16W, bulb shape, E27, warm white

Can be Dimmed	-
Colour Temperature	2700 K
Design	A 60
Nominal Service Life	25000 h
Number of Switching Cycles until Premature Failure (min.)	40000
Operating Position	360 °
Optimal Ambient Temperature	25 °C
Power Consumption of an Equivalent Incandescent Lamp	100 W
Socket	E 27
Diameter	60 mm
Dimensions Differ From Those of a Standardized Bulb	✓
Height	118 mm
Energy Efficiency Class	A+ (Scale from A++ to E, Optimum Value: A++)
Lamp Current	87 mA
Mains Frequency	50 Hz
Nominal Beam Angle	140 °
Nominal Light Output	1521 lm
Nominal Power Consumption	16 W
Operating Voltage	230 V
Start-Up Time Until 60% of Full Light Output Has Been Reached (max.)	1 s
Weighted Energy Consumption	16 kWh/1000h
Bulb Serves as Replacement for Standard Bulbs of This Size	Light Bulb
Suitable for Accent Lighting	No - Beam Angle between 120° and 360° (φuse)

112190

8	BC	
140 x 155		

4 047443 236173



High Line LED Bulb, 12W, bulb shape, E27, dimmable, warm white

Can be Dimmed	✓
Colour Temperature	2700 K
Design	A 60
Nominal Service Life	25000 h
Number of Switching Cycles until Premature Failure (min.)	40000
Operating Position	360 °
Optimal Ambient Temperature	25 °C
Power Consumption of an Equivalent Incandescent Lamp	75 W
Socket	E 27
Diameter	60 mm
Dimensions Differ From Those of a Standardized Bulb	✓
Height	125 mm
Energy Efficiency Class	A+ (Scale from A++ to E, Optimum Value: A++)
Lamp Current	64 mA
Mains Frequency	50 Hz
Nominal Beam Angle	240 °
Nominal Light Output	1060 lm
Nominal Power Consumption	12 W
Operating Voltage	230 V
Start-Up Time Until 60% of Full Light Output Has Been Reached (max.)	1 s
Weighted Energy Consumption	12 kWh/1000h
Bulb Serves as Replacement for Standard Bulbs of This Size	Light Bulb
Suitable for Accent Lighting	No - Beam Angle between 120° and 360° (φuse)

112177

8	BC	
140 x 184		

4 047443 211156

Lighting

LED	Halogen 230 V	Halogen 12 V	Fluorescent lamps	Starter
-----	---------------	--------------	-------------------	---------



High Line LED Bulb, 12.5W, bulb shape, E27, warm white

Can be Dimmed	-
Colour Temperature	2700 K
Design	A 60
Nominal Service Life	25000 h
Number of Switching Cycles until Premature Failure (min.)	40000
Operating Position	360°
Optimal Ambient Temperature	25 °C
Power Consumption of an Equivalent Incandescent Lamp	75 W
Socket	E 27
Diameter	60 mm
Dimensions Differ From Those of a Standardized Bulb	✓
Height	125 mm
Energy Efficiency Class	A+ (Scale from A++ to E, Optimum Value: A++)
Lamp Current	95 mA
Mains Frequency	50 Hz
Nominal Beam Angle	240°
Nominal Light Output	1060 lm
Nominal Power Consumption	12.5 W
Operating Voltage	230 V
Start-Up Time Until 60% of Full Light Output Has Been Reached (max.)	1 s
Weighted Energy Consumption	13 kWh/1000h
Bulb Serves as Replacement for Standard Bulbs of This Size	Light Bulb
Suitable for Accent Lighting	No - Beam Angle between 120° and 360° (φuse)



High Line LED Bulb, 10.5W, bulb shape, E27, dimmable, warm white

Can be Dimmed	✓
Colour Temperature	2700 K
Design	A 60
Nominal Service Life	25000 h
Number of Switching Cycles until Premature Failure (min.)	40000
Operating Position	360°
Optimal Ambient Temperature	25 °C
Power Consumption of an Equivalent Incandescent Lamp	60 W
Socket	E 27
Diameter	60 mm
Dimensions Differ From Those of a Standardized Bulb	✓
Height	120 mm
Energy Efficiency Class	A+ (Scale from A++ to E, Optimum Value: A++)
Lamp Current	57 mA
Mains Frequency	50 Hz
Nominal Beam Angle	240°
Nominal Light Output	806 lm
Nominal Power Consumption	10.5 W
Operating Voltage	230 V
Start-Up Time Until 60% of Full Light Output Has Been Reached (max.)	1 s
Weighted Energy Consumption	11 kWh/1000h
Bulb Serves as Replacement for Standard Bulbs of This Size	Light Bulb
Suitable for Accent Lighting	No - Beam Angle between 120° and 360° (φuse)



High Line LED Bulb, 6.6W, bulb shape, E27, dimmable, warm white

Can be Dimmed	✓
Colour Temperature	2700 K
Design	A 60
Nominal Service Life	25000 h
Number of Switching Cycles until Premature Failure (min.)	40000
Operating Position	360°
Optimal Ambient Temperature	25 °C
Power Consumption of an Equivalent Incandescent Lamp	40 W
Socket	E 27
Diameter	60 mm
Dimensions Differ From Those of a Standardized Bulb	✓
Height	110 mm
Energy Efficiency Class	A+ (Scale from A++ to E, Optimum Value: A++)
Lamp Current	62 mA
Mains Frequency	50 Hz
Nominal Beam Angle	240°
Nominal Light Output	470 lm
Nominal Power Consumption	6.6 W
Operating Voltage	230 V
Start-Up Time Until 60% of Full Light Output Has Been Reached (max.)	1 s
Weighted Energy Consumption	7 kWh/1000h
Bulb Serves as Replacement for Standard Bulbs of This Size	Light Bulb
Suitable for Accent Lighting	No - Beam Angle between 120° and 360° (φuse)

112172

8 BC 142 x 186 4 047443 210869

112176

8 BC 142 x 186 4 047443 211149

112175

8 BC 142 x 185 4 047443 211132

Lighting

LED	Halogen 230 V	Halogen 12 V	Fluorescent lamps	Starter
-----	---------------	--------------	-------------------	---------



High Line LED Bulb, 5,6W, bulb shape, E27, warm white

Can be Dimmed	-
Colour Temperature	2700 K
Design	A 60
Nominal Service Life	25000 h
Number of Switching Cycles until Premature Failure (min.)	40000
Operating Position	360 °
Optimal Ambient Temperature	25 °C
Power Consumption of an Equivalent Incandescent Lamp	40 W
Socket	E 27
Diameter	60 mm
Dimensions Differ From Those of a Standardized Bulb	✓
Height	110 mm
Energy Efficiency Class	A+ (Scale from A++ to E, Optimum Value: A++)
Lamp Current	51 mA
Mains Frequency	50 Hz
Nominal Beam Angle	240 °
Nominal Light Output	470 lm
Nominal Power Consumption	5.6 W
Operating Voltage	230 V
Start-Up Time Until 60% of Full Light Output Has Been Reached (max.)	1 s
Weighted Energy Consumption	6 kWh/1000h
Bulb Serves as Replacement for Standard Bulbs of This Size	Light Bulb
Suitable for Accent Lighting	No - Beam Angle between 120° and 360° (φuse)



High Line LED Bulb, 7W, drop shape, clear, E14, dimmable, warm white

Can be Dimmed	✓
Colour Temperature	2700 K
Design	P45
Nominal Service Life	25000 h
Number of Switching Cycles until Premature Failure (min.)	40000
Operating Position	360 °
Optimal Ambient Temperature	25 °C
Power Consumption of an Equivalent Incandescent Lamp	40 W
Socket	E 14
Diameter	45 mm
Dimensions Differ From Those of a Standardized Bulb	-
Height	89 mm
Energy Efficiency Class	A+ (Scale from A++ to E, Optimum Value: A++)
Lamp Current	240 mA
Mains Frequency	50 Hz
Nominal Beam Angle	240 °
Nominal Light Output	450 lm
Nominal Power Consumption	7 W
Operating Voltage	230 V
Start-Up Time Until 60% of Full Light Output Has Been Reached (max.)	1 s
Weighted Energy Consumption	7 kWh/1000h
Bulb Serves as Replacement for Standard Bulbs of This Size	Drop
Suitable for Accent Lighting	No - Beam Angle between 120° and 360° (φuse)



High Line LED Bulb, 6W, drop shape, E14, warm white

Can be Dimmed	-
Colour Temperature	2700 K
Design	P45
Nominal Service Life	25000 h
Number of Switching Cycles until Premature Failure (min.)	40000
Operating Position	360 °
Optimal Ambient Temperature	25 °C
Power Consumption of an Equivalent Incandescent Lamp	40 W
Socket	E 14
Diameter	45 mm
Dimensions Differ From Those of a Standardized Bulb	✓
Height	89 mm
Energy Efficiency Class	A+ (Scale from A++ to E, Optimum Value: A++)
Lamp Current	55 mA
Mains Frequency	50 Hz
Nominal Beam Angle	240 °
Nominal Light Output	470 lm
Nominal Power Consumption	6 W
Operating Voltage	230 V
Start-Up Time Until 60% of Full Light Output Has Been Reached (max.)	1 s
Weighted Energy Consumption	6 kWh/1000h
Bulb Serves as Replacement for Standard Bulbs of This Size	Drop
Suitable for Accent Lighting	No - Beam Angle between 120° and 360° (φuse)



Lighting

LED	Halogen 230 V	Halogen 12 V	Fluorescent lamps	Starter
-----	---------------	--------------	-------------------	---------



High Line LED Bulb, 7W, candle shape, clear, E14, dimmable, warm white

Can be Dimmed	✓
Colour Temperature	2700 K
Design	C 38
Nominal Service Life	25000 h
Number of Switching Cycles until Premature Failure (min.)	40000
Operating Position	360°
Optimal Ambient Temperature	25 °C
Power Consumption of an Equivalent Incandescent Lamp	40 W
Socket	E 14
Diameter	38 mm
Dimensions Differ From Those of a Standardized Bulb	✓
Height	112 mm
Energy Efficiency Class	A+ (Scale from A++ to E, Optimum Value: A++)
Lamp Current	58 mA
Mains Frequency	50 Hz
Nominal Beam Angle	260°
Nominal Light Output	450 lm
Nominal Power Consumption	7 W
Operating Voltage	230 V
Start-Up Time Until 60% of Full Light Output Has Been Reached (max.)	1 s
Weighted Energy Consumption	7 kWh/1000h
Bulb Serves as Replacement for Standard Bulbs of This Size	Candle
Suitable for Accent Lighting	No - Beam Angle between 120° and 360° (φuse)



High Line LED Bulb, 5,9W, candle shape, E14, warm white

Can be Dimmed	-
Colour Temperature	2700 K
Design	C 38
Nominal Service Life	25000 h
Number of Switching Cycles until Premature Failure (min.)	40000
Operating Position	360°
Optimal Ambient Temperature	25 °C
Power Consumption of an Equivalent Incandescent Lamp	40 W
Socket	E 14
Diameter	38 mm
Dimensions Differ From Those of a Standardized Bulb	✓
Height	110 mm
Energy Efficiency Class	A+ (Scale from A++ to E, Optimum Value: A++)
Lamp Current	51 mA
Mains Frequency	50 Hz
Nominal Beam Angle	230°
Nominal Light Output	470 lm
Nominal Power Consumption	5,9 W
Operating Voltage	230 V
Start-Up Time Until 60% of Full Light Output Has Been Reached (max.)	1 s
Weighted Energy Consumption	6 kWh/1000h
Bulb Serves as Replacement for Standard Bulbs of This Size	Candle
Suitable for Accent Lighting	No - Beam Angle between 120° and 360° (φuse)



Lighting

LED	Halogen 230 V	Halogen 12 V	Fluorescent lamps	Starter
-----	---------------	--------------	-------------------	---------

Highline
Warm white
CRI 90
Daylight
Full glas/filament
Classic line
Tubes
Campaign
Low-voltage transformers
<ul style="list-style-type: none"> - 5-year warranty - wide angle of radiation: up to 280° - lifetime ≥ 25000h - excellent colour reproduction - light colour: warm white



High Line LED Bulb, 9.2W, bulb shape, E27, warm white, CRI90

Can be Dimmed	-
Colour Temperature	2700 K
Design	A 60
Nominal Service Life	25000 h
Number of Switching Cycles until Premature Failure (min.)	40000
Operating Position	360 °
Optimal Ambient Temperature	25 °C
Power Consumption of an Equivalent Incandescent Lamp	60 W
Socket	E 27
Diameter	60 mm
Dimensions Differ From Those of a Standardized Bulb	✓
Height	120 mm
Energy Efficiency Class	A+ (Scale from A++ to E, Optimum Value: A++)
Lamp Current	79 mA
Mains Frequency	50 Hz
Nominal Beam Angle	240 °
Nominal Light Output	806 lm
Nominal Power Consumption	9.2 W
Operating Voltage	230 V
Start-Up Time Until 60% of Full Light Output Has Been Reached (max.)	1 s
Weighted Energy Consumption	10 kWh/1000h
Bulb Serves as Replacement for Standard Bulbs of This Size	Light Bulb
Suitable for Accent Lighting	No - Beam Angle between 120° and 360° (φuse)

112198

8	BC
140 x 185	4 047443 249647



High Line LED Bulb, 6.5W, bulb shape, E27, warm white, CRI90

Can be Dimmed	-
Colour Temperature	2700 K
Design	A 60
Nominal Service Life	25000 h
Number of Switching Cycles until Premature Failure (min.)	40000
Operating Position	360 °
Optimal Ambient Temperature	25 °C
Power Consumption of an Equivalent Incandescent Lamp	40 W
Socket	E 27
Diameter	60 mm
Dimensions Differ From Those of a Standardized Bulb	✓
Height	110 mm
Energy Efficiency Class	A+ (Scale from A++ to E, Optimum Value: A++)
Lamp Current	60 mA
Mains Frequency	50 Hz
Nominal Beam Angle	240 °
Nominal Light Output	470 lm
Nominal Power Consumption	6.5 W
Operating Voltage	230 V
Start-Up Time Until 60% of Full Light Output Has Been Reached (max.)	1 s
Weighted Energy Consumption	7 kWh/1000h
Bulb Serves as Replacement for Standard Bulbs of This Size	Light Bulb
Suitable for Accent Lighting	No - Beam Angle between 120° and 360° (φuse)

112199

8	BC
140 x 185	4 047443 249654

Lighting

LED	Halogen 230 V	Halogen 12 V	Fluorescent lamps	Starter
-----	---------------	--------------	-------------------	---------



High Line LED Bulb, 6.9W, drop shape, E14, warm white, CRI90

Can be Dimmed	-
Colour Temperature	2700 K
Design	P45
Nominal Service Life	25000 h
Number of Switching Cycles until Premature Failure (min.)	40000
Operating Position	360°
Optimal Ambient Temperature	25 °C
Power Consumption of an Equivalent Incandescent Lamp	40 W
Socket	E 14
Diameter	45 mm
Dimensions Differ From Those of a Standardized Bulb	-
Height	89 mm
Energy Efficiency Class	A+ (Scale from A++ to E, Optimum Value: A++)
Lamp Current	61 mA
Mains Frequency	50 Hz
Nominal Beam Angle	140°
Nominal Light Output	470 lm
Nominal Power Consumption	6.9 W
Operating Voltage	230 V
Start-Up Time Until 60% of Full Light Output Has Been Reached (max.)	1 s
Weighted Energy Consumption	7 kWh/1000h
Bulb Serves as Replacement for Standard Bulbs of This Size	Drop
Suitable for Accent Lighting	No - Beam Angle between 120° and 360° (φuse)



High Line LED Bulb, 4W, drop shape, E14, warm white, CRI90

Can be Dimmed	-
Colour Temperature	2700 K
Design	P45
Nominal Service Life	25000 h
Number of Switching Cycles until Premature Failure (min.)	40000
Operating Position	360°
Optimal Ambient Temperature	25 °C
Power Consumption of an Equivalent Incandescent Lamp	25 W
Socket	E 14
Diameter	45 mm
Dimensions Differ From Those of a Standardized Bulb	-
Height	80 mm
Energy Efficiency Class	A+ (Scale from A++ to E, Optimum Value: A++)
Lamp Current	39 mA
Mains Frequency	50 Hz
Nominal Beam Angle	180°
Nominal Light Output	250 lm
Nominal Power Consumption	4 W
Operating Voltage	230 V
Start-Up Time Until 60% of Full Light Output Has Been Reached (max.)	1 s
Weighted Energy Consumption	4 kWh/1000h
Bulb Serves as Replacement for Standard Bulbs of This Size	Drop
Suitable for Accent Lighting	No - Beam Angle between 120° and 360° (φuse)



High Line LED Bulb, 6.9W, candle shape, E14, warm white, CRI90

Can be Dimmed	-
Colour Temperature	2700 K
Design	C 38
Nominal Service Life	25000 h
Number of Switching Cycles until Premature Failure (min.)	40000
Operating Position	360°
Optimal Ambient Temperature	25 °C
Power Consumption of an Equivalent Incandescent Lamp	40 W
Socket	E 14
Diameter	38 mm
Dimensions Differ From Those of a Standardized Bulb	-
Height	112 mm
Energy Efficiency Class	A+ (Scale from A++ to E, Optimum Value: A++)
Lamp Current	61 mA
Mains Frequency	50 Hz
Nominal Beam Angle	240°
Nominal Light Output	470 lm
Nominal Power Consumption	6.9 W
Operating Voltage	230 V
Start-Up Time Until 60% of Full Light Output Has Been Reached (max.)	1 s
Weighted Energy Consumption	7 kWh/1000h
Bulb Serves as Replacement for Standard Bulbs of This Size	Candle
Suitable for Accent Lighting	No - Beam Angle between 120° and 360° (φuse)



Lighting

LED	Halogen 230 V	Halogen 12 V	Fluorescent lamps	Starter
-----	---------------	--------------	-------------------	---------



High Line LED Bulb, 4W, candle shape, E14, warm white, CRI90

Can be Dimmed	-
Colour Temperature	2700 K
Design	C 35
Nominal Service Life	25000 h
Number of Switching Cycles until Premature Failure (min.)	40000
Operating Position	360°
Optimal Ambient Temperature	25 °C
Power Consumption of an Equivalent Incandescent Lamp	25 W
Socket	E 14
Diameter	35 mm
Dimensions Differ From Those of a Standardized Bulb	-
Height	100 mm
Energy Efficiency Class	A+ (Scale from A++ to E, Optimum Value: A++)
Lamp Current	39 mA
Mains Frequency	50 Hz
Nominal Beam Angle	280°
Nominal Light Output	250 lm
Nominal Power Consumption	4 W
Operating Voltage	230 V
Start-Up Time Until 60% of Full Light Output Has Been Reached (max.)	1 s
Weighted Energy Consumption	4 kWh/1000h
Bulb Serves as Replacement for Standard Bulbs of This Size	Candle
Suitable for Accent Lighting	No - Beam Angle between 120° and 360° (φuse)



High Line LED Reflector Bulb, 6.2W, GU10, PAR16, warm white, CRI90

Can be Dimmed	-
Colour Temperature	2700 K
Design	PAR 16
Nominal Service Life	25000 h
Number of Switching Cycles until Premature Failure (min.)	40000
Operating Position	360°
Optimal Ambient Temperature	25 °C
Power Consumption of an Equivalent Incandescent Lamp	50 W
Socket	GU 10
Diameter	50 mm
Dimensions Differ From Those of a Standardized Bulb	-
Height	54 mm
Energy Efficiency Class	A (Scale from A++ to E, Optimum Value: A++)
Lamp Current	58 mA
Mains Frequency	50 Hz
Nominal Beam Angle	36°
Nominal Light Output	345 lm
Nominal Power Consumption	6.2 W
Operating Voltage	230 V
Start-Up Time Until 60% of Full Light Output Has Been Reached (max.)	1 s
Weighted Energy Consumption	7 kWh/1000h
Bulb Serves as Replacement for Standard Bulbs of This Size	PAR 16
Suitable for Accent Lighting	Yes - Beam Angle <90° (φ90°)

		112202	
10	BC	4 047443 249685	
137 x 185			

		112204	
10	BC	4 047443 249708	
142 x 185			

Lighting

LED	Halogen 230 V	Halogen 12 V	Fluorescent lamps	Starter
-----	---------------	--------------	-------------------	---------

Highline

Warm white

CRI 90

Daylight

Full glas/filament

Classic line

Tubes

Campaign

Low-voltage transformers

- 5-year warranty
- wide angle of radiation: up to 240°
- lifetime ≥ 25000h
- light colour: Daylight
- particularly well suited for workplaces, workshops, practices, etc.



High Line LED Bulb, 9.2W, bulb shape, E27, daylight

Can be Dimmed	-
Colour Temperature	6500 K
Design	A 60
Nominal Service Life	25000 h
Number of Switching Cycles until Premature Failure (min.)	40000
Operating Position	360 °
Optimal Ambient Temperature	25 °C
Power Consumption of an Equivalent Incandescent Lamp	62 W
Socket	E 27
Diameter	60 mm
Dimensions Differ From Those of a Standardized Bulb	✓
Height	110 mm
Energy Efficiency Class	A+ (Scale from A++ to E, Optimum Value: A++)
Lamp Current	84 mA
Mains Frequency	50 Hz
Nominal Beam Angle	240 °
Nominal Light Output	840 lm
Nominal Power Consumption	9.2 W
Operating Voltage	230 V
Start-Up Time Until 60% of Full Light Output Has Been Reached (max.)	1 s
Weighted Energy Consumption	10 kWh/1000h
Bulb Serves as Replacement for Standard Bulbs of This Size	Light Bulb
Suitable for Accent Lighting	No - Beam Angle between 120° and 360° (φuse)

112205

8 BC 140 x 185 4 047443 250117



High Line LED Bulb, 6.3W, bulb shape, E27, daylight

Can be Dimmed	-
Colour Temperature	6500 K
Design	A 60
Nominal Service Life	25000 h
Number of Switching Cycles until Premature Failure (min.)	40000
Operating Position	360 °
Optimal Ambient Temperature	25 °C
Power Consumption of an Equivalent Incandescent Lamp	42 W
Socket	E 27
Diameter	60 mm
Dimensions Differ From Those of a Standardized Bulb	✓
Height	110 mm
Energy Efficiency Class	A+ (Scale from A++ to E, Optimum Value: A++)
Lamp Current	57 mA
Mains Frequency	50 Hz
Nominal Beam Angle	240 °
Nominal Light Output	510 lm
Nominal Power Consumption	6.3 W
Operating Voltage	230 V
Start-Up Time Until 60% of Full Light Output Has Been Reached (max.)	1 s
Weighted Energy Consumption	7 kWh/1000h
Bulb Serves as Replacement for Standard Bulbs of This Size	Light Bulb
Suitable for Accent Lighting	No - Beam Angle between 120° and 360° (φuse)

112206

8 BC 140 x 185 4 047443 250124

Lighting

LED	Halogen 230 V	Halogen 12 V	Fluorescent lamps	Starter
-----	---------------	--------------	-------------------	---------



High Line LED Bulb, 6W, drop shape, E14, daylight

Can be Dimmed	-
Colour Temperature	6500 K
Design	Drop
Nominal Service Life	25000 h
Number of Switching Cycles until Premature Failure (min.)	40000
Operating Position	360°
Optimal Ambient Temperature	25 °C
Power Consumption of an Equivalent Incandescent Lamp	42 W
Socket	E 14
Diameter	45 mm
Dimensions Differ From Those of a Standardized Bulb	-
Height	89 mm
Energy Efficiency Class	A+ (Scale from A++ to E, Optimum Value: A++)
Lamp Current	55 mA
Mains Frequency	50 Hz
Nominal Beam Angle	140°
Nominal Light Output	520 lm
Nominal Power Consumption	6 W
Operating Voltage	230 V
Start-Up Time Until 60% of Full Light Output Has Been Reached (max.)	1 s
Weighted Energy Consumption	6 kWh/1000h
Bulb Serves as Replacement for Standard Bulbs of This Size	Drop
Suitable for Accent Lighting	No - Beam Angle between 120° and 360° (φuse)



High Line LED Reflector Bulb, 6W, GU10, PAR16, daylight

Can be Dimmed	-
Colour Temperature	6500 K
Design	PAR 16
Nominal Service Life	20000 h
Number of Switching Cycles until Premature Failure (min.)	40000
Operating Position	360°
Optimal Ambient Temperature	25 °C
Power Consumption of an Equivalent Incandescent Lamp	60 W
Socket	GU 10
Diameter	50 mm
Dimensions Differ From Those of a Standardized Bulb	-
Height	61 mm
Energy Efficiency Class	A+ (Scale from A++ to E, Optimum Value: A++)
Lamp Current	34 mA
Mains Frequency	50 Hz
Nominal Beam Angle	110°
Nominal Light Output	420 lm
Nominal Power Consumption	6 W
Operating Voltage	230 V
Start-Up Time Until 60% of Full Light Output Has Been Reached (max.)	1 s
Weighted Energy Consumption	6 kWh/1000h
Bulb Serves as Replacement for Standard Bulbs of This Size	PAR 16
Suitable for Accent Lighting	No - Beam Angle between 90° and 120° (φ120°)



High Line LED Reflector Bulb, 3,5W, GU10, PAR16, daylight

Can be Dimmed	-
Colour Temperature	6500 K
Design	PAR 16
Nominal Service Life	25000 h
Number of Switching Cycles until Premature Failure (min.)	40000
Operating Position	360°
Optimal Ambient Temperature	25 °C
Power Consumption of an Equivalent Incandescent Lamp	37 W
Socket	GU 10
Diameter	50 mm
Dimensions Differ From Those of a Standardized Bulb	-
Height	56 mm
Energy Efficiency Class	A+ (Scale from A++ to E, Optimum Value: A++)
Lamp Current	30 mA
Mains Frequency	50 Hz
Nominal Beam Angle	110°
Nominal Light Output	245 lm
Nominal Power Consumption	3,5 W
Operating Voltage	230 V
Start-Up Time Until 60% of Full Light Output Has Been Reached (max.)	1 s
Weighted Energy Consumption	4 kWh/1000h
Bulb Serves as Replacement for Standard Bulbs of This Size	PAR 16
Suitable for Accent Lighting	No - Beam Angle between 90° and 120° (φ120°)

112207

10	BC
140 x 184	

4 047443 250131

112208

10	BC
140 x 184	

4 047443 250148

112209

10	BC
140 x 185	

4 047443 249210

Lighting

LED	Halogen 230 V	Halogen 12 V	Fluorescent lamps	Starter
-----	---------------	--------------	-------------------	---------

Highline

Warm white

CRI 90

Daylight

Full glas/filament

Classic line

Tubes

Campaign

Low-voltage transformers

- 5-year warranty
- wide angle of radiation: up to 320°
- classic all-glass lamp body
- indistinguishable to the eye from conventional light bulbs
- light colour: warm white



LED Bulb, 6.0W, bulb shape, full glass, E27, warm white

Can be Dimmed	-
Colour Temperature	2700 K
Design	A 60
Nominal Service Life	25000 h
Number of Switching Cycles until Premature Failure (min.)	15000
Operating Position	360 °
Optimal Ambient Temperature	25 °C
Power Consumption of an Equivalent Incandescent Lamp	50 W
Socket	E 27
Diameter	60 mm
Dimensions Differ From Those of a Standardized Bulb	-
Height	108 mm
Energy Efficiency Class	A++ (Scale from A++ to E, Optimum Value: A++)
Lamp Current	50 mA
Mains Frequency	50 Hz
Nominal Beam Angle	300 °
Nominal Light Output	630 lm
Nominal Power Consumption	6 W
Operating Voltage	230 V
Start-Up Time Until 60% of Full Light Output Has Been Reached (max.)	1 s
Weighted Energy Consumption	6 kWh/1000h
Bulb Serves as Replacement for Standard Bulbs of This Size	Light Bulb
Suitable for Accent Lighting	No - Beam Angle between 120° and 360° (φuse)

112231

10	BC	
141 x 185		

4 047443 277756



LED Bulb, 4.5W, bulb shape, full glass, E27, warm white

Can be Dimmed	-
Colour Temperature	2700 K
Design	A 55
Nominal Service Life	27000 h
Number of Switching Cycles until Premature Failure (min.)	15000
Operating Position	360 °
Optimal Ambient Temperature	25 °C
Power Consumption of an Equivalent Incandescent Lamp	40 W
Socket	E 27
Diameter	55 mm
Dimensions Differ From Those of a Standardized Bulb	-
Height	93 mm
Energy Efficiency Class	A++ (Scale from A++ to E, Optimum Value: A++)
Lamp Current	41 mA
Mains Frequency	50 Hz
Nominal Beam Angle	270 °
Nominal Light Output	470 lm
Nominal Power Consumption	4.5 W
Operating Voltage	230 V
Start-Up Time Until 60% of Full Light Output Has Been Reached (max.)	0.061 s
Weighted Energy Consumption	5 kWh/1000h
Bulb Serves as Replacement for Standard Bulbs of This Size	Light Bulb
Suitable for Accent Lighting	No - Beam Angle between 120° and 360° (φuse)

112230

10	BC	
141 x 183		

4 047443 277749

Lighting

Coffee & Tea

Household goods & Decoration

Small household appliances

Cleaning & Care

Energy & Technology

Accessories for household appliances

Lighting

LED	Halogen 230 V	Halogen 12 V	Fluorescent lamps	Starter
-----	---------------	--------------	-------------------	---------



LED Bulb, 2.5W, drop shape, full glass, E27, warm white

Can be Dimmed	-
Colour Temperature	2700 K
Design	P45
Nominal Service Life	25000 h
Number of Switching Cycles until Premature Failure (min.)	15000
Operating Position	360 °
Optimal Ambient Temperature	25 °C
Power Consumption of an Equivalent Incandescent Lamp	25 W
Socket	E 27
Diameter	45 mm
Dimensions Differ From Those of a Standardized Bulb	-
Height	78 mm
Energy Efficiency Class	A++ (Scale from A++ to E, Optimum Value: A++)
Lamp Current	21 mA
Mains Frequency	50 Hz
Nominal Beam Angle	270 °
Nominal Light Output	250 lm
Nominal Power Consumption	2.5 W
Operating Voltage	230 V
Start-Up Time Until 60% of Full Light Output Has Been Reached (max.)	0.054 s
Weighted Energy Consumption	3 kWh/1000h
Bulb Serves as Replacement for Standard Bulbs of This Size	Drop
Suitable for Accent Lighting	No - Beam Angle between 120° and 360° (φuse)



LED Bulb, 2.5W, drop shape, full glass, E14, warm white

Can be Dimmed	-
Colour Temperature	2700 K
Design	P45
Nominal Service Life	25000 h
Number of Switching Cycles until Premature Failure (min.)	15000
Operating Position	360 °
Optimal Ambient Temperature	25 °C
Power Consumption of an Equivalent Incandescent Lamp	25 W
Socket	E 14
Diameter	45 mm
Dimensions Differ From Those of a Standardized Bulb	-
Height	78 mm
Energy Efficiency Class	A++ (Scale from A++ to E, Optimum Value: A++)
Lamp Current	21 mA
Mains Frequency	50 Hz
Nominal Beam Angle	270 °
Nominal Light Output	250 lm
Nominal Power Consumption	2.5 W
Operating Voltage	230 V
Start-Up Time Until 60% of Full Light Output Has Been Reached (max.)	0.054 s
Weighted Energy Consumption	3 kWh/1000h
Bulb Serves as Replacement for Standard Bulbs of This Size	Drop
Suitable for Accent Lighting	No - Beam Angle between 120° and 360° (φuse)



LED Bulb, 2.5W, candle shape, full glass, E14, warm white

Can be Dimmed	-
Colour Temperature	2700 K
Design	C 35
Nominal Service Life	25000 h
Number of Switching Cycles until Premature Failure (min.)	15000
Operating Position	360 °
Optimal Ambient Temperature	25 °C
Power Consumption of an Equivalent Incandescent Lamp	25 W
Socket	E 14
Diameter	35 mm
Dimensions Differ From Those of a Standardized Bulb	-
Height	97 mm
Energy Efficiency Class	A++ (Scale from A++ to E, Optimum Value: A++)
Lamp Current	21 mA
Mains Frequency	50 Hz
Nominal Beam Angle	270 °
Nominal Light Output	250 lm
Nominal Power Consumption	2.5 W
Operating Voltage	230 V
Start-Up Time Until 60% of Full Light Output Has Been Reached (max.)	0.089 s
Weighted Energy Consumption	3 kWh/1000h
Bulb Serves as Replacement for Standard Bulbs of This Size	Candle
Suitable for Accent Lighting	No - Beam Angle between 120° and 360° (φuse)

112229	
10 BC	4
140 x 180	4 047443 277732

112228	
10 BC	4
141 x 183	4 047443 277725

112227	
10 BC	4
141 x 183	4 047443 277718

Lighting

LED	Halogen 230 V	Halogen 12 V	Fluorescent lamps	Starter
-----	---------------	--------------	-------------------	---------



LED Bulb, 6.2W, bulb shape, filament, E27, warm white

Can be Dimmed	-
Colour Temperature	2700 K
Design	A 60
Nominal Service Life	15000 h
Number of Switching Cycles until Premature Failure (min.)	40000
Operating Position	360°
Optimal Ambient Temperature	25 °C
Power Consumption of an Equivalent Incandescent Lamp	60 W
Socket	E 27
Diameter	60 mm
Dimensions Differ From Those of a Standardized Bulb	-
Height	106 mm
Energy Efficiency Class	A++ (Scale from A++ to E, Optimum Value: A++)
Lamp Current	56 mA
Mains Frequency	50 Hz
Nominal Beam Angle	320°
Nominal Light Output	806 lm
Nominal Power Consumption	6.2 W
Operating Voltage	230 V
Start-Up Time Until 60% of Full Light Output Has Been Reached (max.)	1 s
Weighted Energy Consumption	7 kWh/1000h
Bulb Serves as Replacement for Standard Bulbs of This Size	Light Bulb
Suitable for Accent Lighting	No - Beam Angle between 120° and 360° (φuse)



LED Bulb, 4.3W, bulb shape, filament, E27, warm white

Can be Dimmed	-
Colour Temperature	2700 K
Design	A 60
Nominal Service Life	15000 h
Number of Switching Cycles until Premature Failure (min.)	40000
Operating Position	360°
Optimal Ambient Temperature	25 °C
Power Consumption of an Equivalent Incandescent Lamp	40 W
Socket	E 27
Diameter	60 mm
Dimensions Differ From Those of a Standardized Bulb	-
Height	106 mm
Energy Efficiency Class	A++ (Scale from A++ to E, Optimum Value: A++)
Lamp Current	50 mA
Mains Frequency	50 Hz
Nominal Beam Angle	320°
Nominal Light Output	470 lm
Nominal Power Consumption	4.3 W
Operating Voltage	230 V
Start-Up Time Until 60% of Full Light Output Has Been Reached (max.)	1 s
Weighted Energy Consumption	5 kWh/1000h
Bulb Serves as Replacement for Standard Bulbs of This Size	Light Bulb
Suitable for Accent Lighting	No - Beam Angle between 120° and 360° (φuse)



LED Bulb, 4W, candle shape, filament, E14, warm white

Can be Dimmed	-
Colour Temperature	2700 K
Design	C 35
Nominal Service Life	15000 h
Number of Switching Cycles until Premature Failure (min.)	40000
Operating Position	360°
Optimal Ambient Temperature	25 °C
Power Consumption of an Equivalent Incandescent Lamp	38 W
Socket	E 14
Diameter	35 mm
Dimensions Differ From Those of a Standardized Bulb	-
Height	98 mm
Energy Efficiency Class	A++ (Scale from A++ to E, Optimum Value: A++)
Lamp Current	42 mA
Mains Frequency	50 Hz
Nominal Beam Angle	320°
Nominal Light Output	450 lm
Nominal Power Consumption	4 W
Operating Voltage	230 V
Start-Up Time Until 60% of Full Light Output Has Been Reached (max.)	1 s
Weighted Energy Consumption	4 kWh/1000h
Bulb Serves as Replacement for Standard Bulbs of This Size	Candle
Suitable for Accent Lighting	No - Beam Angle between 120° and 360° (φuse)

112236

8 BC

140 x 180

4 047443 296696

112235

8 BC

140 x 180

4 047443 296689

112238

10 BC

140 x 180

4 047443 296719

Lighting

LED	Halogen 230 V	Halogen 12 V	Fluorescent lamps	Starter
-----	---------------	--------------	-------------------	---------



LED Bulb, 2.4W, candle shape, filament, E14, warm white

Can be Dimmed	-
Colour Temperature	2700 K
Design	C 35
Nominal Service Life	15000 h
Number of Switching Cycles until Premature Failure (min.)	40000
Operating Position	360 °
Optimal Ambient Temperature	25 °C
Power Consumption of an Equivalent Incandescent Lamp	25 W
Socket	E 14
Diameter	35 mm
Dimensions Differ From Those of a Standardized Bulb	-
Height	98 mm
Energy Efficiency Class	A++ (Scale from A++ to E, Optimum Value: A++)
Lamp Current	14 mA
Mains Frequency	50 Hz
Nominal Beam Angle	320 °
Nominal Light Output	250 lm
Nominal Power Consumption	2.4 W
Operating Voltage	230 V
Start-Up Time Until 60% of Full Light Output Has Been Reached (max.)	1 s
Weighted Energy Consumption	3 kWh/1000h
Bulb Serves as Replacement for Standard Bulbs of This Size	Candle
Suitable for Accent Lighting	No - Beam Angle between 120° and 360° (φuse)



LED Bulb, 2.4W, drop shape, filament, E14, warm white

Can be Dimmed	-
Colour Temperature	2700 K
Design	Drop
Nominal Service Life	15000 h
Number of Switching Cycles until Premature Failure (min.)	40000
Operating Position	360 °
Optimal Ambient Temperature	25 °C
Power Consumption of an Equivalent Incandescent Lamp	25 W
Socket	E 14
Diameter	45 mm
Dimensions Differ From Those of a Standardized Bulb	-
Height	78 mm
Energy Efficiency Class	A++ (Scale from A++ to E, Optimum Value: A++)
Lamp Current	14 mA
Mains Frequency	50 Hz
Nominal Beam Angle	320 °
Nominal Light Output	250 lm
Nominal Power Consumption	2.4 W
Operating Voltage	230 V
Start-Up Time Until 60% of Full Light Output Has Been Reached (max.)	1 s
Weighted Energy Consumption	3 kWh/1000h
Bulb Serves as Replacement for Standard Bulbs of This Size	Drop
Suitable for Accent Lighting	No - Beam Angle between 120° and 360° (φuse)



LED Reflector Bulb, 4.4W, GU10, PAR16, warm white

Can be Dimmed	-
Colour Temperature	2700 K
Design	PAR 16
Nominal Service Life	25000 h
Number of Switching Cycles until Premature Failure (min.)	40000
Operating Position	360 °
Optimal Ambient Temperature	25 °C
Power Consumption of an Equivalent Incandescent Lamp	50 W
Socket	GU 10
Diameter	50 mm
Dimensions Differ From Those of a Standardized Bulb	-
Height	54 mm
Energy Efficiency Class	A+ (Scale from A++ to E, Optimum Value: A++)
Lamp Current	45 mA
Mains Frequency	50 Hz
Nominal Beam Angle	36 °
Nominal Light Output	345 lm
Nominal Power Consumption	4.4 W
Operating Voltage	230 V
Start-Up Time Until 60% of Full Light Output Has Been Reached (max.)	1 s
Weighted Energy Consumption	5 kWh/1000h
Bulb Serves as Replacement for Standard Bulbs of This Size	PAR 16
Suitable for Accent Lighting	Yes - Beam Angle <90° (φ90°)



LED	Halogen 230 V	Halogen 12 V	Fluorescent lamps	Starter
-----	---------------	--------------	-------------------	---------



LED Reflector Bulb, 3.6W, GU10, PAR16, warm white

Can be Dimmed	-
Colour Temperature	2700 K
Design	PAR 16
Nominal Service Life	25000 h
Number of Switching Cycles until Premature Failure (min.)	40000
Operating Position	360°
Optimal Ambient Temperature	25 °C
Power Consumption of an Equivalent Incandescent Lamp	35 W
Socket	GU 10
Diameter	50 mm
Dimensions Differ From Those of a Standardized Bulb	✓
Height	54 mm
Energy Efficiency Class	A+ (Scale from A++ to E, Optimum Value: A++)
Lamp Current	37 mA
Mains Frequency	50 Hz
Nominal Beam Angle	36°
Nominal Light Output	235 lm
Nominal Power Consumption	3.6 W
Operating Voltage	230 V
Start-Up Time Until 60% of Full Light Output Has Been Reached (max.)	1 s
Weighted Energy Consumption	4 kWh/1000h
Bulb Serves as Replacement for Standard Bulbs of This Size	PAR 16
Suitable for Accent Lighting	Yes - Beam Angle <90° (φ90°)

		112232	
10	BC		
140 x 180			
4		047443	291523

High Line

Classic Line

High-voltage

Low-voltage

Tubes

Campaign

Low-voltage transformers

- 3-year warranty
- lights in classic shapes for all established applications in the home
- light colour: warm white



LED Bulb, E27, 4,5W, bulb shape, multi-colour with remote control

Can be Dimmed	✓
Colour Temperature	multi-colour
Design	A 60
Nominal Service Life	25000 h
Number of Switching Cycles until Premature Failure (min.)	no specifications
Operating Position	360°
Optimal Ambient Temperature	25 °C
Power Consumption of an Equivalent Incandescent Lamp	no specifications
Socket	E 27
Diameter	60 mm
Dimensions Differ From Those of a Standardized Bulb	-
Height	124 mm
Energy Efficiency Class	no specifications
Lamp Current	70 mA
Mains Frequency	50 Hz
Nominal Beam Angle	120°
Nominal Light Output	65 lm
Nominal Power Consumption	4.5 W
Operating Voltage	230 V
Start-Up Time Until 60% of Full Light Output Has Been Reached (max.)	1 s
Weighted Energy Consumption	5 kWh/1000h
Bulb Serves as Replacement for Standard Bulbs of This Size	no specifications
Suitable for Accent Lighting	-

		112213	
10	BC		
150 x 180			
4		047443	249227

Lighting

LED	Halogen 230 V	Halogen 12 V	Fluorescent lamps	Starter
-----	---------------	--------------	-------------------	---------



LED Bulb, 16W, globe, E27, dimmable, warm white

Can be Dimmed	✓
Colour Temperature	2700 K
Design	G 120
Nominal Service Life	25000 h
Number of Switching Cycles until Premature Failure (min.)	12500
Operating Position	360°
Optimal Ambient Temperature	25 °C
Power Consumption of an Equivalent Incandescent Lamp	88 W
Socket	E 27
Diameter	120 mm
Dimensions Differ From Those of a Standardized Bulb	✓
Height	155 mm
Energy Efficiency Class	A+ (Scale from A++ to E, Optimum Value: A++)
Lamp Current	67 mA
Mains Frequency	50 Hz
Nominal Beam Angle	150°
Nominal Light Output	1300 lm
Nominal Power Consumption	16 W
Operating Voltage	230 V
Start-Up Time Until 60% of Full Light Output Has Been Reached (max.)	0,081 s
Weighted Energy Consumption	16 kWh/1000h
Bulb Serves as Replacement for Standard Bulbs of This Size	G120
Suitable for Accent Lighting	No - Beam Angle between 120° and 360° (φuse)



LED Bulb, 10W, bulb shape, E27, warm white, 5 pieces

Can be Dimmed	-
Colour Temperature	2700 K
Design	A 60
Nominal Service Life	15000 h
Number of Switching Cycles until Premature Failure (min.)	15000
Operating Position	360°
Optimal Ambient Temperature	25 °C
Power Consumption of an Equivalent Incandescent Lamp	60 W
Socket	E 27
Diameter	60 mm
Dimensions Differ From Those of a Standardized Bulb	✓
Height	124 mm
Energy Efficiency Class	A+ (Scale from A++ to E, Optimum Value: A++)
Lamp Current	70 mA
Mains Frequency	50 Hz
Nominal Beam Angle	300°
Nominal Light Output	806 lm
Nominal Power Consumption	10 W
Operating Voltage	230 V
Start-Up Time Until 60% of Full Light Output Has Been Reached (max.)	1 s
Weighted Energy Consumption	10 kWh/1000h
Bulb Serves as Replacement for Standard Bulbs of This Size	Light Bulb
Suitable for Accent Lighting	No - Beam Angle between 120° and 360° (φuse)



LED Bulb, 6W, bulb shape, E27, warm white, 5 pieces

Can be Dimmed	-
Colour Temperature	2700 K
Design	A 60
Nominal Service Life	15000 h
Number of Switching Cycles until Premature Failure (min.)	15000
Operating Position	360°
Optimal Ambient Temperature	25 °C
Power Consumption of an Equivalent Incandescent Lamp	40 W
Socket	E 27
Diameter	60 mm
Dimensions Differ From Those of a Standardized Bulb	✓
Height	110 mm
Energy Efficiency Class	A+ (Scale from A++ to E, Optimum Value: A++)
Lamp Current	50 mA
Mains Frequency	50 Hz
Nominal Beam Angle	300°
Nominal Light Output	470 lm
Nominal Power Consumption	6 W
Operating Voltage	230 V
Start-Up Time Until 60% of Full Light Output Has Been Reached (max.)	1 s
Weighted Energy Consumption	6 kWh/1000h
Bulb Serves as Replacement for Standard Bulbs of This Size	Light Bulb
Suitable for Accent Lighting	No - Beam Angle between 120° and 360° (φuse)

112136	
8	CB
4 047443 295682	

112186	
5	BC
140 x 155 4 047443 290311	

112219	
10	BC
140 x 182 4 047443 253194	

Lighting

LED	Halogen 230 V	Halogen 12 V	Fluorescent lamps	Starter
-----	---------------	--------------	-------------------	---------



LED Bulb, 5,5W, drop shape, E27, warm white

Can be Dimmed	-
Colour Temperature	2700 K
Design	P45
Nominal Service Life	25000 h
Number of Switching Cycles until Premature Failure (min.)	12500
Operating Position	360°
Optimal Ambient Temperature	25 °C
Power Consumption of an Equivalent Incandescent Lamp	40 W
Socket	E 27
Diameter	45 mm
Dimensions Differ From Those of a Standardized Bulb	-
Height	78 mm
Energy Efficiency Class	A+ (Scale from A++ to E, Optimum Value: A++)
Lamp Current	46 mA
Mains Frequency	50 Hz
Nominal Beam Angle	150°
Nominal Light Output	470 lm
Nominal Power Consumption	5.5 W
Operating Voltage	230 V
Start-Up Time Until 60% of Full Light Output Has Been Reached (max.)	1 s
Weighted Energy Consumption	6 kWh/1000h
Bulb Serves as Replacement for Standard Bulbs of This Size	Drop
Suitable for Accent Lighting	No - Beam Angle between 120° and 360° (φuse)



LED Bulb, 4,5W, drop shape, E14, warm white

Can be Dimmed	-
Colour Temperature	2700 K
Design	P45
Nominal Service Life	25000 h
Number of Switching Cycles until Premature Failure (min.)	12500
Operating Position	360°
Optimal Ambient Temperature	25 °C
Power Consumption of an Equivalent Incandescent Lamp	32 W
Socket	E 14
Diameter	45 mm
Dimensions Differ From Those of a Standardized Bulb	-
Height	80 mm
Energy Efficiency Class	A+ (Scale from A++ to E, Optimum Value: A++)
Lamp Current	41 mA
Mains Frequency	50 Hz
Nominal Beam Angle	150°
Nominal Light Output	350 lm
Nominal Power Consumption	4.5 W
Operating Voltage	230 V
Start-Up Time Until 60% of Full Light Output Has Been Reached (max.)	1 s
Weighted Energy Consumption	5 kWh/1000h
Bulb Serves as Replacement for Standard Bulbs of This Size	Drop
Suitable for Accent Lighting	No - Beam Angle between 120° and 360° (φuse)



LED Bulb, 4W, drop shape, E14, warm white

Can be Dimmed	-
Colour Temperature	2700 K
Design	P45
Nominal Service Life	25000 h
Number of Switching Cycles until Premature Failure (min.)	12500
Operating Position	360°
Optimal Ambient Temperature	25 °C
Power Consumption of an Equivalent Incandescent Lamp	25 W
Socket	E 14
Diameter	45 mm
Dimensions Differ From Those of a Standardized Bulb	-
Height	80 mm
Energy Efficiency Class	A+ (Scale from A++ to E, Optimum Value: A++)
Lamp Current	39 mA
Mains Frequency	50 Hz
Nominal Beam Angle	150°
Nominal Light Output	250 lm
Nominal Power Consumption	4 W
Operating Voltage	230 V
Start-Up Time Until 60% of Full Light Output Has Been Reached (max.)	1 s
Weighted Energy Consumption	4 kWh/1000h
Bulb Serves as Replacement for Standard Bulbs of This Size	Drop
Suitable for Accent Lighting	No - Beam Angle between 120° and 360° (φuse)

112218

10 BC

140 x 183

4 047443 253187

112217

10 BC

140 x 182

4 047443 253170

112216

10 BC

140 x 183

4 047443 253163

Lighting

LED	Halogen 230 V	Halogen 12 V	Fluorescent lamps	Starter
-----	---------------	--------------	-------------------	---------



LED Bulb, 4.5W, candle shape, E14, warm white

Can be Dimmed	-
Colour Temperature	2700 K
Design	C37
Nominal Service Life	25000 h
Number of Switching Cycles until Premature Failure (min.)	12500
Operating Position	360°
Optimal Ambient Temperature	25 °C
Power Consumption of an Equivalent Incandescent Lamp	32 W
Socket	E 14
Diameter	37 mm
Dimensions Differ From Those of a Standardized Bulb	-
Height	105 mm
Energy Efficiency Class	A+ (Scale from A++ to E, Optimum Value: A++)
Lamp Current	41 mA
Mains Frequency	50 Hz
Nominal Beam Angle	150°
Nominal Light Output	350 lm
Nominal Power Consumption	4.5 W
Operating Voltage	230 V
Start-Up Time Until 60% of Full Light Output Has Been Reached (max.)	1 s
Weighted Energy Consumption	5 kWh/1000h
Bulb Serves as Replacement for Standard Bulbs of This Size	Candle
Suitable for Accent Lighting	No - Beam Angle between 120° and 360° (φuse)



LED Bulb, 4W, candle shape, E14, warm white

Can be Dimmed	-
Colour Temperature	2700 K
Design	C37
Nominal Service Life	25000 h
Number of Switching Cycles until Premature Failure (min.)	12500
Operating Position	360°
Optimal Ambient Temperature	25 °C
Power Consumption of an Equivalent Incandescent Lamp	25 W
Socket	E 14
Diameter	37 mm
Dimensions Differ From Those of a Standardized Bulb	-
Height	105 mm
Energy Efficiency Class	A+ (Scale from A++ to E, Optimum Value: A++)
Lamp Current	39 mA
Mains Frequency	50 Hz
Nominal Beam Angle	150°
Nominal Light Output	250 lm
Nominal Power Consumption	4 W
Operating Voltage	230 V
Start-Up Time Until 60% of Full Light Output Has Been Reached (max.)	1 s
Weighted Energy Consumption	4 kWh/1000h
Bulb Serves as Replacement for Standard Bulbs of This Size	Candle
Suitable for Accent Lighting	No - Beam Angle between 120° and 360° (φuse)



LED Reflector Bulb, 6.8W, GU10, PAR16, dimmable, warm white

Can be Dimmed	✓
Colour Temperature	3000 K
Design	PAR 16
Nominal Service Life	25000 h
Number of Switching Cycles until Premature Failure (min.)	40000
Operating Position	360°
Optimal Ambient Temperature	25 °C
Power Consumption of an Equivalent Incandescent Lamp	66 W
Socket	GU 10
Diameter	50 mm
Dimensions Differ From Those of a Standardized Bulb	-
Height	57 mm
Energy Efficiency Class	A+ (Scale from A++ to E, Optimum Value: A++)
Lamp Current	54 mA
Mains Frequency	50 Hz
Nominal Beam Angle	36°
Nominal Light Output	470 lm
Nominal Power Consumption	6.8 W
Operating Voltage	230 V
Start-Up Time Until 60% of Full Light Output Has Been Reached (max.)	1 s
Weighted Energy Consumption	7 kWh/1000h
Bulb Serves as Replacement for Standard Bulbs of This Size	PAR 16
Suitable for Accent Lighting	Yes - Beam Angle 90° (φ90°)

		112215	
10	BC		
140 x 182			
		4	047443 253149

		112214	
10	BC		
140 x 185			
		4	047443 249234

		112191	
10	BC		
142 x 185			
		4	047443 236180

Lighting

LED	Halogen 230 V	Halogen 12 V	Fluorescent lamps	Starter
-----	---------------	--------------	-------------------	---------



LED Reflector Bulb, 6.5W, GU10, PAR16, warm white

Can be Dimmed	-
Colour Temperature	3000 K
Design	PAR 16
Nominal Service Life	25000 h
Number of Switching Cycles until Premature Failure (min.)	40000
Operating Position	360 °
Optimal Ambient Temperature	25 °C
Power Consumption of an Equivalent Incandescent Lamp	60 W
Socket	GU 10
Diameter	50 mm
Dimensions Differ From Those of a Standardized Bulb	-
Height	57 mm
Energy Efficiency Class	A+ (Scale from A++ to E, Optimum Value: A++)
Lamp Current	60 mA
Mains Frequency	50 Hz
Nominal Beam Angle	36 °
Nominal Light Output	425 lm
Nominal Power Consumption	6.5 W
Operating Voltage	230 V
Start-Up Time Until 60% of Full Light Output Has Been Reached (max.)	1 s
Weighted Energy Consumption	7 kWh/1000h
Bulb Serves as Replacement for Standard Bulbs of This Size	PAR 16
Suitable for Accent Lighting	Yes - Beam Angle 90° (φ90°)



LED Reflector Bulb, 5W, GU10, PAR16, warm white

Can be Dimmed	-
Colour Temperature	3000 K
Design	PAR 16
Nominal Service Life	25000 h
Number of Switching Cycles until Premature Failure (min.)	12500
Operating Position	360 °
Optimal Ambient Temperature	25 °C
Power Consumption of an Equivalent Incandescent Lamp	55 W
Socket	GU 10
Diameter	50 mm
Dimensions Differ From Those of a Standardized Bulb	-
Height	54 mm
Energy Efficiency Class	A+ (Scale from A++ to E, Optimum Value: A++)
Lamp Current	25 mA
Mains Frequency	50 Hz
Nominal Beam Angle	36 °
Nominal Light Output	385 lm
Nominal Power Consumption	5 W
Operating Voltage	230 V
Start-Up Time Until 60% of Full Light Output Has Been Reached (max.)	1 s
Weighted Energy Consumption	5 kWh/1000h
Bulb Serves as Replacement for Standard Bulbs of This Size	PAR 16
Suitable for Accent Lighting	Yes - Beam Angle 90° (φ90°)



LED Reflector Bulb, 3.8W, GU10, PAR16, warm white

Can be Dimmed	-
Colour Temperature	3000 K
Design	PAR 16
Nominal Service Life	25000 h
Number of Switching Cycles until Premature Failure (min.)	12500
Operating Position	360 °
Optimal Ambient Temperature	25 °C
Power Consumption of an Equivalent Incandescent Lamp	31 W
Socket	GU 10
Diameter	50 mm
Dimensions Differ From Those of a Standardized Bulb	-
Height	54 mm
Energy Efficiency Class	A+ (Scale from A++ to E, Optimum Value: A++)
Lamp Current	17 mA
Mains Frequency	50 Hz
Nominal Beam Angle	36 °
Nominal Light Output	250 lm
Nominal Power Consumption	3.8 W
Operating Voltage	230 V
Start-Up Time Until 60% of Full Light Output Has Been Reached (max.)	1 s
Weighted Energy Consumption	4 kWh/1000h
Bulb Serves as Replacement for Standard Bulbs of This Size	PAR 16
Suitable for Accent Lighting	Yes - Beam Angle 90° (φ90°)

112192

10	BC
142 x 185	

4 047443 236197

112193

10	BC
142 x 185	

4 047443 236203

112226

8	BC
140 x 185	

4 047443 276773

Lighting

LED	Halogen 230 V	Halogen 12 V	Fluorescent lamps	Starter
-----	---------------	--------------	-------------------	---------



LED Bulb, 9.5W, R63 reflector, E27, warm white

Can be Dimmed	-
Colour Temperature	2700 K
Design	R 63
Nominal Service Life	25000 h
Number of Switching Cycles until Premature Failure (min.)	40000
Operating Position	360 °
Optimal Ambient Temperature	25 °C
Power Consumption of an Equivalent Incandescent Lamp	45 W
Socket	E 27
Diameter	63 mm
Dimensions Differ From Those of a Standardized Bulb	-
Height	103 mm
Energy Efficiency Class	A+ (Scale from A++ to E, Optimum Value: A++)
Lamp Current	80 mA
Mains Frequency	50 Hz
Nominal Beam Angle	110 °
Nominal Light Output	600 lm
Nominal Power Consumption	9.5 W
Operating Voltage	230 V
Start-Up Time Until 60% of Full Light Output Has Been Reached (max.)	1 s
Weighted Energy Consumption	10 kWh/1000h
Bulb Serves as Replacement for Standard Bulbs of This Size	R 63
Suitable for Accent Lighting	No - Beam Angle between 90° and 120° (φ120°)



LED Bulb, 8W, R63 reflector, E27, warm white

Can be Dimmed	-
Colour Temperature	3000 K
Design	R 63
Nominal Service Life	30000 h
Number of Switching Cycles until Premature Failure (min.)	15000
Operating Position	360 °
Optimal Ambient Temperature	25 °C
Power Consumption of an Equivalent Incandescent Lamp	45 W
Socket	E 27
Diameter	63 mm
Dimensions Differ From Those of a Standardized Bulb	✓
Height	105 mm
Energy Efficiency Class	A+ (Scale from A++ to E, Optimum Value: A++)
Lamp Current	60 mA
Mains Frequency	50 Hz
Nominal Beam Angle	120 °
Nominal Light Output	560 lm
Nominal Power Consumption	8 W
Operating Voltage	230 V
Start-Up Time Until 60% of Full Light Output Has Been Reached (max.)	1 s
Weighted Energy Consumption	8 kWh/1000h
Bulb Serves as Replacement for Standard Bulbs of This Size	R 63
Suitable for Accent Lighting	No - Beam Angle between 90° and 120° (φ120°)



LED Bulb, 6W, R50 reflector, E14, warm white

Can be Dimmed	-
Colour Temperature	2700 K
Design	R 50
Nominal Service Life	25000 h
Number of Switching Cycles until Premature Failure (min.)	40000
Operating Position	360 °
Optimal Ambient Temperature	25 °C
Power Consumption of an Equivalent Incandescent Lamp	37 W
Socket	E 14
Diameter	50 mm
Dimensions Differ From Those of a Standardized Bulb	-
Height	85 mm
Energy Efficiency Class	A+ (Scale from A++ to E, Optimum Value: A++)
Lamp Current	52 mA
Mains Frequency	50 Hz
Nominal Beam Angle	110 °
Nominal Light Output	430 lm
Nominal Power Consumption	6 W
Operating Voltage	230 V
Start-Up Time Until 60% of Full Light Output Has Been Reached (max.)	1 s
Weighted Energy Consumption	6 kWh/1000h
Bulb Serves as Replacement for Standard Bulbs of This Size	R50
Suitable for Accent Lighting	No - Beam Angle between 90° and 120° (φ120°)

112134	
10	BC
142 x 155	
4	047443 204370

112225	
10	BC
140 x 185	
4	047443 276766

112132	
10	BC
142 x 155	
4	047443 204356

Lighting

LED	Halogen 230 V	Halogen 12 V	Fluorescent lamps	Starter
-----	---------------	--------------	-------------------	---------



LED Bulb, 3W, R39 reflector, E14, warm white

Can be Dimmed	-
Colour Temperature	2700 K
Design	R 39
Nominal Service Life	30000 h
Number of Switching Cycles until Premature Failure (min.)	15000
Operating Position	360°
Optimal Ambient Temperature	25 °C
Power Consumption of an Equivalent Incandescent Lamp	25 W
Socket	E 14
Diameter	39 mm
Dimensions Differ From Those of a Standardized Bulb	✓
Height	68 mm
Energy Efficiency Class	A+ (Scale from A++ to E, Optimum Value: A++)
Lamp Current	34 mA
Mains Frequency	50 Hz
Nominal Beam Angle	120°
Nominal Light Output	245 lm
Nominal Power Consumption	3 W
Operating Voltage	230 V
Start-Up Time Until 60% of Full Light Output Has Been Reached (max.)	1 s
Weighted Energy Consumption	3 kWh/1000h
Bulb Serves as Replacement for Standard Bulbs of This Size	R39
Suitable for Accent Lighting	No - Beam Angle between 90° and 120° (φ120°)



HV LED Capsule, 2.5W, G9, warm white

Can be Dimmed	-
Colour Temperature	2700 K
Design	Base Pin
Nominal Service Life	25000 h
Number of Switching Cycles until Premature Failure (min.)	12500
Operating Position	360°
Optimal Ambient Temperature	25 °C
Power Consumption of an Equivalent Incandescent Lamp	22 W
Socket	G 9
Diameter	28 mm
Dimensions Differ From Those of a Standardized Bulb	✓
Height	45 mm
Energy Efficiency Class	A++ (Scale from A++ to E, Optimum Value: A++)
Lamp Current	27 mA
Mains Frequency	50 Hz
Nominal Beam Angle	140°
Nominal Light Output	210 lm
Nominal Power Consumption	2.5 W
Operating Voltage	230 V
Start-Up Time Until 60% of Full Light Output Has Been Reached (max.)	1 s
Weighted Energy Consumption	3 kWh/1000h
Bulb Serves as Replacement for Standard Bulbs of This Size	no specifications
Suitable for Accent Lighting	No - Beam Angle between 120° and 360° (φuse)



HV LED Capsule, 2.4W, G9, warm white

Can be Dimmed	-
Colour Temperature	2700 K
Design	Base Pin
Nominal Service Life	20000 h
Number of Switching Cycles until Premature Failure (min.)	10000
Operating Position	360°
Optimal Ambient Temperature	25 °C
Power Consumption of an Equivalent Incandescent Lamp	19 W
Socket	G 9
Diameter	18 mm
Dimensions Differ From Those of a Standardized Bulb	✓
Height	54 mm
Energy Efficiency Class	A+ (Scale from A++ to E, Optimum Value: A++)
Lamp Current	22 mA
Mains Frequency	50 Hz
Nominal Beam Angle	140°
Nominal Light Output	180 lm
Nominal Power Consumption	2.4 W
Operating Voltage	230 V
Start-Up Time Until 60% of Full Light Output Has Been Reached (max.)	1 s
Weighted Energy Consumption	3 kWh/1000h
Bulb Serves as Replacement for Standard Bulbs of This Size	no specifications
Suitable for Accent Lighting	No - Beam Angle between 120° and 360° (φuse)

112129

20 BC

92 x 158

4 047443 198747

112161

20 BC

92 x 157

4 047443 210753

112119

20 BC

90 x 156

4 047443 181947

Lighting

LED	Halogen 230 V	Halogen 12 V	Fluorescent lamps	Starter
-----	---------------	--------------	-------------------	---------

High Line

Classic Line

High-voltage

Low-voltage

Tubes

Campaign

Low-voltage transformers

- 3-year warranty
- low-voltage lamps suitable for replacing conventional halogen lamps
- light colour: warm white
- take into account transformer power ratings, or even better, replace with low-voltage transformers (see p.51 - 52)



LED Reflector Bulb, 6W, GU5.3, MR16, warm white

Can be Dimmed	-
Colour Temperature	3000 K
Design	MR 16
Nominal Service Life	25000 h
Number of Switching Cycles until Premature Failure (min.)	40000
Operating Position	360 °
Optimal Ambient Temperature	25 °C
Power Consumption of an Equivalent Incandescent Lamp	39 W
Socket	GU 5.3
Diameter	50 mm
Dimensions Differ From Those of a Standardized Bulb	-
Height	45 mm
Energy Efficiency Class	A+ (Scale from A++ to E, Optimum Value: A++)
Lamp Current	500 mA
Mains Frequency	CD or AC Voltage
Nominal Beam Angle	36 °
Nominal Light Output	420 lm
Nominal Power Consumption	6 W
Operating Voltage	12 V
Start-Up Time Until 60% of Full Light Output Has Been Reached (max.)	1 s
Weighted Energy Consumption	7 kWh/1000h
Bulb Serves as Replacement for Standard Bulbs of This Size	MR 16
Suitable for Accent Lighting	Yes - Beam Angle <90° (φ90°)

112194

10		
142 x 185	4	047443 236210



LED Reflector Bulb, 6W, GU5.3, MR16, warm white

Can be Dimmed	-
Colour Temperature	3000 K
Design	MR 16
Nominal Service Life	25000 h
Number of Switching Cycles until Premature Failure (min.)	40000
Operating Position	360 °
Optimal Ambient Temperature	25 °C
Power Consumption of an Equivalent Incandescent Lamp	39 W
Socket	GU 5.3
Diameter	50 mm
Dimensions Differ From Those of a Standardized Bulb	-
Height	45 mm
Energy Efficiency Class	A+ (Scale from A++ to E, Optimum Value: A++)
Lamp Current	500 mA
Mains Frequency	CD or AC Voltage
Nominal Beam Angle	36 °
Nominal Light Output	420 lm
Nominal Power Consumption	6 W
Operating Voltage	12 V
Start-Up Time Until 60% of Full Light Output Has Been Reached (max.)	1 s
Weighted Energy Consumption	7 kWh/1000h
Bulb Serves as Replacement for Standard Bulbs of This Size	MR 16
Suitable for Accent Lighting	Yes - Beam Angle <90° (φ90°)

112195

10	BC	
140 x 180	4	047443 236227

Lighting

LED	Halogen 230 V	Halogen 12 V	Fluorescent lamps	Starter
-----	---------------	--------------	-------------------	---------



LED Reflector Bulb, 5.6W, GU5.3, MR16, warm white

Can be Dimmed	-
Colour Temperature	3000 K
Design	MR 16
Nominal Service Life	25000 h
Number of Switching Cycles until Premature Failure (min.)	40000
Operating Position	360 °
Optimal Ambient Temperature	25 °C
Power Consumption of an Equivalent Incandescent Lamp	36 W
Socket	GU 5,3
Diameter	50 mm
Dimensions Differ From Those of a Standardized Bulb	-
Height	45 mm
Energy Efficiency Class	A+ (Scale from A++ to E, Optimum Value: A++)
Lamp Current	512 mA
Mains Frequency	CD or AC Voltage
Nominal Beam Angle	36 °
Nominal Light Output	360 lm
Nominal Power Consumption	5.6 W
Operating Voltage	12 V
Start-Up Time Until 60% of Full Light Output Has Been Reached (max.)	1 s
Weighted Energy Consumption	7 kWh/1000h
Bulb Serves as Replacement for Standard Bulbs of This Size	MR16
Suitable for Accent Lighting	Yes - Beam Angle $\lt; 90^\circ$ (<math>\phi 90^\circ<="" math>)<="" td=""></math>\phi>

		112078	
10	BC		
140 x 155		4	047443 142511



LED Lamp, GU 5.3, 5.5 W, MR16, warm white

Can be Dimmed	-
Colour Temperature	2700 K
Design	MR 16
Nominal Service Life	25000 h
Number of Switching Cycles until Premature Failure (min.)	12500
Operating Position	360 °
Optimal Ambient Temperature	25 °C
Power Consumption of an Equivalent Incandescent Lamp	22 W
Socket	GU 5,3
Diameter	50 mm
Dimensions Differ From Those of a Standardized Bulb	-
Height	44 mm
Energy Efficiency Class	A (Scale from A++ to E, Optimum Value: A++)
Lamp Current	440 mA
Mains Frequency	CD or AC Voltage
Nominal Beam Angle	80 °
Nominal Light Output	275 lm
Nominal Power Consumption	5.5 W
Operating Voltage	12 V
Start-Up Time Until 60% of Full Light Output Has Been Reached (max.)	1 s
Weighted Energy Consumption	6 kWh/1000h
Bulb Serves as Replacement for Standard Bulbs of This Size	MR16
Suitable for Accent Lighting	Yes - Beam Angle $\lt; 90^\circ$ (<math>\phi 90^\circ<="" math>)<="" td=""></math>\phi>

		112196	
10	BC		
142 x 186		4	047443 236234



LED Reflector Bulb, 3.9W, GU5.3, MR16, warm white

Can be Dimmed	-
Colour Temperature	3000 K
Design	MR 16
Nominal Service Life	25000 h
Number of Switching Cycles until Premature Failure (min.)	12500
Operating Position	360 °
Optimal Ambient Temperature	25 °C
Power Consumption of an Equivalent Incandescent Lamp	23 W
Socket	GU 5,3
Diameter	50 mm
Dimensions Differ From Those of a Standardized Bulb	-
Height	45 mm
Energy Efficiency Class	A+ (Scale from A++ to E, Optimum Value: A++)
Lamp Current	325 mA
Mains Frequency	AC Voltage
Nominal Beam Angle	36 °
Nominal Light Output	238 lm
Nominal Power Consumption	3.9 W
Operating Voltage	12 V
Start-Up Time Until 60% of Full Light Output Has Been Reached (max.)	1 s
Weighted Energy Consumption	5 kWh/1000h
Bulb Serves as Replacement for Standard Bulbs of This Size	MR16
Suitable for Accent Lighting	Yes - Beam Angle $\lt; 90^\circ$ (<math>\phi 90^\circ<="" math>)<="" td=""></math>\phi>

		112221	
10	BC		
140 x 182		4	047443 253217

Lighting

LED	Halogen 230 V	Halogen 12 V	Fluorescent lamps	Starter
-----	---------------	--------------	-------------------	---------



LED Reflector Bulb, 3W, GU5.3, MR16, warm white

Can be Dimmed	-
Colour Temperature	3000 K
Design	MR 16
Nominal Service Life	25000 h
Number of Switching Cycles until Premature Failure (min.)	12500
Operating Position	360 °
Optimal Ambient Temperature	25 °C
Power Consumption of an Equivalent Incandescent Lamp	22 W
Socket	GU 5,3
Diameter	50 mm
Dimensions Differ From Those of a Standardized Bulb	-
Height	45 mm
Energy Efficiency Class	A+ (Scale from A++ to E, Optimum Value: A++)
Lamp Current	330 mA
Mains Frequency	CD or AC Voltage
Nominal Beam Angle	110 °
Nominal Light Output	210 lm
Nominal Power Consumption	3 W
Operating Voltage	12 V
Start-Up Time Until 60% of Full Light Output Has Been Reached (max.)	1 s
Weighted Energy Consumption	4 kWh/1000h
Bulb Serves as Replacement for Standard Bulbs of This Size	MR16
Suitable for Accent Lighting	No - Beam Angle between 90° and 120° (φ120°)



LV LED Reflector Bulb, 2W, GU4, warm white

Can be Dimmed	-
Colour Temperature	3000 K
Design	MR 11
Nominal Service Life	25000 h
Number of Switching Cycles until Premature Failure (min.)	40000
Operating Position	360 °
Optimal Ambient Temperature	25 °C
Power Consumption of an Equivalent Incandescent Lamp	20 W
Socket	GU 4
Diameter	35 mm
Dimensions Differ From Those of a Standardized Bulb	-
Height	40 mm
Energy Efficiency Class	A++ (Scale from A++ to E, Optimum Value: A++)
Lamp Current	182 mA
Mains Frequency	CD or AC Voltage
Nominal Beam Angle	36 °
Nominal Light Output	160 lm
Nominal Power Consumption	2 W
Operating Voltage	12 V
Start-Up Time Until 60% of Full Light Output Has Been Reached (max.)	1 s
Weighted Energy Consumption	3 kWh/1000h
Bulb Serves as Replacement for Standard Bulbs of This Size	MR11
Suitable for Accent Lighting	No - Beam Angle between 120° and 360° (φuse)



LV LED Capsule, 2.4W, G4, warm white

Can be Dimmed	-
Colour Temperature	2700 K
Design	Base Pin
Nominal Service Life	25000 h
Number of Switching Cycles until Premature Failure (min.)	40000
Operating Position	360 °
Optimal Ambient Temperature	25 °C
Power Consumption of an Equivalent Incandescent Lamp	19 W
Socket	G 4
Diameter	18 mm
Dimensions Differ From Those of a Standardized Bulb	✓
Height	50 mm
Energy Efficiency Class	A+ (Scale from A++ to E, Optimum Value: A++)
Lamp Current	200 mA
Mains Frequency	CD or AC Voltage
Nominal Beam Angle	135 °
Nominal Light Output	180 lm
Nominal Power Consumption	2.4 W
Operating Voltage	12 V
Start-Up Time Until 60% of Full Light Output Has Been Reached (max.)	1 s
Weighted Energy Consumption	3 kWh/1000h
Bulb Serves as Replacement for Standard Bulbs of This Size	no specifications
Suitable for Accent Lighting	No - Beam Angle between 120° and 360° (φuse)

112135	
10 BC	4
90 x 180	4 047443 289841

112162	
20 BC	4
88 x 180	4 047443 210760

112223	
10 BC	4
90 x 156	4 047443 263919

Lighting

LED	Halogen 230 V	Halogen 12 V	Fluorescent lamps	Starter
-----	---------------	--------------	-------------------	---------



LV LED Capsule, 2W, G4, silicone, warm white

Can be Dimmed	-
Colour Temperature	2800 K
Design	Base Pin
Nominal Service Life	30000 h
Number of Switching Cycles until Premature Failure (min.)	20000
Operating Position	360°
Optimal Ambient Temperature	25 °C
Power Consumption of an Equivalent Incandescent Lamp	19 W
Socket	G 4
Diameter	13 mm
Dimensions Differ From Those of a Standardized Bulb	✓
Height	37 mm
Energy Efficiency Class	A++ (Scale from A++ to E, Optimum Value: A++)
Lamp Current	167 mA
Mains Frequency	CD or AC Voltage
Nominal Beam Angle	360°
Nominal Light Output	180 lm
Nominal Power Consumption	2 W
Operating Voltage	12 V
Start-Up Time Until 60% of Full Light Output Has Been Reached (max.)	1 s
Weighted Energy Consumption	3 kWh/1000h
Bulb Serves as Replacement for Standard Bulbs of This Size	no specifications
Suitable for Accent Lighting	No - Beam Angle between 120° and 360° (φuse)



LV LED Capsule, 1.3W, G4, silicone, warm white

Can be Dimmed	-
Colour Temperature	2800 K
Design	Base Pin
Nominal Service Life	30000 h
Number of Switching Cycles until Premature Failure (min.)	20000
Operating Position	360°
Optimal Ambient Temperature	25 °C
Power Consumption of an Equivalent Incandescent Lamp	11 W
Socket	G 4
Diameter	9 mm
Dimensions Differ From Those of a Standardized Bulb	✓
Height	35 mm
Energy Efficiency Class	A++ (Scale from A++ to E, Optimum Value: A++)
Lamp Current	108 mA
Mains Frequency	CD or AC Voltage
Nominal Beam Angle	360°
Nominal Light Output	100 lm
Nominal Power Consumption	1.3 W
Operating Voltage	12 V
Start-Up Time Until 60% of Full Light Output Has Been Reached (max.)	1 s
Weighted Energy Consumption	2 kWh/1000h
Bulb Serves as Replacement for Standard Bulbs of This Size	no specifications
Suitable for Accent Lighting	No - Beam Angle between 120° and 360° (φuse)

		112222	
10	BC		
90 x 156		4	047443 263902

		112120	
20	BC		
90 x 155		4	047443 181954

Lighting

LED	Halogen 230 V	Halogen 12 V	Fluorescent lamps	Starter
-----	---------------	--------------	-------------------	---------

Highline
Classic line
Tubes
Campaign
Low-voltage transformers
<ul style="list-style-type: none"> - perfectly suited for replacing fluorescent tubes that are used in lamp housings with starters and a conventional ballast unit (conventional and low-loss ballasts) - no modifications to the lamp required, but the present starter must be replaced with the included dummy starter - instantaneous, flicker-free full brightness, even in temperatures as low as -20°C



LED Tube, 28W, 150 cm, T8/G13, 4000K, neutral white

Can be Dimmed	-
Colour Temperature	4000 K
Design	T8 ø 26 mm rod-shaped
Nominal Service Life	30000 h
Number of Switching Cycles until Premature Failure (min.)	30000
Operating Position	360 °
Optimal Ambient Temperature	25 °C
Power Consumption of an Equivalent Incandescent Lamp	58 W
Socket	G 13
Diameter	29 mm
Dimensions Differ From Those of a Standardized Bulb	-
Height	1500 mm
Energy Efficiency Class	A+ (Scale from A++ to E, Optimum Value: A++)
Lamp Current	330 mA
Mains Frequency	50 Hz
Nominal Beam Angle	150 °
Nominal Light Output	2500 lm
Nominal Power Consumption	28 W
Operating Voltage	230 V
Start-Up Time Until 60% of Full Light Output Has Been Reached (max.)	1 s
Weighted Energy Consumption	28 kWh/1000h
Bulb Serves as Replacement for Standard Bulbs of This Size	Fluorescent Tube
Suitable for Accent Lighting	No



LED Tube, 20W, 120 cm, T8/G13, 4000K, neutral white

Can be Dimmed	-
Colour Temperature	4000 K
Design	T8 ø 26 mm rod-shaped
Nominal Service Life	30000 h
Number of Switching Cycles until Premature Failure (min.)	30000
Operating Position	360 °
Optimal Ambient Temperature	25 °C
Power Consumption of an Equivalent Incandescent Lamp	36 W
Socket	G 13
Diameter	29 mm
Dimensions Differ From Those of a Standardized Bulb	-
Height	1200 mm
Energy Efficiency Class	A+ (Scale from A++ to E, Optimum Value: A++)
Lamp Current	230 mA
Mains Frequency	50 Hz
Nominal Beam Angle	150 °
Nominal Light Output	1800 lm
Nominal Power Consumption	20 W
Operating Voltage	230 V
Start-Up Time Until 60% of Full Light Output Has Been Reached (max.)	1 s
Weighted Energy Consumption	20 kWh/1000h
Bulb Serves as Replacement for Standard Bulbs of This Size	Fluorescent Tube
Suitable for Accent Lighting	No



Lighting

LED	Halogen 230 V	Halogen 12 V	Fluorescent lamps	Starter
-----	---------------	--------------	-------------------	---------



LED Tube, 10W, 60 cm, T8/G13, 4000K, neutral white

Can be Dimmed	-
Colour Temperature	4000 K
Design	T8 Ø 26 mm rod-shaped
Nominal Service Life	30000 h
Number of Switching Cycles until Premature Failure (min.)	30000
Operating Position	360°
Optimal Ambient Temperature	25 °C
Power Consumption of an Equivalent Incandescent Lamp	18 W
Socket	G 13
Diameter	29 mm
Dimensions Differ From Those of a Standardized Bulb	-
Height	600 mm
Energy Efficiency Class	A+ (Scale from A++ to E, Optimum Value: A++)
Lamp Current	120 mA
Mains Frequency	50 Hz
Nominal Beam Angle	150°
Nominal Light Output	900 lm
Nominal Power Consumption	10 W
Operating Voltage	230 V
Start-Up Time Until 60% of Full Light Output Has Been Reached (max.)	1 s
Weighted Energy Consumption	10 kWh/1000h
Bulb Serves as Replacement for Standard Bulbs of This Size	Fluorescent Tube
Suitable for Accent Lighting	No

112212

6	CB
---	----

4 047443 246929

Highline

Classic line

Tubes

Campaign

Low-voltage transformers

- 2-year warranty
- lifetime ≥ 15000h
- outstanding value for money



LED Bulb, 13.5W, bulb shape, E27, warm white, 5 Stück

Can be Dimmed	-
Colour Temperature	2700 K
Design	A 60
Nominal Service Life	15000 h
Number of Switching Cycles until Premature Failure (min.)	15000
Operating Position	300°
Optimal Ambient Temperature	25 °C
Power Consumption of an Equivalent Incandescent Lamp	75 W
Socket	E 27
Diameter	65 mm
Dimensions Differ From Those of a Standardized Bulb	✓
Height	123 mm
Energy Efficiency Class	A+ (Scale from A++ to E, Optimum Value: A++)
Lamp Current	58 mA
Mains Frequency	50 Hz
Nominal Beam Angle	145°
Nominal Light Output	1060 lm
Nominal Power Consumption	13.5 W
Operating Voltage	230 V
Start-Up Time Until 60% of Full Light Output Has Been Reached (max.)	0,274 s
Weighted Energy Consumption	14 kWh/1000h
Bulb Serves as Replacement for Standard Bulbs of This Size	Light Bulb
Suitable for Accent Lighting	No - Beam Angle between 120° and 360° (φuse)

112188

5	BC
---	----

4 047443 290335

Lighting

Coffee & Tea

Household goods & Decoration

Small household appliances

Cleaning & Care

Energy & Technology

Accessories for household appliances

Lighting

LED	Halogen 230 V	Halogen 12 V	Fluorescent lamps	Starter
-----	---------------	--------------	-------------------	---------



LED Bulb, 9.2W, bulb shape, E27, warm white

Can be Dimmed	-
Colour Temperature	2700 K
Design	A 60
Nominal Service Life	15000 h
Number of Switching Cycles until Premature Failure (min.)	30000
Operating Position	360 °
Optimal Ambient Temperature	25 °C
Power Consumption of an Equivalent Incandescent Lamp	60 W
Socket	E 27
Diameter	60 mm
Dimensions Differ From Those of a Standardized Bulb	✓
Height	110 mm
Energy Efficiency Class	A+ (Scale from A++ to E, Optimum Value: A++)
Lamp Current	88 mA
Mains Frequency	50 Hz
Nominal Beam Angle	240 °
Nominal Light Output	806 lm
Nominal Power Consumption	9.2 W
Operating Voltage	230 V
Start-Up Time Until 60% of Full Light Output Has Been Reached (max.)	1 s
Weighted Energy Consumption	10 kWh/1000h
Bulb Serves as Replacement for Standard Bulbs of This Size	Light Bulb
Suitable for Accent Lighting	No - Beam Angle between 120° and 360° (φuse)



LED Bulb, 5.6W, bulb shape, E27, warm white

Can be Dimmed	-
Colour Temperature	2700 K
Design	A 60
Nominal Service Life	15000 h
Number of Switching Cycles until Premature Failure (min.)	30000
Operating Position	360 °
Optimal Ambient Temperature	25 °C
Power Consumption of an Equivalent Incandescent Lamp	40 W
Socket	E 27
Diameter	60 mm
Dimensions Differ From Those of a Standardized Bulb	-
Height	110 mm
Energy Efficiency Class	A+ (Scale from A++ to E, Optimum Value: A++)
Lamp Current	50 mA
Mains Frequency	50 Hz
Nominal Beam Angle	240 °
Nominal Light Output	470 lm
Nominal Power Consumption	5.6 W
Operating Voltage	230 V
Start-Up Time Until 60% of Full Light Output Has Been Reached (max.)	0,30 s
Weighted Energy Consumption	6 kWh/1000h
Bulb Serves as Replacement for Standard Bulbs of This Size	Light Bulb
Suitable for Accent Lighting	No - Beam Angle between 120° and 360° (φuse)



LED Bulb, 3.8W, candle bulb shape, E14, warm white

Can be Dimmed	-
Colour Temperature	2700 K
Design	Candle
Nominal Service Life	15000 h
Number of Switching Cycles until Premature Failure (min.)	30000
Operating Position	360 °
Optimal Ambient Temperature	25 °C
Power Consumption of an Equivalent Incandescent Lamp	26 W
Socket	E 14
Diameter	35 mm
Dimensions Differ From Those of a Standardized Bulb	-
Height	100 mm
Energy Efficiency Class	A+ (Scale from A++ to E, Optimum Value: A++)
Lamp Current	38 mA
Mains Frequency	50 Hz
Nominal Beam Angle	280 °
Nominal Light Output	260 lm
Nominal Power Consumption	3.8 W
Operating Voltage	230 V
Start-Up Time Until 60% of Full Light Output Has Been Reached (max.)	1 s
Weighted Energy Consumption	4 kWh/1000h
Bulb Serves as Replacement for Standard Bulbs of This Size	Candle
Suitable for Accent Lighting	No - Beam Angle between 120° and 360° (φuse)

		112179
5	BC	
140 x 155		
4		047443 235213

		112180
5	BC	
140 x 155		
4		047443 235220

		112182
7	BC	
90 x 155		
4		047443 235244

Lighting

LED	Halogen 230 V	Halogen 12 V	Fluorescent lamps	Starter
-----	---------------	--------------	-------------------	---------



LED Bulb, 5.7W, candle bulb shape, E14, warm white

Can be Dimmed	-
Colour Temperature	2700 K
Design	C 38
Nominal Service Life	15000 h
Number of Switching Cycles until Premature Failure (min.)	30000
Operating Position	360°
Optimal Ambient Temperature	25 °C
Power Consumption of an Equivalent Incandescent Lamp	40 W
Socket	E 14
Diameter	38 mm
Dimensions Differ From Those of a Standardized Bulb	-
Height	112 mm
Energy Efficiency Class	A+ (Scale from A++ to E, Optimum Value: A++)
Lamp Current	54 mA
Mains Frequency	50 Hz
Nominal Beam Angle	240°
Nominal Light Output	470 lm
Nominal Power Consumption	5.7 W
Operating Voltage	230 V
Start-Up Time Until 60% of Full Light Output Has Been Reached (max.)	1 s
Weighted Energy Consumption	6 kWh/1000h
Bulb Serves as Replacement for Standard Bulbs of This Size	Candle
Suitable for Accent Lighting	No - Beam Angle between 120° and 360° (φuse)



LED Bulb, 3.8W, mini globe, E14, warm white

Can be Dimmed	-
Colour Temperature	2700 K
Design	P45
Nominal Service Life	15000 h
Number of Switching Cycles until Premature Failure (min.)	30000
Operating Position	360°
Optimal Ambient Temperature	25 °C
Power Consumption of an Equivalent Incandescent Lamp	26 W
Socket	E 14
Diameter	45 mm
Dimensions Differ From Those of a Standardized Bulb	-
Height	80 mm
Energy Efficiency Class	A+ (Scale from A++ to E, Optimum Value: A++)
Lamp Current	42 mA
Mains Frequency	50 Hz
Nominal Beam Angle	180°
Nominal Light Output	250 lm
Nominal Power Consumption	3.8 W
Operating Voltage	230 V
Start-Up Time Until 60% of Full Light Output Has Been Reached (max.)	1 s
Weighted Energy Consumption	4 kWh/1000h
Bulb Serves as Replacement for Standard Bulbs of This Size	Mini Globe
Suitable for Accent Lighting	No - Beam Angle between 120° and 360° (φuse)



LED Reflector Bulb, 3.8W, GU10, warm white

Can be Dimmed	-
Colour Temperature	3000 K
Design	PAR 16
Nominal Service Life	15000 h
Number of Switching Cycles until Premature Failure (min.)	30000
Operating Position	360°
Optimal Ambient Temperature	25 °C
Power Consumption of an Equivalent Incandescent Lamp	35 W
Socket	GU 10
Diameter	50 mm
Dimensions Differ From Those of a Standardized Bulb	-
Height	54 mm
Energy Efficiency Class	A+ (Scale from A++ to E, Optimum Value: A++)
Lamp Current	34 mA
Mains Frequency	50 Hz
Nominal Beam Angle	36°
Nominal Light Output	230 lm
Nominal Power Consumption	3.8 W
Operating Voltage	230 V
Start-Up Time Until 60% of Full Light Output Has Been Reached (max.)	1 s
Weighted Energy Consumption	4 kWh/1000h
Bulb Serves as Replacement for Standard Bulbs of This Size	PAR 16
Suitable for Accent Lighting	Yes - Beam Angle between 90° (φ90°)



Lighting

LED

Halogen 230 V

Halogen 12 V

Fluorescent lamps

Starter



LED Reflector Bulb, 3W, GU10, PAR16, warm white

Can be Dimmed	-
Colour Temperature	3000 K
Design	PAR 16
Nominal Service Life	25000 h
Number of Switching Cycles until Premature Failure (min.)	12500
Operating Position	360°
Optimal Ambient Temperature	25 °C
Power Consumption of an Equivalent Incandescent Lamp	24 W
Socket	GU 10
Diameter	50 mm
Dimensions Differ From Those of a Standardized Bulb	-
Height	55 mm
Energy Efficiency Class	A+ (Scale from A++ to E, Optimum Value: A++)
Lamp Current	30 mA
Mains Frequency	50 Hz
Nominal Beam Angle	110°
Nominal Light Output	240 lm
Nominal Power Consumption	3 W
Operating Voltage	230 V
Start-Up Time Until 60% of Full Light Output Has Been Reached (max.)	1 s
Weighted Energy Consumption	3 kWh/1000h
Bulb Serves as Replacement for Standard Bulbs of This Size	PAR 16
Suitable for Accent Lighting	No - Beam Angle between 90° and 120° (φ120°)



LED Bulb, GU10, 3.5 W, reflector, warm white

Can be Dimmed	-
Colour Temperature	3000 K
Design	PAR 16
Nominal Service Life	25000 h
Number of Switching Cycles until Premature Failure (min.)	12500
Operating Position	360°
Optimal Ambient Temperature	25 °C
Power Consumption of an Equivalent Incandescent Lamp	25 W
Socket	GU 10
Diameter	50 mm
Dimensions Differ From Those of a Standardized Bulb	-
Height	58 mm
Energy Efficiency Class	A+ (Scale from A++ to E, Optimum Value: A++)
Lamp Current	28 mA
Mains Frequency	50 Hz
Nominal Beam Angle	110°
Nominal Light Output	200 lm
Nominal Power Consumption	3.5 W
Operating Voltage	230 V
Start-Up Time Until 60% of Full Light Output Has Been Reached (max.)	1 s
Weighted Energy Consumption	4 kWh/1000h
Bulb Serves as Replacement for Standard Bulbs of This Size	PAR 16
Suitable for Accent Lighting	No - Beam Angle between 90° and 120° (φ120°)

		112220	
10	BC		
140 x 180			
		4 047443 253200	

		112121	
10	BC		
143 x 155			
		4 047443 182586	

Highline

Classic line

Tubes

Campaign

Low-voltage transformers

- includes a powerful transformer specifically designed for low-voltage LED lights
- quality LED transformer in a slim low-heat housing certified for installation in furniture
- transformer provides a constant output voltage of DC 12V and evens out voltage peaks and irregularities
- cooler operation is easier on the electronics in the LED lamps
- 0.75-mm² screw fastenings and reduced tension on connection cables
- fixing tabs on the housing for secure installation



15W LED Driver for Low-Voltage LED Lamps

Maximum Load	1250 mA
Output Voltage	12V
Colour	White



20W LED Driver for Low-Voltage LED Lamps

Maximum Load	1666 mA
Output Voltage	12V
Colour	White

		112023	
10	CB		
		4 047443 255235	

		112024	
10	CB		
		4 047443 255266	



30W LED Driver for Low-Voltage LED Lamps

Maximum Load	2500 mA
Output Voltage	12V
Colour	White

		112025	
10	CB		
		4	047443 255273

Lighting

Light bulb shape

Drop shape

Candle shape

Reflector lamps

G 9 lamps

GU 10 lamps

R 7S lamps

- can easily replace conventional incandescent light bulbs
- the same pleasant light quality as an incandescent bulb
- instantaneous full (100%) brightness when switched on—no warm-up time
- can be dimmed



Halogen Bulb, 20W, E27, warm white, 2 pieces

Angle of Radiation	360 °
Can be Dimmed	✓
Colour Temperature	2700 K
Design	A 55
Nominal Service Life	2000 h
Number of Switching Cycles until Premature Failure (min.)	50000
Operating Position	360 °
Optimal Ambient Temperature	25 °C
Power Consumption of an Equivalent Incandescent Lamp	25 W
Diameter	56 mm
Height	97 mm
Energy Efficiency Class	D (Scale from A++ to E, Optimum Value: A++)
Nominal Light Output	235 lm
Mains Frequency	50 Hz
Nominal Power Consumption	20 W
Operating Voltage	230 V
Start-Up Time Until 60% of Full Light Output Has Been Reached (max.)	1 s
Weighted Energy Consumption	20 kWh/1000h
Light Colour	Warm White



Halogen Bulb, 30W, E27, warm white, 2 pieces

Angle of Radiation	360 °
Can be Dimmed	✓
Colour Temperature	2700 K
Design	A 55
Nominal Service Life	2000 h
Number of Switching Cycles until Premature Failure (min.)	50000
Operating Position	360 °
Optimal Ambient Temperature	25 °C
Power Consumption of an Equivalent Incandescent Lamp	40 W
Diameter	56 mm
Height	97 mm
Energy Efficiency Class	D (Scale from A++ to E, Optimum Value: A++)
Nominal Light Output	405 lm
Mains Frequency	50 Hz
Nominal Power Consumption	30 W
Operating Voltage	230 V
Start-Up Time Until 60% of Full Light Output Has Been Reached (max.)	1 s
Weighted Energy Consumption	30 kWh/1000h
Light Colour	Warm White



Lighting

LED	Halogen 230 V	Halogen 12 V	Fluorescent lamps	Starter
-----	---------------	--------------	-------------------	---------



Halogen Bulb, 46W, E27, warm white, 2 pieces

Angle of Radiation	360 °
Can be Dimmed	✓
Colour Temperature	2700 K
Design	A 55
Nominal Service Life	2000 h
Number of Switching Cycles until Premature Failure (min.)	50000
Operating Position	360 °
Optimal Ambient Temperature	25 °C
Power Consumption of an Equivalent Incandescent Lamp	60 W
Diameter	56 mm
Height	97 mm
Energy Efficiency Class	D (Scale from A++ to E, Optimum Value: A++)
Nominal Light Output	700 lm
Mains Frequency	50 Hz
Nominal Power Consumption	46 W
Operating Voltage	230 V
Start-Up Time Until 60% of Full Light Output Has Been Reached (max.)	1 s
Weighted Energy Consumption	46 kWh/1000h
Light Colour	Warm White



Halogen Bulb, 57W, E27, warm white, 2 pieces

Angle of Radiation	360 °
Can be Dimmed	✓
Colour Temperature	2800 K
Design	A 55
Nominal Service Life	2000 h
Number of Switching Cycles until Premature Failure (min.)	50000
Operating Position	360 °
Optimal Ambient Temperature	25 °C
Power Consumption of an Equivalent Incandescent Lamp	75 W
Diameter	56 mm
Height	97 mm
Energy Efficiency Class	D (Scale from A++ to E, Optimum Value: A++)
Nominal Light Output	915 lm
Mains Frequency	50 Hz
Nominal Power Consumption	57 W
Operating Voltage	230 V
Start-Up Time Until 60% of Full Light Output Has Been Reached (max.)	1 s
Weighted Energy Consumption	57 kWh/1000h
Light Colour	Warm White



Halogen Bulb, 77W, E27, warm white, 2 pieces

Angle of Radiation	360 °
Can be Dimmed	✓
Colour Temperature	2800 K
Design	A 55
Nominal Service Life	2000 h
Number of Switching Cycles until Premature Failure (min.)	50000
Operating Position	360 °
Optimal Ambient Temperature	25 °C
Power Consumption of an Equivalent Incandescent Lamp	100 W
Diameter	56 mm
Height	97 mm
Energy Efficiency Class	D (Scale from A++ to E, Optimum Value: A++)
Nominal Light Output	1320 lm
Mains Frequency	50 Hz
Nominal Power Consumption	77 W
Operating Voltage	230 V
Start-Up Time Until 60% of Full Light Output Has Been Reached (max.)	1 s
Weighted Energy Consumption	77 kWh/1000h
Light Colour	Warm White



Lighting



Halogen Bulb, 116W, E27, warm white, 1 piece

Angle of Radiation	360°
Can be Dimmed	✓
Colour Temperature	2800 K
Design	A 55
Nominal Service Life	2000 h
Number of Switching Cycles until Premature Failure (min.)	50000
Operating Position	360°
Optimal Ambient Temperature	25 °C
Power Consumption of an Equivalent Incandescent Lamp	150 W
Diameter	56 mm
Height	97 mm
Energy Efficiency Class	D (Scale from A++ to E, Optimum Value: A++)
Nominal Light Output	2135 lm
Mains Frequency	50 Hz
Nominal Power Consumption	116 W
Operating Voltage	230 V
Start-Up Time Until 60% of Full Light Output Has Been Reached (max.)	0 s
Weighted Energy Consumption	116 kWh/1000h
Light Colour	Warm White



Light bulb shape

Drop shape

Candle shape

Reflector lamps

G 9 lamps

GU 10 lamps

R 7S lamps

- can easily replace conventional incandescent round bulbs
- the same pleasant light quality as an incandescent bulb
- instantaneous full (100%) brightness when switched on—no warm-up time
- can be dimmed



Halogen Bulb, drop shaped, 20W, E14, warm white, 1 piece

Angle of Radiation	360°
Can be Dimmed	✓
Colour Temperature	2700 K
Design	Drop
Nominal Service Life	2000 h
Number of Switching Cycles until Premature Failure (min.)	50000
Operating Position	360°
Optimal Ambient Temperature	25 °C
Power Consumption of an Equivalent Incandescent Lamp	26 W
Diameter	46 mm
Height	77 mm
Energy Efficiency Class	D (Scale from A++ to E, Optimum Value: A++)
Nominal Light Output	235 lm
Mains Frequency	50 Hz
Nominal Power Consumption	20 W
Operating Voltage	230 V
Start-Up Time Until 60% of Full Light Output Has Been Reached (max.)	1 s
Weighted Energy Consumption	20 kWh/1000h
Light Colour	Warm White



Lighting



Halogen Bulb, drop shaped, 30W, E14, warm white, 1 piece

Angle of Radiation	360 °
Can be Dimmed	✓
Colour Temperature	2700 K
Design	Drop
Nominal Service Life	2000 h
Number of Switching Cycles until Premature Failure (min.)	50000
Operating Position	360 °
Optimal Ambient Temperature	25 °C
Power Consumption of an Equivalent Incandescent Lamp	40 W
Diameter	46 mm
Height	77 mm
Energy Efficiency Class	D (Scale from A++ to E, Optimum Value: A++)
Nominal Light Output	405 lm
Mains Frequency	50 Hz
Nominal Power Consumption	30 W
Operating Voltage	230 V
Start-Up Time Until 60% of Full Light Output Has Been Reached (max.)	1 s
Weighted Energy Consumption	30 kWh/1000h
Light Colour	Warm White



Halogen Bulb, drop shaped, 30W, E27, warm white, 1 piece

Angle of Radiation	360 °
Can be Dimmed	✓
Colour Temperature	2700 K
Design	Drop
Nominal Service Life	2000 h
Number of Switching Cycles until Premature Failure (min.)	50000
Operating Position	360 °
Optimal Ambient Temperature	25 °C
Power Consumption of an Equivalent Incandescent Lamp	40 W
Diameter	46 mm
Height	74 mm
Energy Efficiency Class	D (Scale from A++ to E, Optimum Value: A++)
Nominal Light Output	405 lm
Mains Frequency	50 Hz
Nominal Power Consumption	30 W
Operating Voltage	230 V
Start-Up Time Until 60% of Full Light Output Has Been Reached (max.)	0 s
Weighted Energy Consumption	30 kWh/1000h
Light Colour	Warm White

		112408
20	CB	
4	047443	287236

		112409
20	CB	
4	047443	291264

Lighting

Light bulb shape

Drop shape

Candle shape

Reflector lamps

G 9 lamps

GU 10 lamps

R 7S lamps

- can easily replace conventional incandescent candle light bulbs
- the same pleasant light quality as an incandescent bulb
- instantaneous full (100%) brightness when switched on—no warm-up time
- can be dimmed



Halogen Bulb, candle shaped, 20W, E14, warm white, 2 pieces

Angle of Radiation	360 °
Can be Dimmed	✓
Colour Temperature	2700 K
Design	Candle
Nominal Service Life	2000 h
Number of Switching Cycles until Premature Failure (min.)	50000
Operating Position	360 °
Optimal Ambient Temperature	25 °C
Power Consumption of an Equivalent Incandescent Lamp	26 W
Diameter	36 mm
Height	104 mm
Energy Efficiency Class	D (Scale from A++ to E, Optimum Value: A++)
Nominal Light Output	235 lm
Mains Frequency	50 Hz
Nominal Power Consumption	20 W
Operating Voltage	230 V
Start-Up Time Until 60% of Full Light Output Has Been Reached (max.)	1 s
Weighted Energy Consumption	20 kWh/1000h
Light Colour	Warm White

112410

20 CB

4 047443 287243



Halogen Bulb, candle shaped, 30W, E14, warm white, 2 pieces

Angle of Radiation	360 °
Can be Dimmed	✓
Colour Temperature	2700 K
Design	Candle
Nominal Service Life	2000 h
Number of Switching Cycles until Premature Failure (min.)	50000
Operating Position	360 °
Optimal Ambient Temperature	25 °C
Power Consumption of an Equivalent Incandescent Lamp	40 W
Diameter	36 mm
Height	104 mm
Energy Efficiency Class	D (Scale from A++ to E, Optimum Value: A++)
Nominal Light Output	405 lm
Mains Frequency	50 Hz
Nominal Power Consumption	30 W
Operating Voltage	230 V
Start-Up Time Until 60% of Full Light Output Has Been Reached (max.)	1 s
Weighted Energy Consumption	30 kWh/1000h
Light Colour	Warm White

112411

20 CB

4 047443 287250

Lighting

LED	Halogen 230 V	Halogen 12 V	Fluorescent lamps	Starter
-----	---------------	--------------	-------------------	---------



Halogen Bulb, candle shaped, 46W, E14, warm white, 2 pieces

Angle of Radiation	360°
Can be Dimmed	✓
Colour Temperature	2700 K
Design	Candle
Nominal Service Life	2000 h
Number of Switching Cycles until Premature Failure (min.)	50000
Operating Position	360°
Optimal Ambient Temperature	25 °C
Power Consumption of an Equivalent Incandescent Lamp	60 W
Diameter	36 mm
Height	104 mm
Energy Efficiency Class	D (Scale from A++ to E, Optimum Value: A++)
Nominal Light Output	700 lm
Mains Frequency	50 Hz
Nominal Power Consumption	46 W
Operating Voltage	230 V
Start-Up Time Until 60% of Full Light Output Has Been Reached (max.)	1 s
Weighted Energy Consumption	46 kWh/1000h
Light Colour	Warm White

Light bulb shape

Drop shape

Candle shape

Reflector lamps

G 9 lamps

GU 10 lamps

R 7S lamps

- shape and quality of light are identical to those of standard incandescent reflector bulbs

- instantaneous full (100%) brightness when switched on—no warm-up time

- can be dimmed



Halogen Reflector Bulb R50, 20W, E14, warm white, 1 piece

Can be Dimmed	✓
Colour Temperature	2700 K
Design	R 50
Nominal Service Life	2000 h
Number of Switching Cycles until Premature Failure (min.)	50000
Operating Position	360°
Optimal Ambient Temperature	25 °C
Power Consumption of an Equivalent Incandescent Lamp	25 W
Socket	E 14
Diameter	50 mm
Dimensions Differ From Those of a Standardized Bulb	-
Height	86,5 mm
Energy Efficiency Class	D (Scale from A++ to E, Optimum Value: A++)
Mains Frequency	50 Hz
Nominal Beam Angle	30°
Nominal Light Output	90 lm
Nominal Power Consumption	20 W
Operating Voltage	230 V
Start-Up Time Until 60% of Full Light Output Has Been Reached (max.)	1 s
Weighted Energy Consumption	20 kWh/1000h
Bulb Serves as Replacement for Standard Bulbs of This Size	R50
Suitable for Accent Lighting	Yes - Beam Angle $\varphi 90^\circ$



Lighting

LED	Halogen 230 V	Halogen 12 V	Fluorescent lamps	Starter
-----	---------------	--------------	-------------------	---------



Halogen Reflector Bulb R50, 30W, E14, warm white, 1 piece

Can be Dimmed	✓
Colour Temperature	2700 K
Design	R 50
Nominal Service Life	2000 h
Number of Switching Cycles until Premature Failure (min.)	50000
Operating Position	360°
Optimal Ambient Temperature	25 °C
Power Consumption of an Equivalent Incandescent Lamp	40 W
Socket	E 14
Diameter	50 mm
Dimensions Differ From Those of a Standardized Bulb	-
Height	86.5 mm
Energy Efficiency Class	D (Scale from A++ to E, Optimum Value: A++)
Mains Frequency	50 Hz
Nominal Beam Angle	30°
Nominal Light Output	170 lm
Nominal Power Consumption	30 W
Operating Voltage	230 V
Start-Up Time Until 60% of Full Light Output Has Been Reached (max.)	0 s
Weighted Energy Consumption	30 kWh/1000h
Bulb Serves as Replacement for Standard Bulbs of This Size	R50
Suitable for Accent Lighting	Yes - Beam Angle <90° (φ90°)



Halogen Reflector Bulb R63, 30W, E27, warm white, 1 piece

Can be Dimmed	✓
Colour Temperature	2700 K
Design	R 63
Nominal Service Life	2000 h
Number of Switching Cycles until Premature Failure (min.)	50000
Operating Position	360°
Optimal Ambient Temperature	25 °C
Power Consumption of an Equivalent Incandescent Lamp	40 W
Socket	E 27
Diameter	63 mm
Dimensions Differ From Those of a Standardized Bulb	-
Height	105 mm
Energy Efficiency Class	D (Scale from A++ to E, Optimum Value: A++)
Mains Frequency	50 Hz
Nominal Beam Angle	30°
Nominal Light Output	180 lm
Nominal Power Consumption	30 W
Operating Voltage	230 V
Start-Up Time Until 60% of Full Light Output Has Been Reached (max.)	0 s
Weighted Energy Consumption	30 kWh/1000h
Bulb Serves as Replacement for Standard Bulbs of This Size	R 63
Suitable for Accent Lighting	Yes - Beam Angle <90° (φ90°)



Halogen Reflector Bulb R63, 46W, E27, warm white, 1 piece

Can be Dimmed	✓
Colour Temperature	2700 K
Design	R 63
Nominal Service Life	2000 h
Number of Switching Cycles until Premature Failure (min.)	50000
Operating Position	360°
Optimal Ambient Temperature	25 °C
Power Consumption of an Equivalent Incandescent Lamp	60 W
Socket	E 27
Diameter	63 mm
Dimensions Differ From Those of a Standardized Bulb	-
Height	105 mm
Energy Efficiency Class	D (Scale from A++ to E, Optimum Value: A++)
Mains Frequency	50 Hz
Nominal Beam Angle	30°
Nominal Light Output	300 lm
Nominal Power Consumption	46 W
Operating Voltage	230 V
Start-Up Time Until 60% of Full Light Output Has Been Reached (max.)	0 s
Weighted Energy Consumption	46 kWh/1000h
Bulb Serves as Replacement for Standard Bulbs of This Size	R 63
Suitable for Accent Lighting	Yes - Beam Angle <90° (φ90°)



Lighting
Coffee & Tea
Household goods & Decoration
Small household appliances
Cleaning & Care
Energy & Technology
Accessories for household appliances

Lighting

LED	Halogen 230 V	Halogen 12 V	Fluorescent lamps	Starter
-----	---------------	--------------	-------------------	---------

Light bulb shape

Drop shape

Candle shape

Reflector lamps

G 9 lamps

GU 10 lamps

R 7S lamps

- brilliant accent lighting
- sturdy coiled design
- suitable for use in open lamps according to IEC 60598-1
- can be dimmed
- complies with IEC 60432-3 thanks to integrated fuse function



HV Halogen Capsule, 20W, G9, clear, warm white

Angle of Radiation	360 °
Can be Dimmed	✓
Colour Temperature	2700 K
Design	Base Pin
Nominal Service Life	2000 h
Number of Switching Cycles until Premature Failure (min.)	50000
Operating Position	360 °
Optimal Ambient Temperature	25 °C
Power Consumption of an Equivalent Incandescent Lamp	25 W
Diameter	14 mm
Height	43 mm
Energy Efficiency Class	D (Scale from A++ to E, Optimum Value: A++)
Nominal Light Output	235 lm
Mains Frequency	50 Hz
Nominal Power Consumption	20 W
Operating Voltage	230 V
Start-Up Time Until 60% of Full Light Output Has Been Reached (max.)	1 s
Weighted Energy Consumption	20 kWh/1000h
Light Colour	Warm White



HV Halogen Capsule, 33W, G9, clear, warm white

Angle of Radiation	360 °
Can be Dimmed	✓
Colour Temperature	2700 K
Design	Base Pin
Nominal Service Life	2000 h
Number of Switching Cycles until Premature Failure (min.)	50000
Operating Position	360 °
Optimal Ambient Temperature	25 °C
Power Consumption of an Equivalent Incandescent Lamp	40 W
Diameter	14 mm
Height	43 mm
Energy Efficiency Class	D (Scale from A++ to E, Optimum Value: A++)
Nominal Light Output	460 lm
Mains Frequency	50 Hz
Nominal Power Consumption	33 W
Operating Voltage	230 V
Start-Up Time Until 60% of Full Light Output Has Been Reached (max.)	1 s
Weighted Energy Consumption	33 kWh/1000h
Light Colour	Warm White

112417

10	BC	
90 x 180		

4 047443 287311

112418

10	BC	
90 x 180		

4 047443 287328

Lighting



HV Halogen Capsule, 48W, G9, clear, warm white

Angle of Radiation	360°
Can be Dimmed	✓
Colour Temperature	2800 K
Design	Base Pin
Nominal Service Life	2000 h
Number of Switching Cycles until Premature Failure (min.)	50000
Operating Position	360°
Optimal Ambient Temperature	25 °C
Power Consumption of an Equivalent Incandescent Lamp	60 W
Diameter	14 mm
Height	43 mm
Energy Efficiency Class	D (Scale from A++ to E, Optimum Value: A++)
Nominal Light Output	740 lm
Mains Frequency	50 Hz
Nominal Power Consumption	48 W
Operating Voltage	230 V
Start-Up Time Until 60% of Full Light Output Has Been Reached (max.)	0 s
Weighted Energy Consumption	48 kWh/1000h
Light Colour	Warm White



Light bulb shape

Drop shape

Candle shape

Reflector lamps

G 9 lamps

GU 10 lamps

R 7S lamps

- brilliant accent lighting
- sturdy coiled design
- suitable for use in open lamps according to IEC 60598-1
- can be dimmed
- complies with IEC 60432-3 thanks to integrated fuse function



HV Halogen Reflector Bulb, 20W, GU10, PAR16, warm white

Can be Dimmed	✓
Colour Temperature	2700 K
Design	PAR 16
Nominal Service Life	2000 h
Number of Switching Cycles until Premature Failure (min.)	50000
Operating Position	360°
Optimal Ambient Temperature	25 °C
Power Consumption of an Equivalent Incandescent Lamp	20 W
Socket	GU 10
Diameter	51 mm
Dimensions Differ From Those of a Standardized Bulb	-
Height	55 mm
Energy Efficiency Class	D (Scale from A++ to E, Optimum Value: A++)
Mains Frequency	50 Hz
Nominal Beam Angle	35°
Nominal Light Output	100 lm
Nominal Power Consumption	20 W
Operating Voltage	230 V
Start-Up Time Until 60% of Full Light Output Has Been Reached (max.)	1 s
Weighted Energy Consumption	20 kWh/1000h
Bulb Serves as Replacement for Standard Bulbs of This Size	PAR 16
Suitable for Accent Lighting	Yes - Beam Angle <90° (φ90°)



Lighting

LED	Halogen 230 V	Halogen 12 V	Fluorescent lamps	Starter
-----	---------------	--------------	-------------------	---------



HV Halogen Reflector Bulb, 30W, GU10, PAR16, warm white

Can be Dimmed	✓
Colour Temperature	2700 K
Design	PAR 16
Nominal Service Life	2000 h
Number of Switching Cycles until Premature Failure (min.)	50000
Operating Position	360 °
Optimal Ambient Temperature	25 °C
Power Consumption of an Equivalent Incandescent Lamp	35 W
Socket	GU 10
Diameter	51 mm
Dimensions Differ From Those of a Standardized Bulb	-
Height	53 mm
Energy Efficiency Class	D (Scale from A++ to E, Optimum Value: A++)
Mains Frequency	50 Hz
Nominal Beam Angle	30 °
Nominal Light Output	200 lm
Nominal Power Consumption	30 W
Operating Voltage	230 V
Start-Up Time Until 60% of Full Light Output Has Been Reached (max.)	1 s
Weighted Energy Consumption	30 kWh/1000h
Bulb Serves as Replacement for Standard Bulbs of This Size	PAR 16
Suitable for Accent Lighting	Yes - Beam Angle <90° (φ90°)



HV Halogen Reflector Bulb, 42W, GU10, PAR16, warm white

Can be Dimmed	✓
Colour Temperature	2800 K
Design	PAR 16
Nominal Service Life	2000 h
Number of Switching Cycles until Premature Failure (min.)	50000
Operating Position	360 °
Optimal Ambient Temperature	25 °C
Power Consumption of an Equivalent Incandescent Lamp	50 W
Socket	GU 10
Diameter	51 mm
Dimensions Differ From Those of a Standardized Bulb	-
Height	53 mm
Energy Efficiency Class	D (Scale from A++ to E, Optimum Value: A++)
Mains Frequency	50 Hz
Nominal Beam Angle	30 °
Nominal Light Output	300 lm
Nominal Power Consumption	42 W
Operating Voltage	230 V
Start-Up Time Until 60% of Full Light Output Has Been Reached (max.)	1 s
Weighted Energy Consumption	42 kWh/1000h
Bulb Serves as Replacement for Standard Bulbs of This Size	PAR 16
Suitable for Accent Lighting	Yes - Beam Angle <90° (φ90°)

112421

6	BC
90 x 180	

4 047443 287359

112422

6	BC
90 x 180	

4 047443 287366

Lighting

LED	Halogen 230 V	Halogen 12 V	Fluorescent lamps	Starter
-----	---------------	--------------	-------------------	---------

Light bulb shape

Drop shape

Candle shape

Reflector lamps

G 9 lamps

GU 10 lamps

R 7S lamps

- halogen tubes, the ideal light source for floodlighting both indoors and outdoors
- very good light yield and small dimensions
- can be dimmed



HV Halogen Tube, 80W, R7S, 78mm, warm white

Angle of Radiation	360 °
Can be Dimmed	✓
Colour Temperature	2950 K
Design	J
Nominal Service Life	2000 h
Number of Switching Cycles until Premature Failure (min.)	50000
Operating Position	15 °
Optimal Ambient Temperature	25 °C
Power Consumption of an Equivalent Incandescent Lamp	100 W
Diameter	12 mm
Height	74,9 mm
Energy Efficiency Class	C (Scale from A++ to E, Optimum Value: A++)
Nominal Light Output	1400 lm
Mains Frequency	50 Hz
Nominal Power Consumption	80 W
Operating Voltage	230 V
Start-Up Time Until 60% of Full Light Output Has Been Reached (max.)	1 s
Weighted Energy Consumption	80 kWh/1000h
Light Colour	Warm White

112423

10	BC	
92 x 180		

4 047443 289049



HV Halogen Tube, 120W, R7S, 78mm, warm white

Angle of Radiation	360 °
Can be Dimmed	✓
Colour Temperature	2950 K
Design	J
Nominal Service Life	2000 h
Number of Switching Cycles until Premature Failure (min.)	50000
Operating Position	15 °
Optimal Ambient Temperature	25 °C
Power Consumption of an Equivalent Incandescent Lamp	150 W
Diameter	12 mm
Height	74,9 mm
Energy Efficiency Class	C (Scale from A++ to E, Optimum Value: A++)
Nominal Light Output	2250 lm
Mains Frequency	50 Hz
Nominal Power Consumption	120 W
Operating Voltage	230 V
Start-Up Time Until 60% of Full Light Output Has Been Reached (max.)	1 s
Weighted Energy Consumption	120 kWh/1000h
Light Colour	Warm White

112424

10	BC	
92 x 180		

4 047443 289056

Lighting

Coffee & Tea

Household goods & Decoration

Small household appliances

Cleaning & Care

Energy & Technology

Accessories for household appliances

Lighting

LED	Halogen 230 V	Halogen 12 V	Fluorescent lamps	Starter
-----	---------------	--------------	-------------------	---------



HV Halogen Tube, 160W, R7S, 118mm, warm white

Angle of Radiation	360 °
Can be Dimmed	✓
Colour Temperature	2900 K
Design	J
Nominal Service Life	2000 h
Number of Switching Cycles until Premature Failure (min.)	50000
Operating Position	15 °
Optimal Ambient Temperature	25 °C
Power Consumption of an Equivalent Incandescent Lamp	200 W
Diameter	12 mm
Height	114,2 mm
Energy Efficiency Class	C (Scale from A++ to E, Optimum Value: A++)
Nominal Light Output	3100 lm
Mains Frequency	50 Hz
Nominal Power Consumption	160 W
Operating Voltage	230 V
Start-Up Time Until 60% of Full Light Output Has Been Reached (max.)	1 s
Weighted Energy Consumption	160 kWh/1000h
Light Colour	Warm White



HV Halogen Tube, 230W, R7S, 118mm, warm white

Angle of Radiation	360 °
Can be Dimmed	✓
Colour Temperature	2950 K
Design	J
Nominal Service Life	2000 h
Number of Switching Cycles until Premature Failure (min.)	50000
Operating Position	15 °
Optimal Ambient Temperature	25 °C
Power Consumption of an Equivalent Incandescent Lamp	300 W
Diameter	12 mm
Height	119,6 mm
Energy Efficiency Class	C (Scale from A++ to E, Optimum Value: A++)
Nominal Light Output	5000 lm
Mains Frequency	50 Hz
Nominal Power Consumption	160 W
Operating Voltage	230 V
Start-Up Time Until 60% of Full Light Output Has Been Reached (max.)	1 s
Weighted Energy Consumption	230 kWh/1000h
Light Colour	Warm White



HV Halogen Tube, 400W, R7S, 118mm, warm white

Angle of Radiation	360 °
Can be Dimmed	✓
Colour Temperature	3000 K
Design	J
Nominal Service Life	2000 h
Number of Switching Cycles until Premature Failure (min.)	50000
Operating Position	15 °
Optimal Ambient Temperature	25 °C
Power Consumption of an Equivalent Incandescent Lamp	500 W
Diameter	12 mm
Height	119,6 mm
Energy Efficiency Class	C (Scale from A++ to E, Optimum Value: A++)
Nominal Light Output	9000 lm
Mains Frequency	50 Hz
Nominal Power Consumption	400 W
Operating Voltage	230 V
Start-Up Time Until 60% of Full Light Output Has Been Reached (max.)	1 s
Weighted Energy Consumption	400 kWh/1000h
Light Colour	Warm White

		112425
10	BC	
90 x 180		
4		047443 289063

		112426
10	BC	
90 x 180		
4		047443 289070

		112427
10	BC	
90 x 180		
4		047443 289087

G 4

GY 6,35

GU 4

GU 5,3

- brilliant accent lighting
- ingeniously compact for revolutionary new lamp designs
- suitable for use in open lamps according to IEC 60598-1
- can be dimmed



LV Halogen Capsule, 10W, G4, warm white, 2 pieces

Angle of Radiation	360 °
Can be Dimmed	✓
Colour Temperature	2800 K
Design	Base Pin
Nominal Service Life	2000 h
Number of Switching Cycles until Premature Failure (min.)	50000
Operating Position	360 °
Optimal Ambient Temperature	25 °C
Power Consumption of an Equivalent Incandescent Lamp	17 W
Socket	G 4
Diameter	10 mm
Height	33 mm
Energy Efficiency Class	C (Scale from A++ to E, Optimum Value: A++)
Nominal Light Output	140 lm
Mains Frequency	AC Voltage
Nominal Power Consumption	10 W
Operating Voltage	12 V
Start-Up Time Until 60% of Full Light Output Has Been Reached (max.)	0 s
Weighted Energy Consumption	11 kWh/1000h
Light Colour	Warm White

112428

10	BC
90 x 180	

4 047443 287380



LV Halogen Capsule, 20W, G4, warm white, 2 pieces

Angle of Radiation	360 °
Can be Dimmed	✓
Colour Temperature	2800 K
Design	Base Pin
Nominal Service Life	2000 h
Number of Switching Cycles until Premature Failure (min.)	50000
Operating Position	360 °
Optimal Ambient Temperature	25 °C
Power Consumption of an Equivalent Incandescent Lamp	33 W
Socket	G 4
Diameter	10 mm
Height	33 mm
Energy Efficiency Class	C (Scale from A++ to E, Optimum Value: A++)
Nominal Light Output	320 lm
Mains Frequency	AC Voltage
Nominal Power Consumption	20 W
Operating Voltage	12 V
Start-Up Time Until 60% of Full Light Output Has Been Reached (max.)	1 s
Weighted Energy Consumption	22 kWh/1000h
Light Colour	Warm White

112429

10	BC
90 x 180	

4 047443 287403

Lighting

LED	Halogen 230 V	Halogen 12 V	Fluorescent lamps	Starter
-----	---------------	---------------------	-------------------	---------

G 4

GY 6,35

GU 4

GU 5,3

- brilliant accent lighting
- ingeniously compact for revolutionary new lamp designs
- suitable for use in open lamps according to IEC 60598-1
- can be dimmed



LV Halogen Capsule, 20W, GY6.35, warm white, 2 pieces

Angle of Radiation	360 °
Can be Dimmed	✓
Colour Temperature	2800 K
Design	Base Pin
Nominal Service Life	4000 h
Number of Switching Cycles until Premature Failure (min.)	100000
Operating Position	360 °
Optimal Ambient Temperature	25 °C
Power Consumption of an Equivalent Incandescent Lamp	31 W
Socket	GY 6.35
Diameter	12 mm
Height	44 mm
Energy Efficiency Class	C (Scale from A++ to E, Optimum Value: A++)
Nominal Light Output	290 lm
Mains Frequency	AC Voltage
Nominal Power Consumption	20 W
Operating Voltage	12 V
Start-Up Time Until 60% of Full Light Output Has Been Reached (max.)	1 s
Weighted Energy Consumption	22 kWh/1000h
Light Colour	Warm White

112430

10	BC	
90 x 180		

4 047443 287410



LV Halogen Capsule, 35W, GY6.35, warm white, 2 pieces

Angle of Radiation	360 °
Can be Dimmed	✓
Colour Temperature	2900 K
Design	Base Pin
Nominal Service Life	2000 h
Number of Switching Cycles until Premature Failure (min.)	50000
Operating Position	360 °
Optimal Ambient Temperature	25 °C
Power Consumption of an Equivalent Incandescent Lamp	53 W
Socket	GY 6.35
Diameter	12 mm
Height	44 mm
Energy Efficiency Class	C (Scale from A++ to E, Optimum Value: A++)
Nominal Light Output	600 lm
Mains Frequency	AC Voltage
Nominal Power Consumption	35 W
Operating Voltage	12 V
Start-Up Time Until 60% of Full Light Output Has Been Reached (max.)	1 s
Weighted Energy Consumption	38 kWh/1000h
Light Colour	Warm White

112431

10	BC	
90 x 180		

4 047443 287427



LV Halogen Capsule, 50W, GY6.35, warm white, 2 pieces

Angle of Radiation	360°
Can be Dimmed	✓
Colour Temperature	3000 K
Design	Base Pin
Nominal Service Life	2000 h
Number of Switching Cycles until Premature Failure (min.)	50000
Operating Position	360°
Optimal Ambient Temperature	25 °C
Power Consumption of an Equivalent Incandescent Lamp	74 W
Socket	GY 6.35
Diameter	12 mm
Height	44 mm
Energy Efficiency Class	C (Scale from A++ to E, Optimum Value: A++)
Nominal Light Output	910 lm
Mains Frequency	AC Voltage
Nominal Power Consumption	50 W
Operating Voltage	12 V
Start-Up Time Until 60% of Full Light Output Has Been Reached (max.)	1 s
Weighted Energy Consumption	53 kWh/1000h
Light Colour	Warm White



G 4

GY 6,35

GU 4

GU 5,3

- cold light reflector reduces the heat buildup in the light bundle by 66%
- suitable for use in open lamps according to IEC 60598-1
- can be dimmed



LV Halogen Reflector Bulb, 20W, GU4, MR11, warm white

Can be Dimmed	✓
Colour Temperature	3000 K
Design	MR 11
Nominal Service Life	2000 h
Number of Switching Cycles until Premature Failure (min.)	50000
Operating Position	360°
Optimal Ambient Temperature	25 °C
Power Consumption of an Equivalent Incandescent Lamp	25 W
Socket	GU 4
Diameter	35 mm
Dimensions Differ From Those of a Standardized Bulb	-
Height	42 mm
Energy Efficiency Class	B (Scale from A++ to E, Optimum Value: A++)
Mains Frequency	AC Voltage
Nominal Beam Angle	36°
Nominal Light Output	205 lm
Nominal Power Consumption	20 W
Operating Voltage	12 V
Start-Up Time Until 60% of Full Light Output Has Been Reached (max.)	1 s
Weighted Energy Consumption	22 kWh/1000h
Bulb Serves as Replacement for Standard Bulbs of This Size	MR11
Suitable for Accent Lighting	Yes - Beam Angle <90° (φ90°)



Lighting

LED	Halogen 230 V	Halogen 12 V	Fluorescent lamps	Starter
-----	---------------	--------------	-------------------	---------



LV Halogen Reflector Bulb, 35W, GU4, MR11, warm white

Can be Dimmed	✓
Colour Temperature	3000 K
Design	MR 11
Nominal Service Life	2000 h
Number of Switching Cycles until Premature Failure (min.)	50000
Operating Position	360 °
Optimal Ambient Temperature	25 °C
Power Consumption of an Equivalent Incandescent Lamp	43 W
Socket	GU 4
Diameter	35 mm
Dimensions Differ From Those of a Standardized Bulb	-
Height	42 mm
Energy Efficiency Class	B (Scale from A++ to E, Optimum Value: A++)
Mains Frequency	AC Voltage
Nominal Beam Angle	36 °
Nominal Light Output	430 lm
Nominal Power Consumption	35 W
Operating Voltage	12 V
Start-Up Time Until 60% of Full Light Output Has Been Reached (max.)	1 s
Weighted Energy Consumption	38 kWh/1000h
Bulb Serves as Replacement for Standard Bulbs of This Size	MR11
Suitable for Accent Lighting	Yes - Beam Angle <90° (φ90°)

G 4

GY 6,35

GU 4

GU 5,3

- cold light reflector reduces the heat buildup in the light bundle by 66%
- suitable for use in open lamps according to IEC 60598-1
- can be dimmed



LV Halogen Reflector Bulb, 20W, GU5,3, MR16, warm white

Can be Dimmed	✓
Colour Temperature	3000 K
Design	MR 16
Nominal Service Life	2000 h
Number of Switching Cycles until Premature Failure (min.)	50000
Operating Position	360 °
Optimal Ambient Temperature	25 °C
Power Consumption of an Equivalent Incandescent Lamp	24 W
Socket	G 5.3
Diameter	51 mm
Dimensions Differ From Those of a Standardized Bulb	-
Height	45 mm
Energy Efficiency Class	B (Scale from A++ to E, Optimum Value: A++)
Mains Frequency	AC Voltage
Nominal Beam Angle	36 °
Nominal Light Output	210 lm
Nominal Power Consumption	20 W
Operating Voltage	12 V
Start-Up Time Until 60% of Full Light Output Has Been Reached (max.)	1 s
Weighted Energy Consumption	22 kWh/1000h
Bulb Serves as Replacement for Standard Bulbs of This Size	MR16
Suitable for Accent Lighting	Yes - Beam Angle <90° (φ90°)

112434

10	BC
90 x 180	

4 047443 287458

112435

10	BC
90 x 180	

4 047443 287373

Lighting

LED	Halogen 230 V	Halogen 12 V	Fluorescent lamps	Starter
-----	---------------	--------------	-------------------	---------



LV Halogen Reflector Bulb, 35W, GU5.3, MR16, warm white

Can be Dimmed	✓
Colour Temperature	3000 K
Design	MR 16
Nominal Service Life	2000 h
Number of Switching Cycles until Premature Failure (min.)	50000
Operating Position	360°
Optimal Ambient Temperature	25 °C
Power Consumption of an Equivalent Incandescent Lamp	43 W
Socket	G 5.3
Diameter	51 mm
Dimensions Differ From Those of a Standardized Bulb	-
Height	46 mm
Energy Efficiency Class	B (Scale from A++ to E, Optimum Value: A++)
Mains Frequency	AC Voltage
Nominal Beam Angle	36°
Nominal Light Output	430 lm
Nominal Power Consumption	35 W
Operating Voltage	12 V
Start-Up Time Until 60% of Full Light Output Has Been Reached (max.)	1 s
Weighted Energy Consumption	38 kWh/1000h
Bulb Serves as Replacement for Standard Bulbs of This Size	MR16
Suitable for Accent Lighting	Yes - Beam Angle <90° (φ90°)



LV Halogen Reflector Bulb, 50W, GU5.3, MR16, warm white

Can be Dimmed	✓
Colour Temperature	3000 K
Design	MR 16
Nominal Service Life	2000 h
Number of Switching Cycles until Premature Failure (min.)	50000
Operating Position	360°
Optimal Ambient Temperature	25 °C
Power Consumption of an Equivalent Incandescent Lamp	59 W
Socket	G 5.3
Diameter	51 mm
Dimensions Differ From Those of a Standardized Bulb	-
Height	46 mm
Energy Efficiency Class	B (Scale from A++ to E, Optimum Value: A++)
Mains Frequency	AC Voltage
Nominal Beam Angle	24°
Nominal Light Output	680 lm
Nominal Power Consumption	50 W
Operating Voltage	12 V
Start-Up Time Until 60% of Full Light Output Has Been Reached (max.)	1 s
Weighted Energy Consumption	53 kWh/1000h
Bulb Serves as Replacement for Standard Bulbs of This Size	MR16
Suitable for Accent Lighting	Yes - Beam Angle <90° (φ90°)

112436

10	BC
90 x 180	

4 047443 287397

112437

10	BC
90 x 180	

4 047443 289094

Lighting

T8 Quality Plus

T8 Daylight

T8 Standard

T5

- 3-band technology for excellent light yield, long service life and good colour rendering
- for all lighting jobs both indoors and outdoors



Tri-Band Fluorescent Bulb, T8 Quality Plus, 58W

Colour Temperature	4000 K
Design	T8 ø 26 mm rod-shaped
Nominal Service Life	20000 h
Socket	G 13
Length	1500 mm
Tube Diameter	26 mm
Energy Efficiency Class	A (Scale from A++ to E, Optimum Value: A++)
Nominal Light Output	5250 lm
Nominal Power Consumption	58 W
Weighted Energy Consumption	67 kWh/1000h
Light Colour	Neutral White
Suitable for Indoor Lighting at Room Temperature	✓



Triphosphor Fluorescent Bulb, T8 Quality Plus, 36W, 25 pieces

Colour Temperature	4000 K
Design	T8 ø 26 mm rod-shaped
Nominal Service Life	20000 h
Socket	G 13
Length	1200 mm
Tube Diameter	26 mm
Energy Efficiency Class	A (Scale from A++ to E, Optimum Value: A++)
Nominal Light Output	3350 lm
Nominal Power Consumption	36 W
Weighted Energy Consumption	42,3 kWh/1000h
Light Colour	Neutral White
Suitable for Indoor Lighting at Room Temperature	✓



Lighting

LED	Halogen 230 V	Halogen 12 V	Fluorescent lamps	Starter
-----	---------------	--------------	--------------------------	---------



18W Fluorescent Lamp, neutral white

Colour Temperature	4000 K
Design	T8 Ø 26 mm rod-shaped
Nominal Service Life	20000 h
Socket	G 13
Length	590 mm
Tube Diameter	28 mm
Energy Efficiency Class	A (Scale from A++ to E, Optimum Value: A++)
Nominal Light Output	1350 lm
Nominal Power Consumption	18 W
Weighted Energy Consumption	22 kWh/1000h
Light Colour	Neutral White
Suitable for Indoor Lighting at Room Temperature	✓



T8 Quality Plus

T8 Daylight

T8 Standard

T5

- 3-band technology for excellent light yield, long service life and good colour rendering
- daylight: The light emitted from this lamp has a colour spectrum that closely resembles natural daylight. This specific colour spectrum may have a stimulating effect on many people as it subconsciously enhances hormone secretion and metabolism. This may positively affect and increase physical and emotional strength



Triphosphor Fluorescent Lamp, T8, 58W, daylight

Colour Temperature	6500 K
Design	T8 Ø 26 mm rod-shaped
Nominal Service Life	20000 h
Socket	G 13
Length	1500 mm
Tube Diameter	26 mm
Energy Efficiency Class	A (Scale from A++ to E, Optimum Value: A++)
Nominal Light Output	5050 lm
Nominal Power Consumption	58 W
Weighted Energy Consumption	67,1 kWh/1000h
Light Colour	Daylight
Suitable for Indoor Lighting at Room Temperature	✓



Lighting

Coffee & Tea

Household goods & Decoration

Small household appliances

Cleaning & Care

Energy & Technology

Accessories for household appliances

Lighting

LED

Halogen 230 V

Halogen 12 V

Fluorescent lamps

Starter



**Triphosphor Fluorescent Bulb, T8
Quality Plus, 36W, 25 pieces**

**Triphosphor Fluorescent Lamp, T8,
18W, daylight**

Colour Temperature	6500 K
Design	T8 ø 26 mm rod-shaped
Nominal Service Life	18000 h
Socket	G 13
Length	1200 mm
Tube Diameter	28 mm
Energy Efficiency Class	A (Scale from A++ to E, Optimum Value: A++)
Nominal Light Output	3250 lm
Nominal Power Consumption	36 W
Weighted Energy Consumption	43 kWh/1000h
Light Colour	Daylight
Suitable for Indoor Lighting at Room Temperature	✓

Colour Temperature	6500 K
Design	T8 ø 26 mm rod-shaped
Nominal Service Life	20000 h
Socket	G 13
Length	590 mm
Tube Diameter	26 mm
Energy Efficiency Class	A (Scale from A++ to E, Optimum Value: A++)
Nominal Light Output	1300 lm
Nominal Power Consumption	18 W
Weighted Energy Consumption	22 kWh/1000h
Light Colour	Daylight
Suitable for Indoor Lighting at Room Temperature	✓



T8 Quality Plus

T8 Daylight

T8 Standard

T5

- Standard fluorescent lamp for general lighting jobs both indoors and outdoors (not as lighting in the workplace)



Fluorescent Lamp, 30W, neutral white

Colour Temperature	4000 K
Design	T8 ø 26 mm rod-shaped
Nominal Service Life	10000 h
Socket	G 13
Length	895 mm
Tube Diameter	26 mm
Energy Efficiency Class	B (Scale from A++ to E, Optimum Value: A++)
Nominal Light Output	2200 lm
Nominal Power Consumption	30 W
Weighted Energy Consumption	33 kWh/1000h
Light Colour	Neutral White
Suitable for Indoor Lighting at Room Temperature	-



Fluorescent Lamp, 18W, neutral white

Colour Temperature	4000 K
Design	T8 ø 26 mm rod-shaped
Nominal Service Life	10000 h
Socket	G 13
Length	600 mm
Tube Diameter	26 mm
Energy Efficiency Class	B (Scale from A++ to E, Optimum Value: A++)
Nominal Light Output	1200 lm
Nominal Power Consumption	18 W
Weighted Energy Consumption	22,1 kWh/1000h
Light Colour	Neutral White
Suitable for Indoor Lighting at Room Temperature	-



T8 Quality Plus

T8 Daylight

T8 Standard

T5

- 3-band technology for excellent light yield, long service life and good colour rendering
- particularly high luminous flux in a very compact design
- operates only with an electronic ballast



**Triphosphor Fluorescent Lamp,
T5 HQ 54W 840**

Colour Temperature	4000 K
Design	T5 ø 16 mm rod-shaped
Nominal Service Life	24000 h
Socket	G 5
Length	1149 mm
Tube Diameter	16 mm
Energy Efficiency Class	A (Scale from A++ to E, Optimum Value: A++)
Nominal Light Output	5000 lm
Nominal Power Consumption	54 W
Weighted Energy Consumption	60 kWh/1000h
Light Colour	Neutral White
Suitable for Indoor Lighting at Room Temperature	✓

**Triphosphor Fluorescent Lamp,
T5 EQ 35W 840**

Colour Temperature	4000 K
Design	T5 ø 16 mm rod-shaped
Nominal Service Life	24000 h
Socket	G 5
Length	1449 mm
Tube Diameter	16 mm
Energy Efficiency Class	A (Scale from A++ to E, Optimum Value: A++)
Nominal Light Output	3650 lm
Nominal Power Consumption	35 W
Weighted Energy Consumption	39 kWh/1000h
Light Colour	Neutral White
Suitable for Indoor Lighting at Room Temperature	✓



Lighting

LED	Halogen 230 V	Halogen 12 V	Fluorescent lamps	Starter
-----	---------------	--------------	-------------------	---------



Triphosphor Fluorescent Lamp, T5 EQ 28W 840

Colour Temperature	4000 K
Design	T5 ø 16 mm rod-shaped
Nominal Service Life	24000 h
Socket	G 5
Length	1149 mm
Tube Diameter	16 mm
Energy Efficiency Class	A (Scale from A++ to E, Optimum Value: A++)
Nominal Light Output	2900 lm
Nominal Power Consumption	28 W
Weighted Energy Consumption	31 kWh/1000h
Light Colour	Neutral White
Suitable for Indoor Lighting at Room Temperature	✓

Triphosphor Fluorescent Lamp, T5 HQ 24W 840

Colour Temperature	4000 K
Design	T5 ø 16 mm rod-shaped
Nominal Service Life	24000 h
Socket	G 5
Length	549 mm
Tube Diameter	16 mm
Energy Efficiency Class	A (Scale from A++ to E, Optimum Value: A++)
Nominal Light Output	2000 lm
Nominal Power Consumption	24 W
Weighted Energy Consumption	27 kWh/1000h
Light Colour	Neutral White
Suitable for Indoor Lighting at Room Temperature	✓

Triphosphor Fluorescent Lamp, T5 EQ 21W 840

Colour Temperature	4000 K
Design	T5 ø 16 mm rod-shaped
Nominal Service Life	24000 h
Socket	G 5
Length	849 mm
Tube Diameter	16 mm
Energy Efficiency Class	A (Scale from A++ to E, Optimum Value: A++)
Nominal Light Output	2100 lm
Nominal Power Consumption	21 W
Weighted Energy Consumption	24 kWh/1000h
Light Colour	Neutral White
Suitable for Indoor Lighting at Room Temperature	✓

4 CB 110591

 4 047443 011008

25 CB 110590

 4 047443 010995

4 CB 110589

 4 047443 010988

Lighting

Fluorescent lamp starter

- lights up quickly, safely and gently for the lamp



"ST 65 Single" Fluorescent Bulb Starter, 2 pieces

"ST 20 Duo" Fluorescent Bulb Starter, 2 pieces

Number of Starters	2
Dimension	39 x 21 mm
Voltage	240 V
Application 1	Fluorescent Bulbs Single Circuits for 4-65 W, 80 W
Application 2	Compact Fluorescent Bulbs for 18 W, 24 W, 36 W
VDE Tested	✓

Number of Starters	2
Dimension	39 x 21 mm
Voltage	240 V
Application 1	Compact Fluorescent Bulbs for 18 W, 24 W
Application 2	Fluorescent Bulbs Tandem Switching for 4, 6, 8, 15, 18, 20, 22 W
VDE Tested	✓

110456

6	CB	
90 x 155		

4 047443 002686

110458

6	CB	
90 x 155		

4 047443 003539



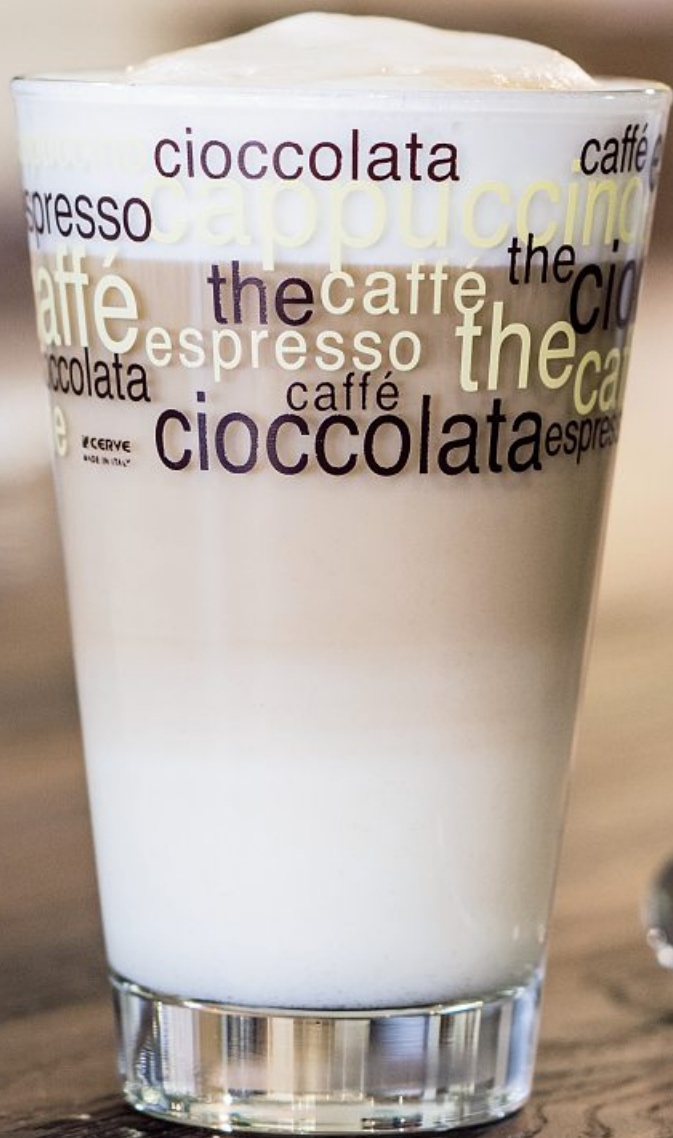

cioccolata caffè
espresso cappuccino
caffé the caffè the
cioccolata espresso the ca
caffé
#CERVE
MADE IN ITALY
cioccolata espresso

Coffee & Tea

Dishes	104
Storage & Presentation	114
Preparation	129
Machine Accessories	137





Coffee & Tea

The first cup of coffee in the morning. Taking a break for afternoon tea. In any circumstance, at any time, we drink coffee and tea. In the meantime it's become a passion and indulgence that forms a part of today's lifestyle. Enjoy these moments even more with attractive cups and glasses in premium designs from Xavax. Modern capsule stands and aroma-preserving storage containers will hold your pads, powders, beans and bags ready at hand. Special cleaning and preparation accessories top off the Xavax range.





More and more pad and capsule coffee machines are becoming available. With more different systems come more different types of coffee, too. Xavax offers elegant storage stands for the perfect presentation; they cover every conceivable capsule variety and accommodate capsules from any brand you can think of, from Aldi to Tchibo.



Coffee & Tea

Dishes

Storage & Presentation

Preparation

Machine Accessories

Insulated Mug

Insulated flask

Insulated bottle

Drinking glass

Cup set



"Office" Vacuum Mug, blue

"Office" Vacuum Mug, red

Capacity	300 ml
Diameter (bottom)	5.7 cm
Diameter (top)	8.5 cm
Height	12.5 cm

Capacity	300 ml
Diameter (bottom)	5.7 cm
Diameter (top)	8.5 cm
Height	12.5 cm

- Elegant vacuum mug for on the go or for use in the office
- Suitable for any hot or cold beverage
- Uses special insulation to keep the beverage at a consistent temperature for a long time
- Handle and lid made of black plastic
- Lid with closable drink-through opening to prevent your beverage from spilling
- Coloured plastic exterior and stainless steel liner
- Ideal height for pod machines and fully automatic machines
- Fits in most cup holders in the car

- Elegant vacuum mug for on the go or for use in the office
- Suitable for any hot or cold beverage
- Uses special insulation to keep the beverage at a consistent temperature for a long time
- Handle and lid made of black plastic
- Lid with closable drink-through opening to prevent your beverage from spilling
- Coloured plastic exterior and stainless steel liner
- Ideal height for pod machines and fully automatic machines
- Fits in most cup holders in the car





"Car" Insulated Mug

Capacity	400 ml
Diameter above	8 cm
Diameter below	6.4 cm
Height	19 cm

- Vacuum mug for hot and cold beverages, specially designed to fit all standard cup holders in a car
- Uses insulated insulation to keep the beverage at a consistent temperature for a long time
- Handle and lid made of black plastic
- Lid with closable drink-through opening to prevent your beverage from spilling
- Matt stainless steel exterior and plastic liner
- Lies well in the hand thanks to grooves in the handle



"Ergotherm" Insulated Mug

Capacity	350 ml
Diameter above	7.5 cm
Diameter below	6.5 cm
Height	18.5 cm

- Stable, elegant vacuum mug for cold or hot beverages, ideal for use on the go or in the office
- Thanks to its special shape, the mug lies well in the hand and fits in all standard cup holders in the car
- Lid with closable drink-through opening to prevent your beverage from spilling
- The paper insert can be designed individually; instead of that you can also insert your own photos, etc.



"Teatime" Insulated Mug

Capacity	350 ml
Diameter above	7.5 cm
Diameter below	6.5 cm
Height	18.5 cm

- Stable, elegant vacuum mug for cold or hot beverages, ideal for use on the go or in the office
- Lid with closable drink-through opening to prevent your beverage from spilling
- Fits in all standard cup holders in the car
- The mug can be opened: paper insert so that you can easily change the design of the mug or for inserting your own photos



Coffee & Tea

Dishes	Storage & Presentation	Preparation	Machine Accessories
--------	------------------------	-------------	---------------------



"Travel" Drinking Cup, 0.4l, blue

Capacity	0.4 ml
Diameter (bottom)	6.7 cm
Diameter (top)	8 cm
Height	21 cm

- Suitable for any hot or cold beverage
- Ideal for outdoor activities, travel, school or for the office
- Screw-on lid with a silicone seal to prevent your beverage from spilling
- One-handed operation, easy to open and close at the touch of a button
- Fits in many cup holders in the car



"Travel" Drinking Cup, 0.4l, pink

Capacity	0.4 ml
Diameter (bottom)	6.7 cm
Diameter (top)	8 cm
Height	21 cm

- Suitable for any hot or cold beverage
- Ideal for outdoor activities, travel, school or for the office
- Screw-on lid with a silicone seal to prevent your beverage from spilling
- One-handed operation, easy to open and close at the touch of a button
- Fits in many cup holders in the car



"Travel" Drinking Cup, 0.4l, green

Capacity	0.4 ml
Diameter (bottom)	6.7 cm
Diameter (top)	8 cm
Height	21 cm

- Suitable for any hot or cold beverage
- Ideal for outdoor activities, travel, school or for the office
- Screw-on lid with a silicone seal to prevent your beverage from spilling
- One-handed operation, easy to open and close at the touch of a button
- Fits in many cup holders in the car





xavax[®]



"Travel" Drinking Cup, 0.4l

Travel mug ideal for use on the go
Suitable for any hot or cold beverage

Item No. 0111200 – 0111202

Coffee & Tea

Dishes

Storage & Presentation

Preparation

Machine Accessories

Insulated Mug

Insulated flask

Insulated bottle

Drinking glass

Cup set



"Piccolo" Insulated Jug, 0.4 l

Material Outside	Stainless Steel
Filling Quantity	400 ml
Colour	Stainless Steel

- With a height of just 12 cm, this insulated jug can be used for almost all fully automatic coffee machines
- The coffee flows directly into the jug, therefore no need to refill the beverage-
- Screwable lid with one hand push button operation
- Sturdy and robust (stainless steel interior and exterior)
- The sturdy handle provides a secure hold
- Capacity: 4 cups (with 100 ml each) or 2 mugs (with 200 ml each)



"Mezzo 1.5" Insulated Jug

Material Outside	Stainless Steel
Filling Quantity	1500 ml
Colour	Stainless Steel

- Screwable lid with one hand push button operation
- Sturdy and robust (stainless steel interior and exterior)
- Large opening for easy internal cleaning
- Lies well in the hand thanks to grooves in the handle
- Capacity: at least 8 coffee cups





"Grande 2.0" Insulated Jug

"Terreo Mezzo 1.5" Insulated Jug

Material Outside	Stainless Steel
Filling Quantity	2000 ml
Colour	Stainless Steel

Material Outside	Stainless Steel
Filling Quantity	1500 ml
Colour	Oriental Red

- Screwable lid with one hand push button operation
- Sturdy and robust (stainless steel interior and exterior)
- Large opening for easy internal cleaning
- Lies well in the hand thanks to grooves in the handle
- Capacity: at least 10 coffee cups

- Special coat in oriental red tone prevents streaks and marks as they are usual e.g. with stainless steel
- Screwable lid with one hand push button operation
- Sturdy and robust (stainless steel interior and exterior)
- Large opening for easy internal cleaning
- The sturdy handle provides a secure hold
- Capacity: at least 8 cups



Coffee & Tea

Dishes

Storage & Presentation

Preparation

Machine Accessories

Insulated Mug

Insulated flask

Insulated bottle

Drinking glass

Cup set



"Birillo 0.5" Vacuum Flask, red

"Teatime" Insulated Mug

Filling Quantity	500 ml
Height	250 mm

Filling Quantity	500 ml
Height	250 mm

- The conical shape makes the Insulated flask comfortable to hold
- High-quality finish in transparent ruby-red
- Push button for pouring out the beverage and reclosing the flask quickly
- The screw cap can also be used as drinking cup

- The conical shape makes the Insulated flask comfortable to hold
- High-quality finish in transparent midnight blue
- Push button for pouring out the beverage and reclosing the flask quickly
- The screw cap can also be used as drinking cup



- Insulated Mug
- Insulated flask
- Insulated bottle
- Drinking glass
- Cup set



Glass Coffee Cup, with decorations, 6 pieces

Capacity	380 ml
Height	10 cm
Suitable for Dishwashers	✓
Suitable for Microwaves	✓

- Sturdy, high-quality coffee glass with attractive decorations
- Stackable



"Happy" Tea Cup, glass, 6 pieces

Capacity	260 ml
Height	9.8 cm
Suitable for Dishwashers	✓
Suitable for Microwaves	✓

- This sturdy, high-quality tea glass is ideal for tea drinks
- Attractive tea design with the inscription "Tee macht glücklich"
- Stackable



Dishes

Storage & Presentation

Preparation

Machine Accessories



"Flavoured Taste"
Latte Macchiato Glass, 6 pieces

Capacity	375 ml
Height	13,5 cm
Suitable for Dishwashers	✓
Suitable for Microwaves	✓

- Universally suitable for most coffee pod machines
- Ideal for latte macchiato, but also suitable for iced coffee, ice shakes or iced tea
- Glass with an attractive shape and a modern, fresh design
- Stackable



- Insulated Mug
- Insulated flask
- Insulated bottle
- Drinking glass
- Cup set



"Espresso Time" Espresso Cup Set, 12 parts

Capacity of cup	80 ml
Diameter Cup	6 cm
Diameter Saucer	12.5 cm
Height Cup	4.5 cm
Suitable for Dishwashers	✓
Suitable for Microwaves	✓

- 12-part espresso cup set
- Suitable for Microwaves: no specifications
- Unobtrusive coffee bean design (green, blue and red in colour)
- Assorted colours (2 cups and saucers each)
- Cylindrical espresso cup shape
- Convenient gift packaging
- Complies with the requirements of the German Foods, Consumer Goods and Feedstuffs Code (LFGB) and 1935/2004/EC



"Hot&More" Glass Cup, glass, set of 2

Capacity of cup	300 ml
Diameter Cup	8 cm
Diameter Saucer	-
Height Cup	10 cm
Suitable for Dishwashers	✓
Suitable for Microwaves	✓

- This sturdy, high-quality glass is ideal for tea drinks
- Also for coffee, hot chocolate and more
- Attractive design with "Hot&More" inscription
- Stackable



Coffee & Tea

Dishes

Storage & Presentation

Preparation

Machine Accessories

Coffee pad container

Coffee/tea container

Capsule holder/stand

Tray



Box for Coffee Pads, pink/green/orange/blue, 12 pieces in a cardboard box

Diameter	8 cm
Height	18 cm

- Metal box for up to 20 tea or coffee pads, preserves the aroma
- Suitable for all common pad sizes
- Protected from light
- Inscrutable lid (for waterproof pens)



"Padsafe" Pod Container, silver, 12 pieces in a cardboard box

Diameter	8 cm
Height	18.5 cm

- Metal container for storing up to 20 different pads and for keeping the aroma
- Suitable for all common pod sizes
- Protected against light
- The lid can be written on (with waterproof markers)
- Each set contains 4 different decorations with refreshing coffee designs





"City" pad container

Suitable for all common pad sizes
Includes four different city motifs per set

Item No. 111184

Coffee & Tea

Dishes

Storage & Presentation

Preparation

Machine Accessories



**"City" Pad Box,
12 pieces in a cardboard box**

Diameter	7,5 cm
Height	17,5 cm

- Suitable for all common pad sizes
- Protected from light
- Each set contains 4 different decorations with refreshing city designs



**"New York" Pad Box,
6 pieces in a cardboard box**

Diameter	7,5 cm
Height	17,5 cm

- Suitable for all common pad sizes
- Protected from light
- With a refreshing city design



**"Paris" Pad Box,
6 pieces in a cardboard box**

Diameter	7,5 cm
Height	17,5 cm

- Suitable for all common pad sizes
- Protected from light
- With a refreshing city design



**"London" Pad Box,
6 pieces in a cardboard box**

Diameter	7,5 cm
Height	17,5 cm

- Suitable for all common pad sizes
- Protected from light
- With a refreshing city design



**"Berlin" Pad Box,
6 pieces in a cardboard box**

Diameter	7,5 cm
Height	17,5 cm

- Suitable for all common pad sizes
- Protected from light
- With a refreshing city design





**"Wien" Pad Box,
6 pieces in a cardboard box**

Diameter	7,5 cm
Height	17,5 cm

- Suitable for all common pad sizes
- Protected from light
- With a refreshing city design



**"Prag" Pad Box,
6 pieces in a cardboard box**

Diameter	7,5 cm
Height	17,5 cm

- Suitable for all common pad sizes
- Protected from light
- With a refreshing city design



**"Madrid" Pad Box,
6 pieces in a cardboard box**

Diameter	7,5 cm
Height	17,5 cm

- Suitable for all common pad sizes
- Protected from light
- With a refreshing city design



**"Rom" Pad Box,
6 pieces in a cardboard box**

Diameter	7,5 cm
Height	17,5 cm

- Suitable for all common pad sizes
- Protected from light
- With a refreshing city design



Lighting

Coffee & Tea

Household goods & Decoration

Small household appliances

Cleaning & Care

Energy & Technology

Accessories for household appliances

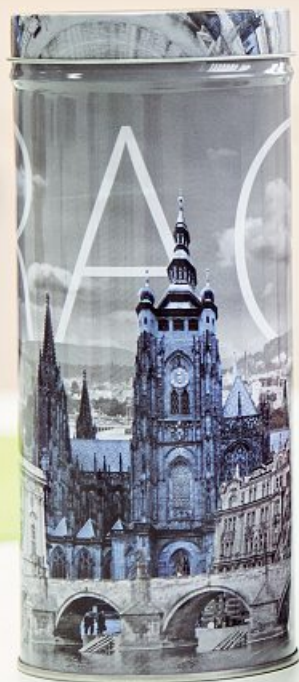

xavax[®]



"City" pad container

Suitable for all common pad sizes

Item No. 111207/08/09/10

- Coffee pad container
- Coffee/tea container**
- Capsule holder/stand
- Tray



Stainless Steel Canister for 1 kg of Coffee Beans

Capacity	1000 g
Height	21.8 cm
Width	17 cm

- Stainless steel canister for storing up to one kilo of whole coffee beans
- Also ideal for tea, hot chocolate, etc.
- Twist-off cap and side handle makes it easy to open and close the canister
- Recess on the plastic handle for storing a coffee measuring spoon
- The airtight lid with a date label closes securely and reliably with a quarter turn, allowing the tea or coffee to keep its full aroma for longer
- Compartment inside the lid to preserve the aroma (can be used for moisture absorbent granules, fragrances, etc.)

111149

12	BA	
4 047443 141569		

Lighting

Coffee & Tea

Household goods & Decoration

Small household appliances

Cleaning & Care

Energy & Technology

Accessories for household appliances

- Coffee pad container
- Coffee/tea container
- Capsule holder/stand**
- Tray

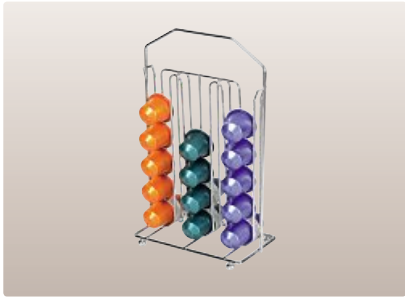
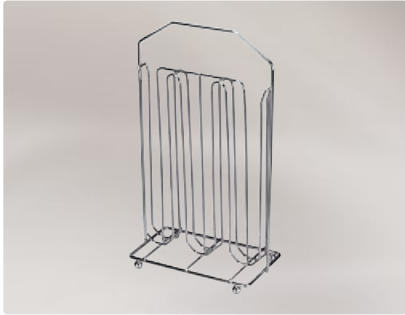

"Donatore" Coffee Capsule Stand for Nespresso, 36 capsules, silver matt

Material	Metal
Max. Capsule Capacity	36
Depth	8.5 cm
Height	25 cm
Width	15.3 cm
Colour	Silver / Matt

- 3 wire holders that each hold up to 12 capsules
- High-quality chrome plating

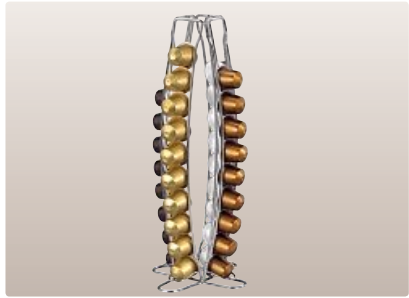

"Torre" Coffee Capsule Stand for Nespresso, 40 capsules, silver

Material	Metal
Max. Capsule Capacity	40
Depth	15 cm
Height	36.6 cm
Width	15 cm
Colour	Silver

- 4 wire holders that each hold up to 10 capsules
- High-quality chrome plating





"Tornado" Coffee Capsule Stand for Nespresso, 30 capsules, silver

Material	Metal
Max. Capsule Capacity	30
Depth	10 cm
Height	37,5 cm
Width	17 cm
Colour	Silver Chrome-Plated

- 2 wire holders that each hold up to 15 capsules
- High-quality chrome plating

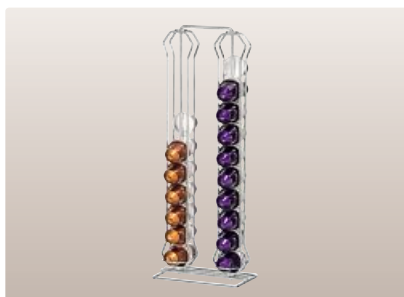

"Rullo" Coffee Capsule Rack for Nespresso, chrome-plated (silver)

Material	Metal
Max. Capsule Capacity	40
Depth	8,5 cm
Height	39,8 cm
Width	14,5 cm
Colour	Silver Chrome-Plated

- Suitable for 40 Nespresso capsules
- 2 rotatable wire holders that each hold up to 20 capsules
- Extremely compact due to the flat, sleek design
- High-quality chrome plating



"Terrazzo" Capsule Stand for Nespresso, silver

Material	Metal
Max. Capsule Capacity	80
Depth	11 cm
Height	28,8 cm
Width	11 cm
Colour	Silver

- Rotating stand for 40 Nespresso capsules
- The capsules hang decoratively outside the capsule stand, and the varieties are easy to identify through their various colours
- Inside, the capsule stand offers space for four additional Nespresso bars - 80 capsules can therefore be stored altogether



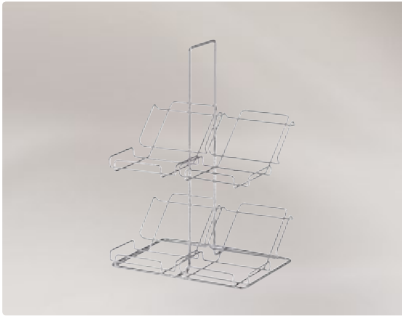

"Divano" Coffee Capsule Stand for Nespresso System Packaging, silver

Material	Metal
Max. Capsule Capacity	40
Depth	33 cm
Height	17,50 cm
Width	23,30 cm
Colour	Silver Chrome-Plated

- Rotating stand for 40 Nespresso capsules
- The capsules hang decoratively outside the capsule stand, and the varieties are easy to identify through their various colours
- Inside, the capsule stand offers space for four additional Nespresso bars - 80 capsules can therefore be stored altogether



"Acrilico" Coffee Capsule Stand for Nespresso, 40 capsules, transparent

Material	Metal
Max. Capsule Capacity	40
Depth	36,8 cm
Height	4 cm
Width	16,6 cm
Colour	Transparent

- 4 compartments that each hold up to 10 capsules
- Easy to mount on a wall or in a cupboard

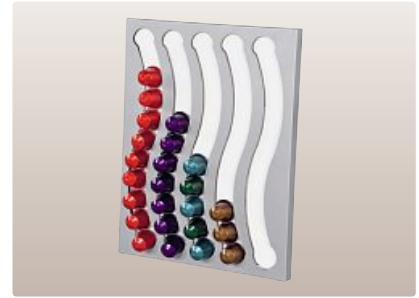
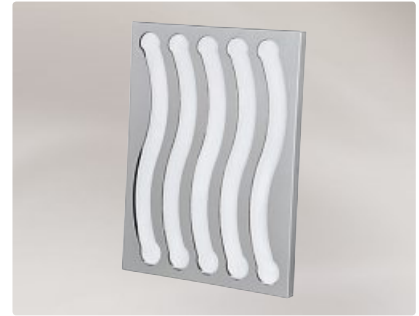

"Pendolare III" Coffee Capsule Rack for Nespresso 50, matt silver

Material	Metal
Max. Capsule Capacity	50
Depth	2 cm
Height	38 cm
Width	28,5 cm
Colour	Silver / Matt

- Capsules are simply placed in the top of the holder and removed from the bottom, so they are automatically used according to their purchase date
- Beautifully designed, elegant wall holder with curved storage slots
- High-quality metal surface and white rear panel made of metal
- Fits 5 x 10 capsules, so 5 different varieties are always at hand without having to search
- Simple to mount on a wall or in a cupboard



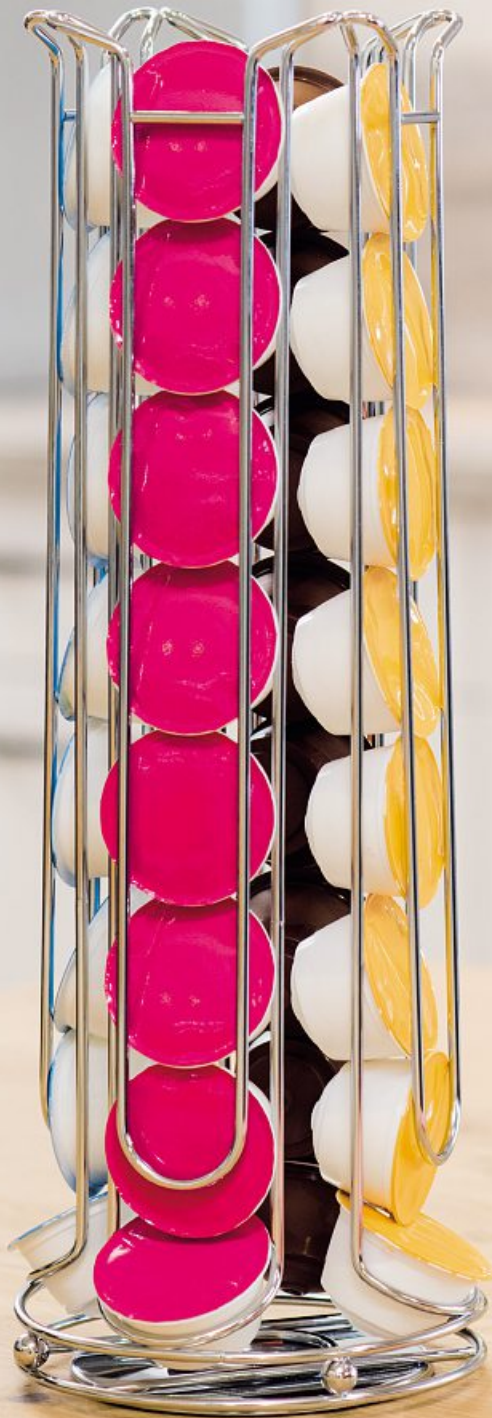

for
DolceGusto



Item No. 111103

"Torre II" Coffee Capsule Stand

For neatly storing and sorting
different types of coffee capsules
For up to 32 capsules

Dishes	Storage & Presentation	Preparation	Machine Accessories
--------	------------------------	-------------	---------------------

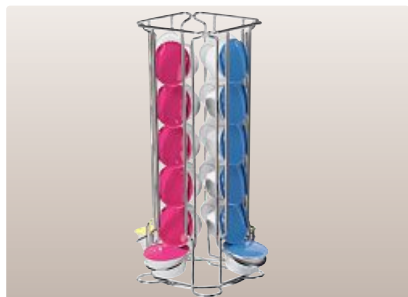

"Colonna" Coffee Capsule Stand for Dolce Gusto, 24 capsules, silver

Material	Metal
Max. Capsule Capacity	24
Depth	15.7 cm
Height	33 cm
Width	15.7 cm
Colour	Silver Chrome-Plated

- 4 wire holders that each hold up to 6 capsules (24 capsules altogether)
- High-quality chrome plating, therefore durable and easy to clean
- With a size of 33 x 17.5 x 17.5 cm (H/D/W) the capsule stand is very compact and a highlight in every kitchen



"Rondello" Coffee Capsule Stand for Dolce Gusto, silver chrome

Material	Metal
Max. Capsule Capacity	32
Depth	13 cm
Height	41 cm
Width	13 cm
Colour	Silver Chrome-Plated

- Rotating capsule stand that holds up to 32 Dolce Gusto capsules
- 8 wire holders that each hold up to 4 capsules

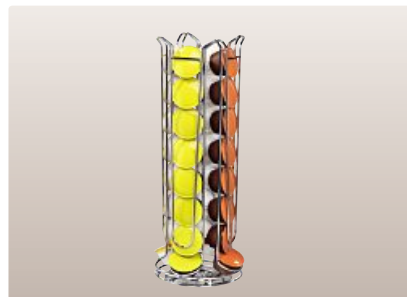

"Torre II" Coffee Capsule Stand for Dolce Gusto, 32 capsules, silver

Material	Metal
Max. Capsule Capacity	32
Depth	15.5 cm
Height	42 cm
Width	15 cm
Colour	Silver

- 4 wire holders that each hold up to 8 capsules (32 capsules altogether)
- High-quality chrome plating, therefore durable and easy to clean
- With a size of 42 x 15.5 x 15 cm (H/D/W) the capsule stand is very compact and a highlight in every kitchen



111190

4 047443 253262



111074

4 047443 047663



111103

4 047443 073990

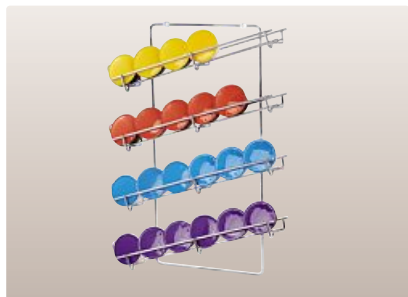

"Diagonal" Coffee Capsule Stand for Dolce Gusto, 24 capsules, silver

Material	Metal
Max. Capsule Capacity	24
Depth	41 cm
Height	6 cm
Width	31 cm
Colour	Silver Chrome-Plated

- 4 wire holders that each hold up to 6 capsules
- High-quality chrome plating
- Easy to mount on a wall or in a cupboard

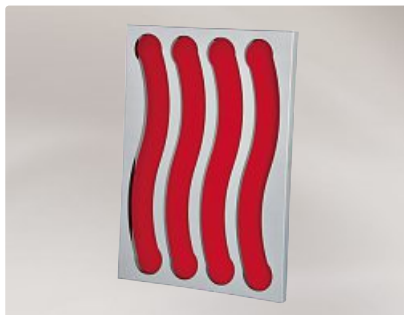

"Pendolare III" Coffee Capsule Rack for Dolce Gusto 32, matt silver

Material	Metal
Max. Capsule Capacity	32
Depth	2 cm
Height	45.5 cm
Width	31.8 cm
Colour	Silver / Matt

- Capsules are simply placed in the top of the holder and removed from the bottom, so they are automatically used according to their purchase date
- Beautifully designed, elegant wall holder with curved storage slots
- High-quality metal surface and coloured rear panel made of metal
- Fits 4 x 8 capsules, so 4 different varieties are always at hand without having to search
- Simple to mount on a wall or in a cupboard



"Compatto" Coffee Capsule Stand for Tassimo, 64 capsules, silver

Material	Metal
Max. Capsule Capacity	64
Depth	19.5 cm
Height	26.9 cm
Width	19.5 cm
Colour	Silver

- Simply insert the 8 open Tassimo boxes, the packaging itself forms the removal system
- No more tediously filling the capsules individually
- The different colours of the individual boxes makes it even easier to find what you want



Coffee & Tea

Dishes

Storage & Presentation

Preparation

Machine Accessories



"Rondello" Coffee Capsule Stand for 48 Tassimo Capsules, silver chrome

Material	Metal
Max. Capsule Capacity	48
Depth	16 cm
Height	29.5 cm
Width	16 cm
Colour	Silver Chrome-Plated

- Rotating capsule holder for 48 Tassimo capsules
- 6 wire holders that each hold up to 8 capsules

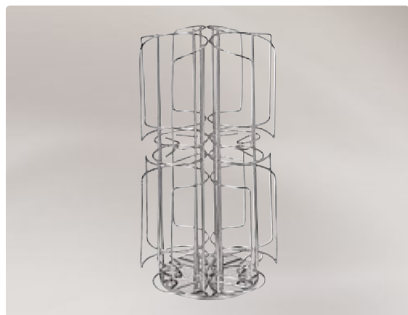

"Rondello" Coffee Capsule Stand for 64 Tassimo Capsules, stainless steel

Material	Metal
Max. Capsule Capacity	64
Depth	18 cm
Height	31 cm
Width	18 cm
Colour	Silver

- Rotating capsule holder for up to 64 Tassimo capsules
- 8 wire holders that each hold up to 8 capsules



"Rondelino" Coffee Capsule Stand for Tassimo Capsules, chrome-pl. (silver)

Material	Metal
Max. Capsule Capacity	40
Depth	19 cm
Height	19 cm
Width	19 cm
Colour	Silver Chrome-Plated

- Rotating holder for up to 40 standard Tassimo coffee capsules, divided in 4 wire holders: 10 (15 mm high) or 6 (30 mm high) per wire holder
- The high opening on the shaft where the capsules are taken off makes the stand suitable for milk capsules (30 mm high)
- The capsules can be inserted in the corner or in the spaces in between as all 4 slots can easily be accessed thanks to the swivel base
- With the low height of 19 cm a maximum of storage capacity is achieved with minimal dimensions - ideal for small kitchens



111070

4 047443 044129



111170

4 047443 163028



111181

4 047443 191335

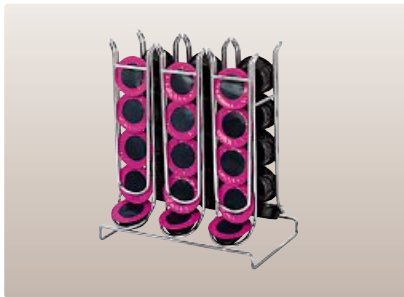

"Muro" Coffee Capsule Rack for Lavazza/Tchibo/Tea Lounge, chrome-plated (silver)

Material	Metal
Max. Capsule Capacity	30
Depth	12 cm
Height	23.5 cm
Width	19 cm
Colour	Silver Chrome-Plated

- Suitable for 30 Lavazza and Tchibo capsules
- 6 wire holders that each hold up to 5 capsules
- High-quality chrome plating

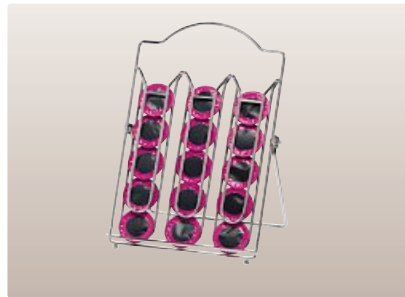

"Muro" Coffee Capsule Rack for Lavazza/Tchibo/Tea Lounge, folding

Material	Metal
Max. Capsule Capacity	15
Depth	16.5 cm
Height	31.5 cm
Width	19.5 cm
Colour	Silver Chrome-Plated

- Suitable for 15 Lavazza and Tchibo capsules
- 3 wire holders that each hold up to 5 capsules
- Can be mounted on the wall or can stand alone
- High-quality chrome plating



"Razzo" Coffee Capsule Rack for Expressi and Tchibo 32, silver chrome plat.

Material	Metal
Max. Capsule Capacity	32
Depth	16 cm
Height	39.6 cm
Width	16 cm
Colour	Silver Chrome-Plated

- 4 wire holders that each hold up to 8 capsules (32 capsules altogether)
- High-quality chrome plating, therefore durable and easy to clean
- With a size of 39.6 x 16.0 x 16.0 cm (h/d/w) the capsule stand is very compact and a highlight in every kitchen
- Each desired capsule can be removed easily as the capsule rack is rotatable





"Torre III" Coffee Capsule Stand for Lavazza, 32 capsules

Material	Metal
Max. Capsule Capacity	32
Depth	13,5 cm
Height	35 cm
Width	13,5 cm
Colour	Silver Chrome-Plated

- Suitable for 32 Lavazza capsules
- 4 wire holders that each hold up to 8 capsules
- High-quality chrome plating
- Rotatable



Permanent Filter

Coffee & tea makers

Decorating stencils

Electronic milk frother

Mechanical milk frother

Milk jug



"Coffeeduck" Coffee Filter for Senseo classic

Suitable for	Senseo Classic
Suitable for Dishwashers	✓
Number of Pieces	2

- Allows you to choose any coffee amount or strength
- Can be used in 1 or 2-cup mode
- Creates the popular Cafe Crema (coffee foam)
- Saves money (expensive pads do not have to be bought)
- Multifunctional (suitable for use with both ground coffee as well as with paper pods)
- Has a positive environmental impact
- Easy to handle
- Long service life
- Easy to clean
- Only suitable for the following Philips models: Senseo 1, Senseo 2, HD 781ff series

111056

6	BC
140 x 230	

4 047443 037671



"Coffeeduck" Coffee Filter for Senseo new generation

Suitable for	Senseo New Generation
Suitable for Dishwashers	✓
Number of Pieces	2

- Allows you to choose any coffee amount or strength
- Can be used in 1 or 2-cup mode
- Creates the popular Cafe Crema (coffee foam)
- Saves money (expensive pads do not have to be bought)
- Multifunctional (suitable for use with both ground coffee as well as with paper pods)
- Has a positive environmental impact
- Easy to handle
- Long service life
- Easy to clean
- Only suitable for the following Philips models: Senseo 3, New Generation, HD 782ff series, HD783ff series

111057

6	BC
140 x 230	

4 047443 037688



"Coffeeduck" Coffee Filter for Senseo latte/Quadrante/Viva Café/Twist/Up

Suitable for	Senseo latte/Quadrante/Viva Café/Twist/Up
Suitable for Dishwashers	✓
Number of Pieces	2

- Allows you to choose any coffee amount or strength
- Can be used in 1 or 2-cup mode
- Creates the popular Cafe Crema (coffee foam)
- Saves money (expensive pads do not have to be bought)
- Multifunctional (suitable for use with both ground coffee as well as with paper pods)
- Has a positive environmental impact
- Easy to handle
- Long service life
- Easy to clean
- Only suitable for the following Philips models: Senseo Latte Select, Senseo Quadrante, HD 785ff-Serie, HD 786ff-Serie, Senseo Viva Cafe (HD 7826 - HD 7829 sowie HD 7835 - HD 7839)



Universal Pod Holder Insert for Senseo Classic and Aluminium Version

Suitable for	Senseo Classic and Aluminium Version
Suitable for Dishwashers	✓
Number of Pieces	6

- Universal set with a pod holder, coffee filter (suitable for long-term use) and splash protection for Philips Senseo pod machines
- The pod holder may be used for cocoa/ drinking chocolate capsules
- Including coffee filter for loose coffee powder or tea, suitable for long-term use
- Including splash protection for normal teabags
- Durable and easy to use
- Easy to rinse
- This pod holder is suitable for Senseo Classic, the aluminium version and for models with the following designation: HD7800, HD7810, HD7811, HD7812, HD7840
- Not suitable for the following Senseo machines: HD7805, HD7820, HD7822, HD7823, HD7824, HD7825, HD7826, HD7827, HD7828, HD7830, HD7835, HD7841, HD7842, HD7850, HD7852, HD7853, HD7854, HD7860, HD7862



Permanent Pad, set of 2

Suitable for	Phillips Senseo
Suitable for Dishwashers	✓
Number of Pieces	2

- Ideal replacement for single-use pads, can be refilled with coffee as often as desired
- Refillable coffee or tea pad for Philips Senseo and similarly constructed coffee machines
- Allows you to enjoy your own coffee or tea varieties and to choose the strength
- Ideal replacement for single-use pads, can be refilled with coffee or tea as often as desired
- Fine filter mesh specifically for Cafe Crema (coffee foam)
- Especially easy to open thanks to 3 holders
- Environmentally friendly (pads are not required)
- Long service life





"Coffeeduck" Espresso Capsule for Nespresso Machines

Suitable for	Nespresso
Suitable for Dishwashers	✓
Number of Pieces	3

- Reusable capsule for loose espresso coffee, can also be used as replacement for Nespresso capsules
- Allows you to enjoy your coffee varieties for good value and in an environmentally friendly way
- Suitable for Nespresso and identically constructed devices that were built since September 2010



Permanent Filter

Coffee & tea makers

Decorating stencils

Electronic milk frother

Mechanical milk frother

Milk jug



Tea/Coffee Maker, 1 litre

Tea Filter	Stainless Steel
Wireless	✓
Filling Quantity:	1 l

- For brewing fresh and flavourful coffee or tea with a press filter
- Simple to use with loose tea or coffee
- Stylish glass container
- Press filter with a finely woven stainless steel sieve
- Easy to rinse out
- Handle and lid made of heat-resistant plastic





Tea/Coffee Maker, 0.6 litre

Tea Filter	Stainless Steel
Wireless	✓
Filling Quantity:	0.6 l

- For brewing fresh and flavourful coffee or tea with a press filter
- Simple to use with loose tea or coffee
- After the brewing time has elapsed, the drink is ready to serve in the stylish glass container
- Press filter with a finely woven stainless steel sieve
- Easy to rinse out
- Handle and lid made of heat-resistant plastic



Permanent Filter

Coffee & tea makers

Decorating stencils

Electronic milk frother

Mechanical milk frother

Milk jug



Stainless Steel Decorating Stencil for Cappuccinos

Material	Stainless Steel
----------	-----------------

- Decorating stencil for shaking chocolate, cocoa, coffee or cinnamon powder onto milk foam
- Suitable for all common cappuccino, coffee, espresso and latte macchiato glasses
- 3 different motifs (heart, star and flower)
- Easy to use
- Easy to clean
- Long service life





xavax[®]



“Milchicopter” electronic milk frother

A powerful motor and a special spiral guarantee perfect milk froth

Item No. 111106

Permanent Filter

Coffee & tea makers

Decorating stencils

Electronic milk frother

Mechanical milk frother

Milk jug



"Milchicopter" Milk Frother

Height	3.7 cm
Length	20 cm
Width	2.5 cm
Power Supply	2x AA Mignon Batteries

- Milk frother for a perfect milk foam
- With soft-touch surface in trendy design, for secure and comfortable handling
- Easy to clean and operate
- Suitable for cappuccino, latte macchiato, milk shakes, cocktails or salad dressings
- Extra powerful motor and special spiral for good mixing
- 2 AA batteries required



Permanent Filter

Coffee & tea makers

Decorating stencils

Electronic milk frother

Mechanical milk frother

Milk jug



"Milk Booster" Stainless Steel Milk Frother

Material	Stainless Steel
Height	15 cm
Width	9 cm
Suitable for Dishwashers	✓

- An easy way to create milk foam for your cappuccino or latte macchiato within one minute
- Jug with a lid and a handle (polished stainless steel) as well as with a plastic frother
- Milk can directly be heated in the jug
- For all types of stoves (apart from induction cookers)
- To get a perfect milk froth, pour in 200 ml milk and reciprocate the frother
- Capacity (foam) of the jug: up to 400 ml, sufficient for about 3 cups



Permanent Filter

Coffee & tea makers

Decorating stencils

Electronic milk frother

Mechanical milk frother

Milk jug



Milk Jug, stainless steel

Capacity	400 ml
Height	15 cm
Width	9 cm
Suitable for Dishwashers	✓

- Ideal for foaming or heating milk for latte macchiato or cappuccino
- High gloss polished, stainless steel jug with a cylindrical design and a volume of 400 ml
- Pour in maximally 200 ml milk to get a perfect milk foam and foam the milk with a milk frother (00111106) until creamy
- Suitable for all types of stove, except for induction cookers



Milk supply hose

Cleaning Kit

Lubricant



Milk Hose for Fully Automatic Coffee Machines, diameter: 6 mm

Material	Silicone
Diameter (Outside)	6 mm
Diameter (inside)	3 mm

- Flexible silicone tube as a spare part for the filling of liquids for fully automatic coffee machines
- Fantastic resistance against heat and high pressure
- Extremely smooth surface inside the tube largely prevents the formation of limescale even with very hard water
- This keeps the water flow rate stable and makes cleaning easy
- 1 m piece of silicone tube that can be cut individually to the required length
- The tube is 60° Shore (therefore, it remains stable when warm), translucent and food safe



Milk Hose for Fully Automatic Coffee Machines, diameter: 10 mm

Material	Silicone
Diameter (Outside)	10 mm
Diameter (inside)	7 mm

- Flexible silicone tube as a spare part for the filling of liquids for fully automatic coffee machines
- Fantastic resistance against heat and high pressure
- Extremely smooth surface inside the tube largely prevents the formation of limescale even with very hard water
- This keeps the water flow rate stable and makes cleaning easy
- 1 m piece of silicone tube that can be cut individually to the required length
- The tube is 60° Shore (therefore, it remains stable when warm), translucent and food safe



Milk supply hose

Cleaning Kit

Lubricant

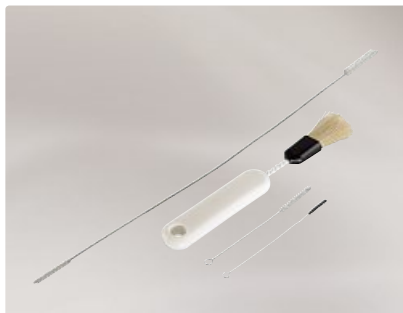

"Mini" Cleaning Kit for Fully Automatic Coffee Machines with 6 mm Milk Hose

Content	4
Recommended Use	Fully Automatic Coffee Machine
Component:	Cleaning Brush/Milk Tube Brush, 3,5 mm + 6 mm/ Nozzle Brush, 2,5 mm/ Nozzle Brush, 3,5 mm

- Special 4-part cleaning kit for fully automatic coffee machines which allow the preparation of frothy milk
- Contents of the kit: Extra long, very flexible milk hose brush (length: 33 cm, diameter: 3,5 mm and 6 mm) made of braided stainless steel wire, with two brushes
- For small, thin hoses and pipes
- Suitable for the majority of fully automatic coffee machines with milk hoses which suck in milk directly from a Tetrapack or an external container
- Cleaning brush for removing coffee powder from grinders, filter holders, brewing units, etc.
- Suitable for portafilter machines and fully automatic coffee machines
- 3,5 mm nozzle cleaning brush for cleaning nozzles, valves and outlets easily from limescale and coffee grease
- 2,5 mm nozzle cleaning brush, extra thin
- It is quite difficult to keep long milk suction hoses clean

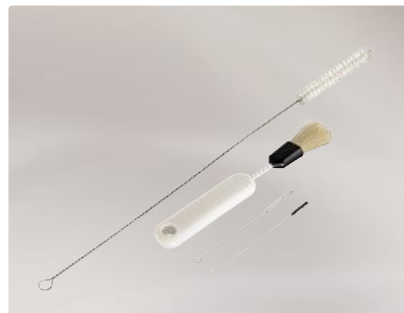

"Midi" Cleaning Kit for Fully Autom. Coffee Machines with 10 mm Milk Hose

Content	4
Recommended Use	Fully Automatic Coffee Machine
Component:	Cleaning Brush/Milk Tube Brush, 12 mm/ Nozzle Brush, 2,5 mm/ Nozzle Brush, 3,5 mm

- Special 4-part cleaning kit for fully automatic coffee machines which allow the preparation of frothy milk
- Contents of the kit: Extra long, very flexible milk hose brush (length: 33 cm, diameter: 12 mm) made of braided stainless steel wire, with brush
- For milk hoses or suction pipes of milk containers as well as for the majority of fully automatic coffee machines which suck in milk from a separate milk container
- Cleaning brush for removing coffee powder from grinders, filter holders, brewing units, etc.
- Suitable for portafilter machines and fully automatic coffee machines
- 3,5mm nozzle cleaning brush for cleaning nozzles, valves and outlets easily from limescale and coffee grease
- 2,5 mm nozzle cleaning brush, extra thin
- It is quite difficult to keep long milk suction hoses clean
- Milk contents such as milk fat, lactose (milk sugar), protein, etc. are deposited on the inside of the hoses and cannot be dissolved completely by simply rinsing the hose which results in flavourful losses



- Milk supply hose
- Cleaning Kit
- Lubricant



"OKS 1110" Multi Silicone Grease, 20 g

Content	20g
Usage	Fully Automatic Coffee Machines

- This special silicone grease can be used as sealant and lubricant in kitchens, households, bathrooms and workshops
- For brewing groups and seals in fully automatic coffee machines, milk containers, couplings, etc.
- Can also be used for lubricating and greasing kitchen appliances like universal cutters, mixers, food processors, etc.
- Also suitable for cold and hot water valves used for sanitary facilities and heating systems or in food industry
- High effectiveness due to excellent adhesion to all materials
- Neutral behaviour towards plastic materials and elastomers
- Consistent properties: does not dry out, harden or bleed
- Resistant to cold and hot water, acetone, ethanol, ethylene glycol, glycerine and methanol
- Toxicologically harmless and tested according to the German Foods, Consumer Goods and Feedstuffs Code (LFGB)
- Has no influence on taste or smell
- Food-safe
- Tested by the DVGW according to DIN EN 377
- Suitable for a temperature range from -40°C to +200°C

111177

6	BC	
90 x 230		

4 047443 173539





Household goods & Decoration

Storage	146
Baking	151
Cooking	153
Decoration	162
Household goods	171



Household goods & Decoration

Of all the things we like to do in the household, cooking, baking and decorating are some of the favorites. For proof one need only look at the many TV formats about these activities. That's why Xavax offers plenty of useful everyday assistants to make success in the kitchen even easier to achieve. Decorative signs will put it in a nutshell and bring a smile to your lips. These and other original decorative accessories top off our household range. So Xavax can not only provide practical assistance but also enable you to add your own personal touch.





All-purpose covering foil

The QR code will take you directly to our product video. There you'll see some of the countless ways our covering foil can be used.





Ornamental sign-plates

Wall signs in nostalgic styles as original decorative accessories. Their trendy vintage look makes them the perfect decoration for your home or lovely presents for any occasion.

And signs like these can sometimes get the message across more clearly and more tactfully than words.

The perfect PoS presentation

Xavax offers a variety of shop fitting elements to display the product perfectly.



Staircase display stairs

Accessory for the Tego, Ambiente and Ruppel shop fitting systems.

- Staircase display, three stairs
- Includes scanning rail

For 1 m

For 1,25 m

1000 x 335

1250 x 335

two stairs

two stairs

Item No. [00099915](#)

Item No. [00099916](#)

1000 x 390 mm

1250 x 390 mm

three stairs

three stairs

Item No. [00099902](#)

Item No. [00099903](#)



Rotating floor display

This rotating display stand can be placed quickly and easily in any well-frequented spot to attract attention.

- Can be filled on four sides
- Includes five rubber rollers (two lockable)

1880 x 575 x 419 mm

Item No. 00098542



Hanging trays

- Accessory for the Tego, Ambiente and Ruppel shop fitting systems.

For 1 m

Version with 9 trays: 1000 x 350 mm

left Item No. 00099248

right Item No. 00099248

For 1,25 m

Version with 12 trays: 1250 x 350 mm

left Item No. 00099851

right Item No. 00099852



Storage jar

Storage container set

Plastic wrap kit



**"Label Me" Storage Jar,
750 ml, 6 pieces**

Material	Glass/Plastic
Filling Quantity	750 ml
Height	14 cm

- Keeps food fresh longer, improves its shelf-life and retains the taste as well as the aroma
- Storage jar with an airtight lid for keeping the aroma
- Elegant, stylish container for the kitchen and dining table
- The jar can be labelled individually with a permanent marker or a chalk marker, it can also be marked with a label
- Food-safe

111347

6 BA



Storage container/casserole dish set

Two oven safe glass containers
Matching plastic lids with integrated silicone sealing system

Item No. 111530

Storage	Baking	Cooking	Decoration	Household goods
---------	--------	---------	------------	-----------------

Storage jar
Storage container set
Plastic wrap kit



Food Storage Box Set, 10 pieces, stand display, 36 sets

- 10-part box set for freezing, storing, heating up and serving meals
- Comprises 10 boxes with matching lids (1x 6000 ml, 1x 1700 ml, 1x 700 ml, 2x 600 ml, 2x 300 ml, 3x 150 ml)
- Transparent box with a purple lid
- Ideal for freezing and storing food
- Easy to open and close
- Non-odiferous and tasteless
- Food-safe
- Suitable for microwaves
- Suitable for dishwashers
- Suitable for a temperature range from -30°C to 110°C

		111506	
36	CB		
		4 047443 183583	



Food Storage/Oven Dish Set made of Glass, 2 pcs., round, 1650 ml, 3050 mls

- 2-part food storage/oven dish set made of glass for cooking, baking, freezing, storing, heating up and serving meals
- Consists of two glass containers (1x 1650 ml, 1x 3050 ml) with matching plastic lids in modern red transparent design and silicone seal
- Made of high-quality, ovenproof borosilicate glass
- Temperature resistance in ovens: up to 400°C
- Dishes can be transferred directly from a freezer to an oven for baking or to a microwave for defrosting and reheating
- Can also be used as a trendy dish for serving food, prevents the need to transfer to additional containers in between
- Waterproof and airtight silicone sealing system integrated in the lid, keeps food fresh longer
- Thanks to a special valve, the container is easy to open and close
- The containers can be stacked in each other for space saving storage
- Non-odiferous and tasteless, food-safe
- Easy to clean under running water or in the dishwasher

		111530	
4	CB		
		4 047443 253712	

Storage	Baking	Cooking	Decoration	Household goods
---------	--------	---------	------------	-----------------



Food Storage/Oven Dish Set made of Glass, 2 pcs., angular, 1500 ml, 3050 ml

- 2-part food storage/oven dish set made of glass for cooking, baking, freezing, storing, heating up and serving meals
- Consists of two glass containers (1x 1500 ml, 1x 3050 ml) with matching plastic lids in modern red transparent design and silicone seal
- Made of high-quality, ovenproof borosilicate glass
- Temperature resistance in ovens: up to 400°C
- Dishes can be transferred directly from a freezer to an oven for baking or to a microwave for defrosting and reheating
- Can also be used as a trendy dish for serving food, prevents the need to transfer to additional containers in between
- Waterproof and airtight silicone sealing system integrated in the lid, keeps food fresh longer
- Thanks to a special valve, the container is easy to open and close
- The containers can be stacked in each other for space saving storage
- Non-odiferous and tasteless, food-safe
- Easy to clean under running water or in the dishwasher



Storage jar

Storage container set

Plastic wrap kit



Cling Film Set made of Silicone, transparent, 20x20cm, 15x15cm, 10x10cm

- 3-part, reusable set of cling films made of silicone, for preserving the freshness and for wrapping food
- Comprises three square films (20 x 20 cm, 15 x 15 cm, 10 x 10 cm) that can be used in refrigerators, freezers or microwaves
- Due to its high elasticity the film perfectly clings to glasses, plates, bowls, pots and pans
- Ideal for covering chopped fruits or vegetables
- Allows waterproof and airtight closing
- The suitable film can easily be selected from the set depending on the size of the container
- Thanks to the transparent design the contents can be identified immediately
- Also usable as non-slip base
- For opening tightly closed glasses and bottles more easily
- Can be used in temperatures ranging from -40°C to +180°C
- Easy to clean under running water or in the dishwasher



Lighting
Coffee & Tea
Household goods & Decoration
Small household appliances
Cleaning & Care
Energy & Technology
Accessories for household appliances



**Cling Film Set made of Silicone,
3 pcs.**

For packaging and protecting food
Reusable and easy to clean

Item No. 111538

Baking tin

Kitchen utensil set

Baking set



"Bundt Cake" Microwave Baking Tin

Material	Polypropylene (PP)
Border Height	7 cm
Width	24 cm

- Mould for quickly baking cakes in a microwave oven
- Time-saving preparation within few minutes
- Ideal for short-term visits or for making a cake time and again
- Plastic mould with an attractive bundt cake design
- Easy to clean under running water or in the dishwasher
- Height: 7cm
- Diameter: 24cm

111529

8 CB

4 047443 246349

Storage

Baking

Cooking

Decoration

Household goods

Baking tin

Kitchen utensil set

Baking set



Baking Set, 8 parts

- Component: Measuring Jug/Measuring Spoon/Mixing Bowl
- Baking set comprising a mixing bowl (2.8 litres), a measuring jug (1 litre) and various measuring spoons:
- Practical rubber ring (trendy colour) on the bottom of the bowl for a firm grip
- Measuring jug with a rubber handle for a secure hold
- Six different measuring spoons for quickly measuring ingredients:
 1. 125 ml = 1/2 cup
 2. 100 ml
 3. 50 ml
 4. 1 tablespoon
 5. 1 teaspoon
 6. 1 pinch
- The measuring spoons can also be used for arranging food; when not in use, they can easily be stored in a space efficient manner
- All components of the set can easily be cleaned under running water or in the dishwasher



- Cutting board**
- Salad spinner
- Bread knife
- Knife set
- Oven glove
- Pot coaster set
- Lid

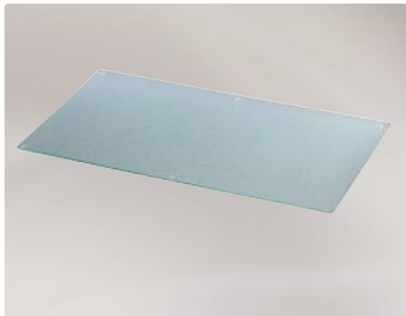

Glass Cutting Board, clear, 52 x 30 cm

Depth	30 cm
Height	1.2 cm
Width	52 cm

- For cutting, preparing and serving food as well as for protecting kitchen surfaces
- Heat-resistant chopping board made of tempered, nearly unbreakable glass
- Cut, scratch and shock resistant
- Does not take on smells, spots or liquids
- Polished edges and non-slip plastic feet
- Enlargens the work surface (can comfortably be used above the sink unit or the hot plates)
- Dishwasher safe
- Can also be used as serving plate for warm or cold meals



Glass Cutting Plate, 2 pieces, "Wine" design, 30 x 20 cm, 35 x 25 cm

- Tempered safety glass with an appealing design
- Shock-resistant board with polished edges
- Odourless and tasteless
- Non-slip PVC feet for a firm grip
- Dishwasher-safe



- Cutting board
- Salad spinner**
- Bread knife
- Knife set
- Oven glove
- Pot coaster set
- Lid



Salad Spinner

Diameter	24 cm
Height	13.5 cm
Suitable for Dishwashers	✓

- Salad spinner with a crank mechanism, a removable sieve insert and a pourer
- The salad remains crunchy and fresh
- The plastic dish is also suitable for preparing and serving food
- Pourer covered with lid, therefore hygienic storage without air exchange
- Easy to clean under running water or in the dishwasher

111353

4	BA	
4 047443 167088		

- Cutting board
- Salad spinner
- Bread knife**
- Knife set
- Oven glove
- Pot coaster set
- Lid

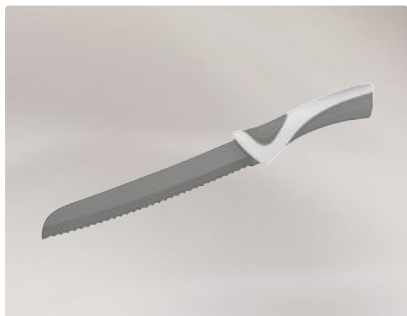

Bread Knife, grey

Material (Blade)	Stainless Steel
Type of Blade	Serrated Blade
Length Blade	19 cm
Colour	Grey/White

- Long, serrated blade for slicing wide loaves; gives you perfect slices of bread without tearing while minimizing the crumbs
- The specially shaped plastic handle provides a secure grip which makes cutting through thick crusts easy
- Blade made of hardened steel with colour coating
- Attractive grey/white design, an eyecatcher in every kitchen

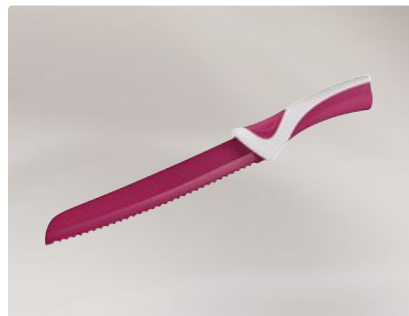

Bread Knife, red

Material (Blade)	Stainless Steel
Type of Blade	Serrated Blade
Length Blade	19 cm
Colour	Red/White

- Long, serrated blade for slicing wide loaves; gives you perfect slices of bread without tearing while minimizing the crumbs
- The specially shaped plastic handle provides a secure grip which makes cutting through thick crusts easy
- Blade made of hardened steel with colour coating
- Attractive red/white design, an eyecatcher in every kitchen



Lighting

Coffee & Tea

Household goods & Decoration

Small household appliances

Cleaning & Care

Energy & Technology

Accessories for household appliances

Storage	Baking	Cooking	Decoration	Household goods
---------	--------	---------	------------	-----------------

Cutting board
Salad spinner
Bread knife
Knife set
Oven glove
Pot coaster set
Lid

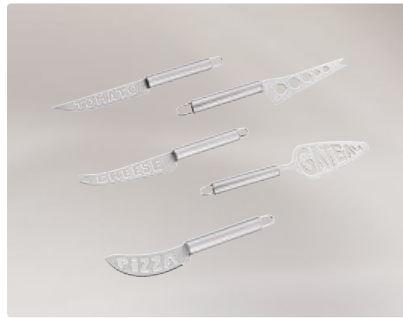

Party Knife Set, stainless steel, 5 pieces

- Knives with an original design for parties, dinners or coffee breaks
- 2 cheese knives for cutting soft and semi-hard cheese
- 1 pizza knife for cutting tartes flambées, pancakes and bread or confectionery
- 1 vegetable knife for cutting up vegetables like tomatoes, cucumbers, carrots and fruits
- 1 cake server for cutting and serving a piece of cake or pie
- Handle with sturdy suspension eye so that the knives can compactly and clearly be stored on kitchen hooks
- This knife set is an ideal gift
- Decoration and cutting tool in one - great for every buffet

		111540
10	CB	
4 047443 290250		



Kitchen Knife Set, stainless steel, 6 parts

- Kitchen knife set for cooking, baking and grilling
- 6-part set consisting of:
 - Bread knife (size of the knife: 33 cm, blade length: 19,0 cm): long, serrated blade for slicing wide loaves; gives you perfect slices of bread without tearing while minimizing the crumbs
 - Chef's knife (size of the knife: 33,5 cm, blade length: 19,5 cm): wide blade, universally usable for chopping and cutting meat, vegetables, salads and spices
 - All-purpose knife (size of the knife: 23,5 cm, blade length: 12,5 cm), facilitates cleaning, cutting and peeling fruits and small pieces of meat
 - Vegetable knife (size of the knife: 20,5 cm, blade length: 9,5 cm), ideal for peeling and chopping vegetables, especially e.g. for onions, carrots, peppers or garlic
 - Butcher's steel (size of the knife: 29,5 cm, blade length: 18,5 cm): for keeping knives sharp
 - Kitchen scissors with an integrated bottle opener (size of the scissors: 18,5 cm, blade length: 6 cm): versatile and ideal for cutting herbs, strings, cords, wax paper, packthreads and more
- The special black coating of the grip prevents fingerprints, streaks, etc. (would be the case e.g. with stainless steel)

		111541
15	CB	
4 047443 288431		



xavax[®]



Item No. 111541

Kitchen Knife Set, stainless steel

Bread knife, chef's knife, utility knife,
paring knife, sharpening steel
and kitchen scissors
Special non-slip sheathing

Storage	Baking	Cooking	Decoration	Household goods
---------	--------	---------	------------	-----------------



Kitchen Knife Set, 4 parts, with knife block, green/white

- Kitchen knife set including a knife block for cooking, baking and grilling
- Bread knife (size of the knife: 33 cm, blade length: 20.0 cm): long, serrated blade for slicing wide loaves; gives you perfect slices of bread without tearing while minimizing the crumbs
- Chef's knife (size of the knife: 33.5 cm, blade length: 19.5 cm): wide blade, universally usable for chopping and cutting meat, vegetables, salads and spices
- All-purpose knife (size of the knife: 23.5 cm, blade length: 12.5 cm), facilitates cleaning, cutting and peeling fruits and small pieces of meat
- Vegetable knife (size of the knife: 19.5 cm, blade length: 8.5 cm), ideal for peeling and chopping vegetables, especially e.g. for onions, carrots, peppers or garlic
- Each of the four knives features a specially shaped plastic handle that provides a secure grip
- Knife block made of sturdy plastic with a removable bristle insert
- Bristle insert is especially gentle on the knives
- The fibre insert holds knives in any position
 - no slots required
- Easy to clean, the insert can be removed in its plastic housing and cleaned under running water
- Stubborn dirt can easily be removed from the special mat surface of the knife block with a moist cloth

		111543
12	CB	
4 047443 290267		

Cutting board
Salad spinner
Bread knife
Knife set
Oven glove
Pot coaster set
Lid



"Frog" Silicone Oven Glove

Material	Silicone
Colour	Red/White

- Oven glove made of heat-resistant silicone, protects your hands from burning on contact with hot pots, pans, baking trays, etc.
- Ideal for transporting warm containers like pots, bowls and oven dishes
- Oven glove with a funky frog design: the frog's large mouth offers a non-slip grip and provides a secure hold on pot handles
- For both left and right handed use
- Easy to clean under running water or in the dishwasher

		111528
36	CB	
4 047443 246332		

- Cutting board
- Salad spinner
- Bread knife
- Knife set
- Oven glove
- Pot coaster set**
- Lid

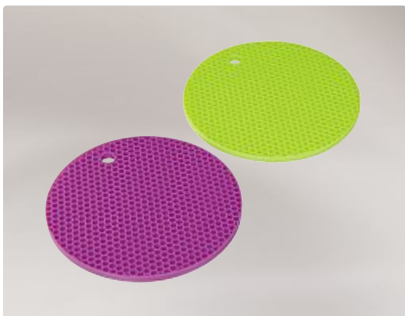

Set of Pot Coasters

Component	Pot Coaster, green/Pot Coaster, purple
-----------	--

- Pot coaster made of silicone, protects tables and worktops
- Suitable as a coaster for pots and pans, can also be used as a pot cloth
- Non-slip silicone surface for a secure hold and firm grip on hot pots, pans and oven dishes as well as for easily opening lids of glasses and bottles
- Integrated suspension eye for compact storage
- Round, robust and heat-resistant silicone coaster with a diameter of 18 cm
- Easy to clean under running water or in the dishwasher

		111527
50	CB	

Lighting

Coffee & Tea

Household goods & Decoration

Small household appliances

Cleaning & Care

Energy & Technology

Accessories for household appliances



for ø
16/18/20 cm



for ø
24/26/28 cm



Universal Lid for Pots and Pans

With silicone ring for pots and pans
Versatile transparent glass cover for keeping
an eye on your cooking

Item No. 111544 /111545

- Cutting board
- Salad spinner
- Bread knife
- Knife set
- Oven glove
- Pot coaster set
- Lid**



Universal Lid with Steam Vent for Pots and Pans, 16, 18, 20 cm, glass

Material	Glass/Silicone
Height	5,5 cm

- Glas lid with steam hole and silicone ring for pots and pans from 16 to 20 cm
- Versatile transparent glass lid for full view cooking
- Steam release vent minimizes the risk of liquids boiling over
- Thanks to the special design of the lid it replaces three lid sizes and can be used for pots as well as for pans with a diameter of 16, 18 or 20 cm
- Can easily and compactly be stored in a kitchen cupboard
- The elastic silicone border "nestles" against the respective border profile and prevents excessive heat loss
- Glas lid contains all splashes
- Easy to clean under running water or in the dishwasher

111544

18	BA	
4 047443 295637		



Universal Lid with Steam Vent for Pots and Pans, 24, 26, 28 cm, glass

Material	Glass/Silicone
Height	6,5 cm

- Glas lid with steam hole and silicone ring for pots and pans from 24 to 28 cm
- Versatile transparent glass lid for full view cooking
- Steam release vent minimizes the risk of liquids boiling over
- Thanks to the special design of the lid it replaces three lid sizes and can be used for pots as well as for pans with a diameter of 24, 26 or 28 cm
- Can easily and compactly be stored in a kitchen cupboard
- The elastic silicone border "nestles" against the respective border profile and prevents excessive heat loss
- Glas lid contains all splashes
- Easy to clean under running water or in the dishwasher

111545

12	BA	
4 047443 295644		

Decorative Sign



"Sitzpinkeln only" Decoration Sign, 25 x 25 cm

Mounting	Wire Hoop
Material	Metal
Width x Depth x Height	25 x 0,05 x 25 cm

- Modern decoration for your home
- Trendy vintage look
- Great gift idea
- Cool saying for at home, your family and friends



"We're open" Decoration Sign, 25 x 25 cm

Mounting	Wire Hoop
Material	Metal
Width x Depth x Height	25 x 0,05 x 25 cm

- Modern decoration for your home
- Trendy vintage look
- Great gift idea
- Cool saying for at home, your family and friends



"We're closed" Decoration Sign, 25 x 25 cm

Mounting	Wire Hoop
Material	Metal
Width x Depth x Height	25 x 0,05 x 25 cm

- Modern decoration for your home
- Trendy vintage look
- Great gift idea
- Cool saying for at home, your family and friends



"Morgenmuffel" Decoration Sign, 25 x 25 cm

Mounting	integrated
Material	Metal
Width x Depth x Height	25 x 0,05 x 25 cm

- Modern decoration for your home
- Trendy vintage look
- Great gift idea
- Cool saying for at home, your family and friends





26x35 cm



25 x 25 cm



39 x 14 cm



Ornamental signplates with a vintage look

Always the right saying for your home or as a gift for family and friends

Over 40 designs

Item No. 136320/136329/136332

Storage	Baking	Cooking	Decoration	Household goods
---------	--------	---------	------------	-----------------



"Niveau" Decoration Sign, 25 x 25 cm

Mounting	integrated
Material	Metal
Width x Depth x Height	25 x 0,05 x 25 cm

- Modern decoration for your home
- Trendy vintage look
- Great gift idea
- Cool saying for at home, your family and friends



"Sekt" Decoration Sign, 25 x 25 cm

Mounting	integrated
Material	Metal
Width x Depth x Height	25 x 0,05 x 25 cm

- Modern decoration for your home
- Trendy vintage look
- Great gift idea
- Cool saying for at home, your family and friends



"Shit Happens" Decoration Sign, 25 x 25 cm

Mounting	integrated
Material	Metal
Width x Depth x Height	25 x 0,05 x 25 cm

- Modern decoration for your home
- Trendy vintage look
- Great gift idea
- Cool saying for at home, your family and friends



"Drinks" Decoration Sign, 25 x 25 cm

Mounting	integrated
Material	Metal
Width x Depth x Height	25 x 0,05 x 25 cm

- Modern decoration for your home
- Trendy vintage look
- Great gift idea
- Cool saying for at home, your family and friends



"With you" Decoration Sign, 25 x 25 cm

Mounting	integrated
Material	Metal
Width x Depth x Height	25 x 0,05 x 25 cm

- Modern decoration for your home
- Trendy vintage look
- Great gift idea
- Cool saying for at home, your family and friends



"Reason" Decoration Sign, 25 x 25 cm

Mounting	integrated
Material	Metal
Width x Depth x Height	25 x 0,05 x 25 cm

- Modern decoration for your home
- Trendy vintage look
- Great gift idea
- Cool saying for at home, your family and friends





"Coffee Shop" Decoration Sign, 25 x 25 cm

Mounting	integrated
Material	Metal
Width x Depth x Height	25 x 0,05 x 25 cm

- Modern decoration for your home
- Trendy vintage look
- Great gift idea
- Cool saying for at home, your family and friends



"Hot Dogs" Decoration Sign, 25 x 25 cm

Mounting	integrated
Material	Metal
Width x Depth x Height	25 x 0,05 x 25 cm

- Modern decoration for your home
- Trendy vintage look
- Great gift idea
- Cool saying for at home, your family and friends



"Love" Decoration Sign, 26 x 35 cm

Mounting	integrated
Material	Metal
Width x Depth x Height	26 x 0,05 x 35 cm

- Modern decoration for your home
- Trendy vintage look
- Great gift idea
- Cool saying for at home, your family and friends



"Drink Coffee" Decoration Sign, 26 x 35 cm

Mounting	integrated
Material	Metal
Width x Depth x Height	26 x 0,05 x 35 cm

- Modern decoration for your home
- Trendy vintage look
- Great gift idea
- Cool saying for at home, your family and friends

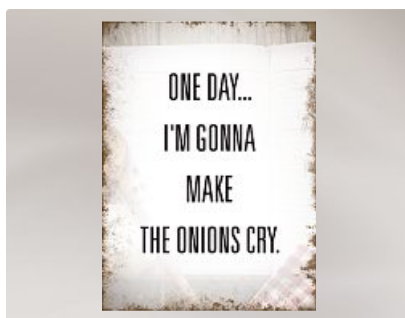

"One Day" Decoration Sign, 26 x 35 cm

Mounting	integrated
Material	Metal
Width x Depth x Height	26 x 0,05 x 35 cm

- Modern decoration for your home
- Trendy vintage look
- Great gift idea
- Cool saying for at home, your family and friends



"Cold Beer" Decoration Sign, 26 x 35 cm

Mounting	integrated
Material	Metal
Width x Depth x Height	26 x 0,05 x 35 cm

- Modern decoration for your home
- Trendy vintage look
- Great gift idea
- Cool saying for at home, your family and friends



Household goods & Decoration

Storage	Baking	Cooking	Decoration	Household goods
---------	--------	---------	------------	-----------------



"Cupcake" Decoration Sign, 26 x 35 cm

Mounting	integrated
Material	Metal
Width x Depth x Height	26 x 0,05 x 35 cm

- Modern decoration for your home
- Trendy vintage look
- Great gift idea
- Cool saying for at home, your family and friends



"Barbecue" Decoration Sign, 26 x 35 cm

Mounting	integrated
Material	Metal
Width x Depth x Height	26 x 0,05 x 35 cm

- Modern decoration for your home
- Trendy vintage look
- Great gift idea
- Cool saying for at home, your family and friends



"House Rules" Decoration Sign, 26 x 35 cm

Mounting	integrated
Material	Metal
Width x Depth x Height	26 x 0,05 x 35 cm

- Modern decoration for your home
- Trendy vintage look
- Great gift idea
- Cool saying for at home, your family and friends



"Pets" Decoration Sign, 26 x 35 cm

Mounting	integrated
Material	Metal
Width x Depth x Height	26 x 0,05 x 35 cm

- Modern decoration for your home
- Trendy vintage look
- Great gift idea
- Cool saying for at home, your family and friends



"Dream" Decoration Sign, 26 x 35 cm

Mounting	integrated
Material	Metal
Width x Depth x Height	26 x 0,05 x 35 cm

- Modern decoration for your home
- Trendy vintage look
- Great gift idea
- Cool saying for at home, your family and friends



"Dusche" Decoration Sign, 26 x 35 cm

Mounting	integrated
Material	Metal
Width x Depth x Height	26 x 0,05 x 35 cm

- Modern decoration for your home
- Trendy vintage look
- Great gift idea
- Cool saying for at home, your family and friends





"Laugh" Decoration Sign, 26 x 35 cm

Mounting	integrated
Material	Metal
Width x Depth x Height	26 x 0,05 x 35 cm

- Modern decoration for your home
- Trendy vintage look
- Great gift idea
- Cool saying for at home, your family and friends



"Welcome" Decoration Sign, 39 x 14 cm

Mounting	Wire Hoop
Material	Metal
Width x Depth x Height	39 x 0,05 x 14 cm

- Modern decoration for your home
- Trendy vintage look
- Great gift idea
- Cool saying for at home, your family and friends



"Sterneküche" Decoration Sign, 39 x 14 cm

Mounting	Wire Hoop
Material	Metal
Width x Depth x Height	39 x 0,05 x 14 cm

- Modern decoration for your home
- Trendy vintage look
- Great gift idea
- Cool saying for at home, your family and friends



"Wellness Lounge" Decoration Sign, 39 x 14 cm

Mounting	Wire Hoop
Material	Metal
Width x Depth x Height	39 x 0,05 x 14 cm

- Modern decoration for your home
- Trendy vintage look
- Great gift idea
- Cool saying for at home, your family and friends

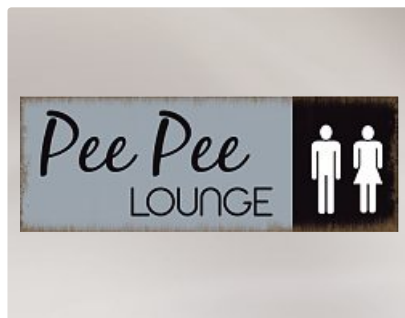

"Pee Pee Lounge" Decoration Sign, 39 x 14 cm

Mounting	Wire Hoop
Material	Metal
Width x Depth x Height	39 x 0,05 x 14 cm

- Modern decoration for your home
- Trendy vintage look
- Great gift idea
- Cool saying for at home, your family and friends



"Dog" Decoration Sign, 39 x 14 cm

Mounting	integrated
Material	Metal
Width x Depth x Height	39 x 0,05 x 14 cm

- Modern decoration for your home
- Trendy vintage look
- Great gift idea
- Cool saying for at home, your family and friends



Household goods & Decoration

Storage

Baking

Cooking

Decoration

Household goods



**"Cat" Decoration Sign,
39 x 14 cm**

Mounting	Wire Hoop
Material	Metal
Width x Depth x Height	39 x 0,05 x 14 cm

- Modern decoration for your home
- Trendy vintage look
- Great gift idea
- Cool saying for at home, your family and friends



**"Kiss" Decoration Sign,
39 x 14 cm**

Mounting	integrated
Material	Metal
Width x Depth x Height	39 x 0,05 x 14 cm

- Modern decoration for your home
- Trendy vintage look
- Great gift idea
- Cool saying for at home, your family and friends



**"Liebe" Decoration Sign,
39 x 14 cm**

Mounting	integrated
Material	Metal
Width x Depth x Height	39 x 0,05 x 14 cm

- Modern decoration for your home
- Trendy vintage look
- Great gift idea
- Cool saying for at home, your family and friends



**"Bon Appétit" Decoration Sign,
39 x 14 cm**

Mounting	integrated
Material	Metal
Width x Depth x Height	39 x 0,05 x 14 cm

- Modern decoration for your home
- Trendy vintage look
- Great gift idea
- Cool saying for at home, your family and friends

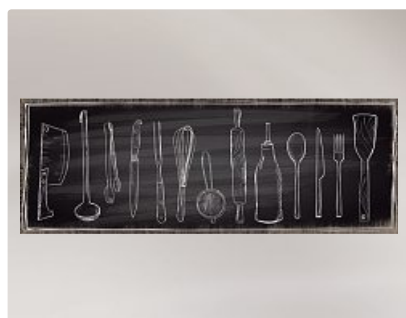

**"Küche" Decoration Sign,
39 x 14 cm**

Mounting	integrated
Material	Metal
Width x Depth x Height	39 x 0,05 x 14 cm

- Modern decoration for your home
- Trendy vintage look
- Great gift idea
- Cool saying for at home, your family and friends



**"Chill Out" Decoration Sign,
39 x 14 cm**

Mounting	integrated
Material	Metal
Width x Depth x Height	39 x 0,05 x 14 cm

- Modern decoration for your home
- Trendy vintage look
- Great gift idea
- Cool saying for at home, your family and friends



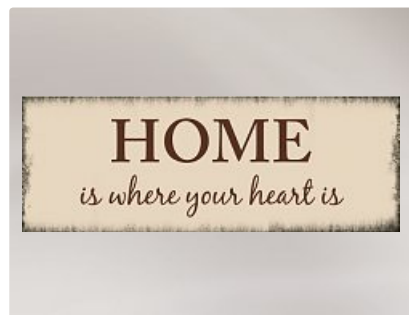

"Home" Decoration Sign, 39 x 14 cm

Mounting	integrated
Material	Metal
Width x Depth x Height	39 x 0,05 x 14 cm

- Modern decoration for your home
- Trendy vintage look
- Great gift idea
- Cool saying for at home, your family and friends

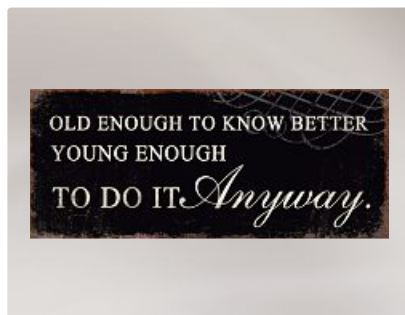

"Anyway" Decoration Sign, 39 x 14 cm

Mounting	integrated
Material	Metal
Width x Depth x Height	39 x 0,05 x 14 cm

- Modern decoration for your home
- Trendy vintage look
- Great gift idea
- Cool saying for at home, your family and friends



"Desperate Housecats" Decoration Sign, 39 x 14 cm

Mounting	integrated
Material	Metal
Width x Depth x Height	39 x 0,05 x 14 cm

- Modern decoration for your home
- Trendy vintage look
- Great gift idea
- Cool saying for at home, your family and friends



"Smile" Decoration Sign, 39 x 14 cm

Mounting	integrated
Material	Metal
Width x Depth x Height	39 x 0,05 x 14 cm

- Modern decoration for your home
- Trendy vintage look
- Great gift idea
- Cool saying for at home, your family and friends



"Time" Decoration Sign, 39 x 14 cm

Mounting	integrated
Material	Metal
Width x Depth x Height	39 x 0,05 x 14 cm

- Modern decoration for your home
- Trendy vintage look
- Great gift idea
- Cool saying for at home, your family and friends

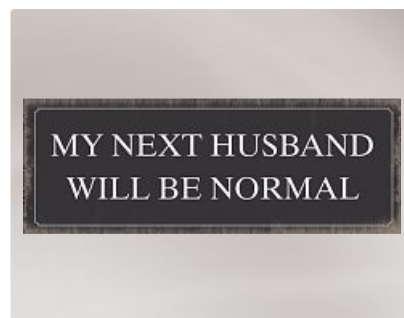

"Next Husband" Decoration Sign, 39 x 14 cm

Mounting	integrated
Material	Metal
Width x Depth x Height	39 x 0,05 x 14 cm

- Modern decoration for your home
- Trendy vintage look
- Great gift idea
- Cool saying for at home, your family and friends



Storage	Baking	Cooking	Decoration	Household goods
---------	--------	---------	------------	-----------------



"Happy Girls" Decoration Sign, 39 x 14 cm

Mounting	integrated
Material	Metal
Width x Depth x Height	39 x 0,05 x 14 cm

- Modern decoration for your home
- Trendy vintage look
- Great gift idea
- Cool saying for at home, your family and friends



"Happy Girls" Decoration Sign, 35 x 26 cm

Mounting	integrated
Material	Metal
Width x Depth x Height	35 x 0,05 x 26 cm

- Modern decoration for your home
- Trendy vintage look
- Great gift idea
- Cool saying for at home, your family and friends

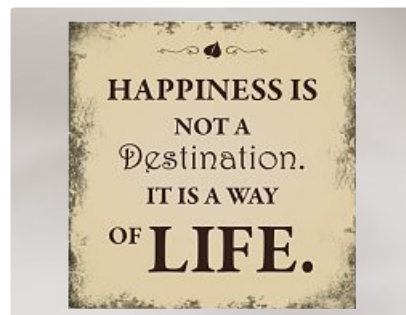

"Life" Decoration Sign, 25 x 25 cm

Mounting	integrated
Material	Metal
Width x Depth x Height	25 x 0,05 x 25 cm

- Modern decoration for your home
- Trendy vintage look
- Great gift idea
- Cool saying for at home, your family and friends



"Calendar" Decoration Sign, 39 x 14 cm

Mounting	integrated
Material	Metal
Width x Depth x Height	39 x 0,05 x 14 cm

- Modern decoration for your home
- Trendy vintage look
- Great gift idea
- Cool saying for at home, your family and friends



Multi-functional lighter

Wall hook



Multifunction Lighter, fixed, 12 pieces in a display box

Refillable	✓
Length	28.5 cm

- The amount of gas is continuously adjustable which allows you to select between a large or small flame
- A window helps you control the remaining amount of gas
- Can be refilled when empty
- Suspension device for optimum, space-saving storage
- Lock slider (child safety feature) protects against incorrect operation
- 4 different colours: black, red, yellow and blue

111327

48	BC	4 047443 150653
95 x 320		



Multifunction Lighter, flexible, 12 pieces in a display box

Refillable	✓
Length	28.5 cm

- The amount of gas is continuously adjustable which allows you to select between a large or small flame
- A window helps you control the remaining amount of gas
- Can be refilled when empty
- Flexible neck for more safety when making a fire
- Lock slider (child safety feature) protects against incorrect operation
- 4 different colours: black, red, silver and blue

111328

48	BC	4 047443 150660
115 x 320		

Lighting

Coffee & Tea

Household goods & Decoration

Small household appliances

Cleaning & Care

Energy & Technology

Accessories for household appliances

Multi-functional lighter

Wall hook



Adhesive Pads with Metal Hook, reusable, 2 pieces

Material	Metal/Plastic
----------	---------------

- Ideal for towels, tea towels, oven cloths and oven gloves
- The adhesive pad grips firmly on all smooth surfaces
- Easy to attach, no drilling required
- Reusable, can be removed without leaving any residue

		111535	
6	BC		
90 x 180		4	047443 268044



Adhesive Pads with Plastic Hook, reusable, 5 pieces

Material	Plastic
----------	---------

- Ideal for towels, tea towels, oven cloths and oven gloves
- The adhesive pad grips firmly on all smooth surfaces
- Easy to attach, no drilling required
- Reusable, can be removed without leaving any residue

		111536	
6	CB		
90 x 180		4	047443 268051



xavax[®]



Adhesive Pads with Plastic Hook

For your kitchen and bathroom
Self-adhesive and reusable

Item No. 111536



Small household appliances

Kitchen	178
Bathroom	184

Small household appliances

Pleasing forms, modern designs and choice materials combined with perfect utility: that's the standard we demand of our line of small household appliances, which consists mainly of bathroom and kitchen scales as well as kitchen timers. High-quality and high-precision sensors and clockwork form a unit with break-proof safety glass or genuine wood. Thus an everyday object becomes a useful and eye-catching decorative accessory.



Item No. 00104983



“As far as measurement precision goes, the winner is simply not to be beaten. The total deviation across all test series combined (!) was only three grams.”



Item No. 00113956



“Not only eye-catching, but also a very functional scale: The Philina satisfies completely on all counts, including in its workmanship, which is very good despite its low price tag.”





Lighting

Coffee & Tea

Household goods & Decoration

Small household appliances

Cleaning & Care

Energy & Technology

Accessories for household appliances



Kitchen scales

Measuring jug scales

Kitchen timer



"Milla" Kitchen Scales

Division	1 g
Height	3,55 cm
Length	19 cm
Maximum Load Carrying Capacity	5000 g
Width	15 cm
Battery Type	CR2032
Number of Batteries	1

- Glass scraper in first equipment quality, specially developed for glass ceramic hobs
- Also removes colour or residues of stickers on glass, tiles, etc.
- When not in use, the blade can easily be retracted (protective function)
- Ergonomically shaped grip, can be hung up
- The blade can easily be replaced (replacement blades item no.: 00111096)
- Dimensions of the metal housing: 138 x 46 mm



"Philina" Kitchen Scales, bamboo

Division	1 g
Height	1,5 cm
Length	23 cm
Maximum Load Carrying Capacity	5000 g
Width	18 cm
Battery Type	CR2032
Number of Batteries	2

- Weighing surface made of bamboo wood
- Accurate weight control thanks to high-precision sensor technology
- Easy to use thanks to two buttons (unit, on/tare)
- Automatic switch-off
- Display for low battery level and overload warning
- Large, easy to read LCD display with blue backlight
- Also displays ml, oz and lb



Kitchen

Bathroom



"Wanda" Kitchen Scales

Division	1 g
Height	25,0 cm
Length	15,0 cm
Maximum Load Carrying Capacity	3000 g
Width	5,0 cm
Battery Type	Micro AAA
Number of Batteries	3

- Especially suited for wall mounting
- Folding arm for optimal storage of the scales on the wall
- Weighing possible in the practical weighing bowl that can be placed on the weighing surface or directly on the weighing surface that is made of high-quality safety glass
- Continuously indicates the time in standby mode after automatic switch-off after 30 seconds
- Easy to read LCD display with four places, easy to use with four buttons (unit, tare, set, on/off)
- Indicates the weight in grammes or kilogrammes
- Display for low battery level and overload warning
- With timer function
- High-precision sensor technology
- Can also be used as a stand-alone device



"Lia" Kitchen Scales

Division	1 g
Height	2,8 cm
Length	20 cm
Maximum Load Carrying Capacity	5000 g
Width	16 cm
Battery Type	Micro AAA
Number of Batteries	2

- Practical and stylish scales
- Precise weight check due to high-precision sensor technology
- Easy to use thanks to two buttons (unit, on/tare)
- Easy to read display with four places
- Allows you to measure in grammes and millilitres, with differentiation between milk and water
- Display for low battery level and overload warning
- Automatic switch-off



"Lenia" Kitchen Scales

Division	1 g
Height	2,8 cm
Length	20 cm
Maximum Load Carrying Capacity	5000 g
Width	16 cm
Battery Type	Micro AAA
Number of Batteries	2

- Practical and stylish scales
- Precise weight check due to high-precision sensor technology
- Easy to use thanks to two buttons (unit, on/tare)
- Easy to read display with four places
- Allows you to measure in grammes and millilitres, with differentiation between milk and water
- Display for low battery level and overload warning
- Automatic switch-off



Kitchen scales

Measuring jug scales

Kitchen timer



Measuring Cup Scale

Division	1 g
Material	Plastic
Depth	24 cm
Height	15.1 cm
Maximum Load Carrying Capacity	3000 g
Width	14 cm
Battery Type	CR2450
Energy	Battery
Number of Batteries	1
Colour	White

- Easy-to-read LC display indicating weight in 1g increments
- Automatic switch-off
- Tare function
- Measuring jug removable and suitable for dishwashers
- Measurement scale (jug): ml, oz and cups
- Different measurement units can be set: g, ml, oz, floz and cups
- Low battery warning



- Kitchen scales

- Measuring jug scales

- Kitchen timer**



Egg Timer, stainless steel

Egg Timer, stainless steel

Maximum Time Interval	59 min
Width	55 mm
Height	75 mm

Maximum Time Interval	59 min
Width	65 mm
Height	45 mm

- Simply twist the timer and set to the required time (up to 59 minutes)
- Loud signal tone when the set time is up
- 1 minute graduations up to the 15th minute
- Sturdy housing for placing the timer directly on the worktop in your kitchen
- High-quality stainless steel housing

- Simply twist the timer and set to the required time (up to 59 minutes)
- Loud signal tone when the set time is up
- 1 minute graduations
- Sturdy housing for placing the timer directly on the worktop in your kitchen
- Can also be attached to all magnetic surfaces (e.g. to refrigerator doors) by means of the magnet on the back
- Plastic housing with a high-quality stainless steel surface

095302

12	CB	
4 047443 192547		

095303

12	CB	
4 047443 192554		



"Countdown" Kitchen Timer, digital

Kitchen timer with timer and stopwatch functions

Can be attached with magnet, clip, built-in hanger or stand

Item No. 111319



"Enano" Kitchen Timer

Maximum Time Interval	60 min
Width	65 mm
Height	95 mm

- Simply twist the timer and set to the required time (up to 60 minutes)
- Loud signal tone when the set time is up
- 1 minute graduations
- Sturdy housing for placing the timer directly on the worktop in your kitchen
- High-quality metal housing
- Stylish design with trendy colours

"Countdown" Kitchen Timer, digital, black

Maximum Time Interval	99,59 min
Width	15 mm
Height	70 mm
Battery Type	Micro AAA
Number of Batteries	1

- Up to 99 minutes and 59 seconds can be programmed thanks to 3 buttons; with a start/stop button
- Loud signal tone
- Large, 4-digit display with XX:XX format
- Sturdy housing, can be mounted in many positions, e.g. by means of a magnet, clip, built-in hanger and stand

"Time(r) Machine" Kitchen Timer

Maximum Time Interval	99,59 min
Width	70 mm
Height	21 mm
Battery Type	Micro AAA
Number of Batteries	1

- Programmable up to 99 minutes and 59 seconds with 3 buttons, with start/stop button
- Loud signal tone
- 4-digit, large display with display area XX:XX
- Stable housing can be mounted in many positions, for example by magnet, built-in hanger and stand

111358

24 CB

4 047443 185723

White 111319

12 CB

4 047443 192578

Black 095304

12 CB

4 047443 192561

113957

10 BC

92 x 157

4 047443 182203

Bathroom scales

Body fat weighing scales



"Melina" Bathroom Scales

"Melissa" Bathroom Scales

Height	1.8 cm
Length	30 cm
Maximum Load Carrying Capacity	150 kg
Width	30 cm
Battery Type	CR2032
Number of Batteries	1

Height	1.8 cm
Length	30 cm
Maximum Load Carrying Capacity	150 kg
Width	30 cm
Battery Type	CR2032
Number of Batteries	1

- Easy to read, four digit LCD display
- Weighing surface made of high-quality safety glass
- Unit button for easily changing the units of weight (kg, lb, st:lb)
- Automatic switch on/off - weighs immediately upon stepping on the scales
- Display for low battery level and overload warning
- Ultra slim

- Auto-on activation
- Large LCD display
- High-precision sensor technology
- Automatic switch-off
- Display for low battery level and overload warning
- Ultra-slim
- Safety glass





"Florina" Bathroom Scales

"Florina" Bathroom Scales

"Ronda" Bathroom Scales

Height	1.8 cm
Length	30 cm
Maximum Load Carrying Capacity	150 kg
Width	30 cm
Battery Type	CR2032
Number of Batteries	1

Height	1.8 cm
Length	30 cm
Maximum Load Carrying Capacity	150 kg
Width	30 cm
Battery Type	CR2032
Number of Batteries	1

Height	2.7 cm
Length	33,0 cm
Maximum Load Carrying Capacity	150 kg
Width	33,0 cm
Battery Type	CR2032
Number of Batteries	1

- Easy to read, four digit LCD display
- Weighing surface made of high-quality safety glass
- Electronic scales for weighing persons with a body weight of up to 150 kilogrammes
- Unit button for easily changing the units of weight (kg, lb, st:lb)
- Automatic switch on/off - weighs immediately upon stepping on the scales
- Display for low battery level and overload warning
- Ultra slim
- Scales with a slim, black design and white flower line drawing

- Easy to read, four digit LCD display
- Weighing surface made of high-quality safety glass
- Electronic scales for weighing persons with a body weight of up to 150 kilogrammes
- Unit button for easily changing the units of weight (kg, lb, st:lb)
- Automatic switch on/off - weighs immediately upon stepping on the scales
- Display for low battery level and overload warning
- Ultra slim
- Scales with a slim, black design and white flower line drawing

- Very precise weight control thanks to high-precision sensor technology
- Scales with a pleasing, round design
- Weighing surface made of high-quality safety glass
- Easy-to-read, four-digit LCD display (format: XXX.X)
- Button on the bottom side of the scales for easily changing the units of weight (kg, lb, st:lb)
- Automatic switch on/off: weighs immediately upon stepping on the scales
- Display for low battery level and overload warning





"Ronda" Bathroom Scales

Very precise weight control thanks to high-precision sensor technology
Weighing surface made of high-quality safety glass

Item No. 095308

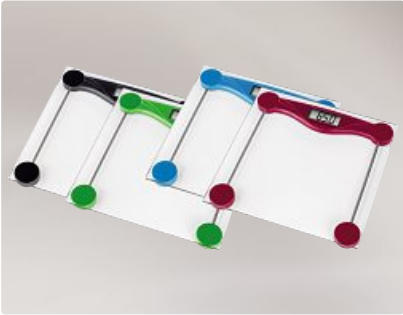

"Melania" Bathroom Scales, 12 pieces, assorted colours

Height	2.4 cm
Length	28 cm
Maximum Load Carrying Capacity	180 kg
Width	28 cm
Battery Type	CR2032
Number of Batteries	1

- Very precise weight control thanks to high-precision sensor technology
- Weighing surface made of high-quality safety glass
- Easy-to-read, four-digit LCD display (format: XXX.X)
- Button on the bottom side of the scales for easily changing the units of weight (kg, lb, st:lb)
- Automatic switch on/off: weighs immediately upon stepping on the scales
- Display for low battery level and overload warning



"Varinja" Bathroom Scales

Height	4.6 cm
Length	34.4 cm
Maximum Load Carrying Capacity	150 kg
Width	34.4 cm
Battery Type	CR2032
Number of Batteries	1

- Scales with a pleasing colourful design
- Weighing surface made of high-quality safety glass
- Easy-to-read, four-digit LCD display (format: XXX.X)
- Button on the bottom side of the scales for easily changing the units of weight (kg, lb, st:lb)
- Automatic switch on/off - weighs immediately upon stepping on the scales
- Display for low battery level and overload warning



"Naila" Bathroom Scales

Height	4.6 cm
Length	34.4 cm
Maximum Load Carrying Capacity	150 kg
Width	34.4 cm
Battery Type	CR2032
Number of Batteries	1

- Scales with a pleasing colourful design
- Weighing surface made of high-quality safety glass
- Easy-to-read, four-digit LCD display (format: XXX.X)
- Button on the bottom side of the scales for easily changing the units of weight (kg, lb, st:lb)
- Automatic switch on/off - weighs immediately upon stepping on the scales
- Display for low battery level and overload warning





"Naila" Bathroom Scales

Scales with a pleasing colourful design
Weighing surface made of high-quality
safety glass

Item No. 095312



"Picta" Bathroom Scales

"Rosie" Bathroom Scales, bamboo

"Ramona" Bathroom Scales, bamboo

Height	2,0 cm
Length	30 cm
Maximum Load Carrying Capacity	150 kg
Width	30 cm
Battery Type	CR2032
Number of Batteries	1

Height	3,2 cm
Length	30 cm
Maximum Load Carrying Capacity	150 kg
Width	30 cm
Battery Type	CR2032
Number of Batteries	2

Height	3,2 cm
Length	30 cm
Maximum Load Carrying Capacity	150 kg
Width	30 cm
Battery Type	CR2032
Number of Batteries	2

- Very precise weight control thanks to high-precision sensor technology
- Picture frame integrated in the weighing surface
- Weighing surface made of high-quality safety glass
- Paper insert so that you can easily change the design of the scales or for inserting your own photos, etc.
- Easy-to-read, four-digit LCD display
- Time display in standby mode
- Button on the bottom side of the scales for easily changing the units of weight (kg, lb, st:lb)
- Automatic switch on/off: weighs immediately upon stepping on the scales
- Display for low battery level and overload warning

- With blue backlight
- Auto-on activation
- High-precision four sensor technology
- Large LCD display
- Automatic switch-off
- Display for low battery level and overload display

- Made of stylish, dark bamboo
- With blue backlight
- Auto-on activation
- Large LCD display
- High-precision four sensor technology
- Automatic switch-off
- Display for low battery level and overload warning



Bathroom scales

Body fat weighing scales

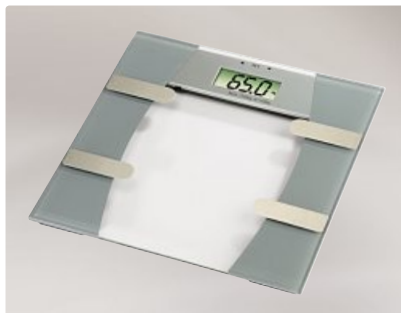

"Amelie" Body Fat Scales

Depth	30 cm
Height	1,95 cm
Maximum Load Carrying Capacity	150 kg
Width	30 cm
Battery Type	CR2032
Number of Batteries	2

- Data memory for 10 people
- Auto-on activation
- High-precision, four sensor technology
- Large LCD display
- Ultra-slim
- Graduation: 0.1 % for body fat, body water level
- Automatic switch-off
- Automatically returns to "zero"
- Safety glass
- Overload display
- Display for low battery level

"Amelie" Body Fat Scales

Depth	30 cm
Height	1,95 cm
Maximum Load Carrying Capacity	150 kg
Width	30 cm
Battery Type	CR2032
Number of Batteries	2

- Data memory for 10 people
- Safety glass
- Activated with a tap of the foot
- Large LCD display
- Ultra-slim
- High-precision, four sensor technology
- Body fat and water level given to the nearest 0.1%
- Automatic switch-off
- Automatically returns to "zero"
- Battery capacity display (for low batteries)
- Overload display





"Infra" Body Fat Scales

Depth	35,0 cm
Height	4,0 cm
Maximum Load Carrying Capacity	150 kg
Width	35,0 cm
Battery Type	9V E-Block/Micro AAA
Number of Batteries	3

- Very precise weight control thanks to high-precision sensor technology
- Scales with a pleasing, round design
- Weighing surface made of high-quality safety glass
- Maximum load indication of 150 kg
- Data memory for 10 persons
- Communication between the display and scales via infrared (a red LED is illuminated during the weighing process)
- Easy-to-read, four-digit LCD display
- The scales can also be used for measuring the body weight; in this case the sensing electrodes on the display are not "contacted"
- SET button for easily changing the units of weight (kilogramme and pounds)
- When changing the units of measurement, the size is automatically changed as well (metres/inches)
- Automatic switch on/off: weighs immediately upon stepping on the scales
- Display for low battery level and overload warning (allows you to control the scales' function in the display)

095307

6	CB
---	----

Lighting

Coffee & Tea

Household goods & Decoration

Small household appliances

Cleaning & Care

Energy & Technology

Accessories for household appliances



xavax

**Premium-
Entkalker**



**100 %
Garantie***

für die optimale
Entkalkung aller
Markengeräte wie:

AEG, Bosch, Braun,
DeLonghi, Franke,
Jura, Krups, Melitta,
Nespresso, Philips,
Saeco, Severin,
Siemens, WMF, ...

Made in Germany

00110732

Cleaning & Care

Coffee machines	196
Washing up	198
Kitchen cleaning	202
Washing & ironing	206
Descaler	210
Special cleaner	213

Cleaning & Care

In any household, there are many surfaces, machines and devices to be cleaned and cared for day after day. A single all-purpose cleaner just can't satisfy every demand. Washing machines, automatic coffee-makers, refrigerators and worktops all require their own care. That's why Xavax offers a comprehensive line of specialised products tailored to the requirements of each individual household appliance and material. Effective cleaning and maximum protection are the focus. This will extend service lifetimes and preserve the visual appearance.





Safety first

The cleaners are equipped with childproof locks to protect children at the Point of Sale and at home. In the worst-case scenario, every product has an central emergency telephone number printed on it. Calls to this number will be automatically forwarded to the poison control centre. Quick help is guaranteed.



Top quality made in Europe

Environmentally-friendly manufacturing and short delivery distances, optimal and efficient cleaning while being as gentle on materials as possible - these are the strengths of the Xavax cleaning and care products made in Europe



Distributed by Hama GmbH & Co KG
Dresdner Str. 9
86653 Monheim/Bayern, GERMANY
Tel.: +49 (0)9091 502-6400
www.xavax.eu



Secondary promotional placements generate additional sales

A newly purchased appliance should last as long as possible. So, clearly, it is a good idea to offer the perfect care products to the customer at the same time. Ideally, they should be placed right next to the appliance! That's why most Xavax articles are delivered in a practical shop display. Our marketing motto is "unpack - set up - sell".



Household Cleaner



"Coffee Clean" Special Cleaner for Fully Automatic Coffee Machines

Content	250 ml
Suitable for	Coffee Machine
Usage	Fully Automatic Coffee Machines

- Specially designed for cleaning high-quality coffee machines
- Cleans and protects lastingly everything which comes into direct contact with coffee: brewing device, container for coffee grounds, drip tray, sieves, coffee and water spout, cup tray
- Even coffee grease can easily be removed with the special cleaning formula
- The lubricating grease which is important for the mobility of the brewing device is not affected and is preserved
- Highly effective cleaning substances dissolve dirt and ensure hygiene and shine inside the coffee machine
- Simply spray the cleaner to the components which should be cleaned, let the product act and rinse off with clear water or wipe off with a moist cloth
- Due to the high-quality spray head, the cleaning solution is optimally distributed on the dirty components and dirt is easily flushed away
- For perfectly hygienic coffee



Cleaner for Milk Froth Brewing Devices

Content	500 ml
Suitable for	Coffee Machine
Usage	Milk Froth Nozzles

- Cleaned brewing devices provide for perfect foam with best taste
- During the cleaning process, all fat and protein deposits, which develop when cappuccinos or milky coffees are made, are removed
- The lines and nozzles are cleaned lastingly and remain longer clean and pure
- Flavourful losses by old deposits are avoided
- Contains high-quality additives for highly effective cleaning and protection
- Application in cold or hot condition possible
- With child safety catch and sealed cap





Degreaser/Cleaning Tablets for Automatic Coffee Machines, 10 pieces

Content	10 x 2,5g
Suitable for	Coffee Machine
Usage	Fully Automatic Coffee Machines

- When coffee is brewed, coffee fat forms, in particular at high pressure and temperature
- Coffee fat has to be removed from fully automatic and semi-automatic coffee machines, espresso and automatic coffee pad machines to keep the devices functioning
- Brew groups, filter carriers, drip bowls are hygienically cleaned
- Taste losses with the coffee are avoided
- Also suitable for cleaning thermos flasks and teapots



111889

6	BC
90 x 155	

4 047443 266897

Household cleaner

Dishwasher salt

Cleaning cloth



**Cleaner for Dishwashers
fresh scent, 250 ml**

Content	250 ml
Suitable for	Dishwasher
Usage	Dishwasher

- Removes deposits such as limescale, grease and scraps of food from the interior, the hoses and the valves
- Descales heating rods to optimise the heat output and save energy
- Freshens by leaving behind a fresh scent and ensures your washing machine is clean
- Longer warm-up times with higher electricity costs
- Low reliability with high costs



**2-Phase Professional Tablets for
Dishwashers**

Content	160 x 18g
Suitable for	Dishwasher
Usage	Dishwasher

- Ideal for encrusted and very greasy dishes
- Simple to use, easily removes stubborn dirt
- Dissolve limescale well
- Easily dissolve tea and coffee residues
- Produce little foam
- Also suitable for intensive programmes
- Protect sensitive decorations and patterns
- Dry and clean storage as the tablets come in a high-quality bucket with a "first removal seal"



- Household cleaner
- Dishwasher salt
- Cleaning cloth



Spülan Salt, compact

Content	2000 g
---------	--------

- Special, coarse grained evaporated salt which is suitable for all dishwashers
- Pure salt for optimal solubility
- Supports optimal effectiveness of cleaning agents like tabs or powders and gives tableware a lovely shine

110764

6	CB	
---	----	--

Coffee machines

Washing up

Kitchen cleaning

Washing & ironing

Descaler

Special cleaner

Household cleaner

Dishwasher salt

Cleaning cloth



Microfibre Cloths, 30 x 30 cm, blue/ green/yellow/red

Material	15% Polyamide/85% Polyester
Washable	Up to 30°C
Width x Length	30 x 30 cm
Colour	Blue/Green/Red/Yellow
Number	4

- Removes dust, grease and dirt
- Excellent cleaning results with moist and dry cleaning
- One extra cloth for every surface, with different textures for more hygiene
- Can be used with or without cleaning agents
- Long service life

110758

10 CB

4 047443 246462



Microfibre cloths

Optimum cleaning results with moist and dry cleaning

Art. Nr. 110758

Cleaning & Care

Coffee machines

Washing up

Kitchen cleaning

Washing & ironing

Descaler

Special cleaner

Household cleaner

Cleaning set

Scraper

Replacement blade



Glass Ceramic Cleaner, 250 ml

Content	250 ml
Suitable for	Ceremic glas-/ Induction-Hobs
Usage	Cooking Plate

- Removes stubborn grime and can be used on a daily basis
- The cleaner leaves an invisible film on the surface when rubbed dry; this makes the next cleaning process easier and gives the hob a lovely shine



Cleaning Spray for Refrigerators, 500 ml

Content	500 ml
Suitable for	Fridge and Freezer
Usage	Fridge

- Even dissolves stubborn dirt, fat deposits and traces of usage
- For interior and exterior cleaning
- Effective against bad smells, provides long lasting freshness





Stainless Steel Cleaning Spray, 300 ml

Content	300 ml
Suitable for	Universally Usable
Usage	Metal Surfaces

- Removes impurities of all kinds effectively and gently on the material
- Cleans and protects in one step
- The water-resistant film prevents new stains from forming
- Absolutely smear-free
- With long-term protection against resoiling

Household cleaner

Cleaning set

Scraper

Replacement blade



Glass-Ceramic Cleaning Kit

Content	125 ml
Recommended Use	Household
Component	Scraper, microfibre cloth, cleaner (125 ml)

- For gentle and easy cleaning as well as for care of glass ceramic hobs
- For daily care and for removing stubborn stains
- The cleaner leaves an invisible film (makes the next cleaning easier) and gives the hob a lovely shine



Household cleaner

Cleaning set

Scraper

Replacement blade



Glass Scraper for Glass Ceramic Cooker Surfaces

Material	Plastic
Safety Lock	-
Usage	For All Smooth Surfaces

- Also suitable for glass, tiles and other smooth, hard surfaces
- Removes residues of stickers, colours, soot, lime etc.
- The blade can be replaced and retracted for transport (replacement blades item no.: 00110726)

110702

6	BC	
90 x 230		

4 047443 004352



Glass Scraper for Glass Ceramic Cooker Surfaces

Material	Metal
Safety Lock	-
Usage	For All Smooth Surfaces

- High-quality glass scraper, specially developed for glass ceramic hobs
- Also suitable for removing colour or residues of stickers from glass, tiles, etc.
- When not in use, the blade can easily be retracted (protective function)
- Ergonomically shaped grip that allows the scraper to be hung up
- Blade can easily be exchanged (replacement blades: item no.: 00110726)
- Size of the metal housing: 138 x 46 mm

110753

12	BC	
92 x 230		

4 047443 015952

- Household cleaner
- Cleaning set
- Scraper
- Replacement blade**



Replacement Blades for Glass Scrapping Tool for Glass Ceramic Hobs, 5 pieces

Number of Blades	5
Usage	Ceramic Stove Top

- Replacement blades for Xavax glass scraping tool for glass ceramic hobs (item no. 00110702 and 00110753)
- Ground on both sides, thereby doubling the service life

		110726	
24	BC		
90 x 155	4		
		047443 004598	

Household cleaner

Cleaning set



Washing Machine Care Cleaner

Content	250 ml
Suitable for	Washing Machine
Usage	Washing Machine

- Also cleans parts that cannot be accessed by hand, e.g. hoses, gaps, filters, spray nozzles and the complete drum
- Optimizes the heat output of your machine and helps you save energy
- Unpleasant odours and deposits are mostly due to low temperatures (washing cycles with temperatures below 40°C) and savings programmes, regularly cleaning your washing machine prevents such things occurring
- Freshens by leaving behind a fresh scent and ensures your washing machine is clean
- Regularly cleaning your machine minimizes the risk of defects and improves the washing performance
- Every new machine is tested by the manufacturer; using this washing machine cleaner when washing with the machine for the first time removes possible test water residues

111723

12	BA	
----	----	--

4 047443 279781



Iron Water

Content	1000 ml
Suitable for	Electric Iron
Usage	Steam Iron

- Iron water that is demineralized by reverse osmosis
- Completely free from dissolved substances that may damage the iron and laundry
- No evaporation residues on the laundry
- Increases the lifetime of the iron as it takes care of the material

111888

12	BA	
----	----	--

4 047443 260970



Iron Cleaning Spray, 50 ml

Content	50 ml
Suitable for	Electric Iron
Usage	Iron

- The cleaner acts rapidly, protects and keeps the device clean for longer due to the highly efficient additives
- Suitable for aluminium, stainless steel and ceramics soleplates
- Easy to use thanks to the micro atomizer and the supplied microfibre cloth
- Ensures excellent gliding of your iron on the laundry





Item No. 111723

Washing Machine Care Cleaner

With fresh scent
Eliminates contamination and odours
caused by washing agent residues, deposits
and limescale

Household cleaner

Cleaning set



Washing Machine Care Set, descaler + cleaner

Content	250 ml
Recommended Use	Household
Component	no specifications

- Cleaner for washing machines
- Removes grease and limescale residue inside the machine
 - Cleans important parts such as heating rods, hoses, filters and spray nozzles and protects them from blockages
 - This will optimise the heat output and will save energy
 - Unpleasant odours and washing agent residues are removed
 - These residues can detrimentally affect the result of the washing cycle and could lead to expensive repairs

- Descaler for washing machines
- Dissolves already encrusted calcareous deposits on heating rods, hoses and valves
 - Optimizes the heat output and saves energy since the machine heats up faster
 - Calcareous deposits do not come any longer into the laundry, the wash result is improved
 - Protects plastic and rubber parts



Iron Cleaning Spray, 50 ml

Content	50 ml
Suitable for	Electric Iron
Usage	Steam Iron

- The cleaner acts rapidly, protects and keeps the device clean for longer due to the highly efficient additives
- Suitable for aluminium, stainless steel and ceramics soleplates
- Easy to use thanks to the micro atomizer and the supplied microfiber cloth
- Ensures excellent gliding of your iron on the laundry



Descaler



Premium Descaler for High-Quality Coffee Machines

Content	500 ml
Safety Lock	✓
Usage	Fully Automatic Coffee Machines

- Ideal for fully and semi automatic coffee machines, filter load-bearing devices and coffee pad machines
- Hot decalcification possible with a machine pressure of 15 bar (prevents the solution from foaming and damage caused by increased gas pressure)
- Also suitable for filter machines, water digesters and all the other devices and household objects which have to be descaled providing they do not have an acid-sensitive surface (e.g. in hairdresser's shops, nail salons and medical practices)
- Descaling with amidosulfonic acid does not require any reaction time. The descaler dissolves and flushes away limescale, it is odour free and neutral in taste
- The 4 high-quality additives provide for optimum corrosion protection: metal and plastic parts in the device are not attacked
- With a child safety catch and sealed cap

110732

20 BA

4 047443 004659



Universal Descaler, 500 ml

Content	500 ml
Safety Lock	✓
Usage	Universally Usable

- For water digesters, pots, shower nozzles, tap filters, irons, immersion heaters, filter coffee and tea machines etc.
- Added high-quality additives provide for corrosion protection at the metal and plastic parts
- Lime can also be removed from high-grade steel, tiles and ceramics
- With child safety catch and sealed cap

110734

20 BA

4 047443 004673



Quick Bio Descaler

Content	250 ml
Safety Lock	✓
Usage	Universally Usable

- Suitable for all tea, coffee, espresso and pad machines as well as for fully automatic coffee machines, egg boilers, kettles, immersion heaters, pots, stainless steel pans, sink units, stainless steel, chrome, ceramic, plastic surfaces, etc. which should be descaled very gently
- On the basis of citric acid which avoids flavourful losses or unpleasant odours during the decalcification process
- With a child safety catch and a sealed cap



Descaling Tablets

Content	6 x 18g
Safety Lock	-
Usage	Universally Usable

- Designed to dissolve and flush away carefully and easily already encrusted calcareous desposits (limescale)
- The pressed in tablets are a clever design for easy handling and boast an easier dosage compared to liquid descalers
- Very fast solubility



Descaler for Steam Irons, 250 ml

Content	250 ml
Safety Lock	✓
Usage	Steam Iron

- Practical ready to use solution for descaling steam irons
- Effectively descales steam irons and prevents the formation of new limescale deposits
- Special mixture for high-quality steam irons (does not endanger the inside sole of the iron)
- Applying the descaler to cold irons is unproblematic, chalky deposits do not crumb, does not lead to problems when ironing





Item No. 111768

Descaling Tablets

Highly effective descaler for all water-heating household devices such as coffeemakers, espresso machines and capsule or pod coffee machines



Washing Maschine Descaler, 250 ml

Content	250 ml
Safety Lock	✓
Usage	Washing Machines

- Dissolves already encrusted calcareous deposits on heating rods, hoses and valves
- Optimizes the heat output and saves energy since the machine heats up faster
- Calcareous deposits do not come any longer into the laundry, the wash result is improved
- Protects plastic and rubber parts

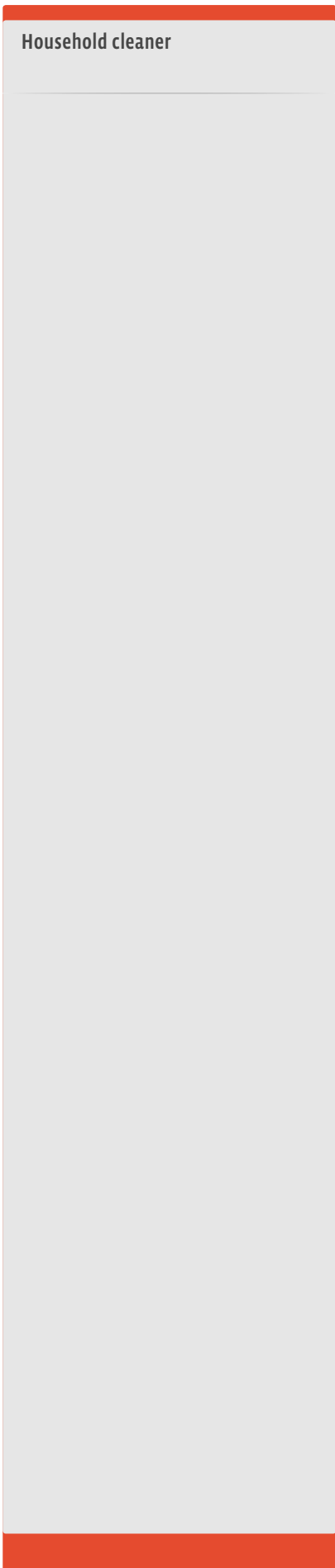

Household cleaner



Cleaner for Oral Hygiene Devices

Content	250 ml
Suitable for	Oral Irrigator and Toothbrush
Usage	Oral Hygiene Appliances

- Removes lime spots as well as mouthwashes and toothpaste residues from your hygiene products
- Regular use recommended (at least once a month) as residual moisture favours germ formation in dental water jets and on brush heads





Energy & Technology

Safety	232
Smart Home	246
Comfort	248



Energy & Technology

Increasing comfort and security in your own home: That's what the "Energy and Technology" section at Xavax is about. There you'll find mains socket adapters and heater regulators that can be controlled conveniently from your smartphone. These will simultaneously afford more cosiness in your home and help you save on energy costs. Security at home is a valuable asset. Since burglary rates have been increasing greatly, protection is becoming ever more important. HomeSafety from Xavax will protect your home quickly, easily and very effectively. And on the go, mobile alarm sirens will attract attention when you need it most.





SMART HOME

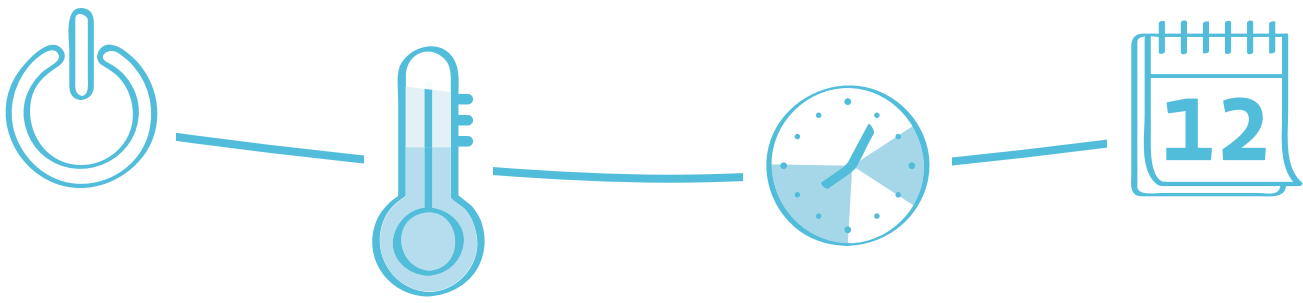

Lighting

Coffee & Tea

Household goods & Decoration

Small household appliances

Cleaning & Care

Energy & Technology

Accessories for household appliances



SAFETY

Xavax Home Safety

Every year 5.5 million burglaries are committed all over the world

The number of burglaries has risen dramatically in recent years. The numbers speak plainly: something must be done.

A matter of less than 30 seconds

As we know, opportunity makes a thief. There are some classic mistakes that positively extend an invitation. But even closed windows and doors are no obstacle for professionals if they aren't sufficiently secured.

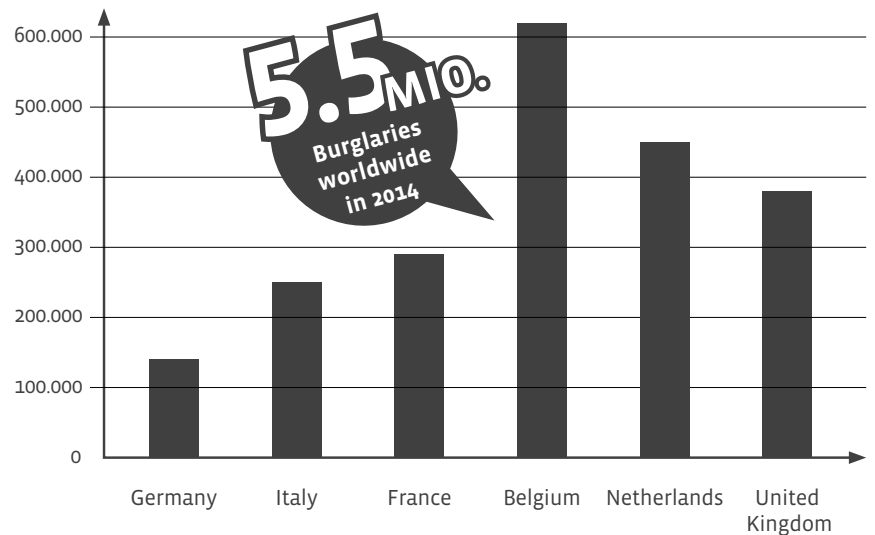

Source: EuNIC-Europe (European Information Center for Culture)

Burglary attempts aborted already after 2-5 minutes

If there's one thing a burglar doesn't have, it's time. If unanticipated obstacles arise or a disruption occurs, then the burglary attempt will stay just that: an attempt.



Protected Home

Statistics show that systematic deterrence measures and early disruption are very effective in scaring off burglars. Xavax Home Safety provides an extensive line of solutions for just that: security solutions tailored to any building. From a simple door stopper with a built-in alarm for placement behind the door to a full alarm system complete with door sensors and motion detectors (which is actually quite easy to install).

Mobile Safety is a term that describes portable alarm sirens for being out and about. In case of harassment, they make it easy to attract attention.

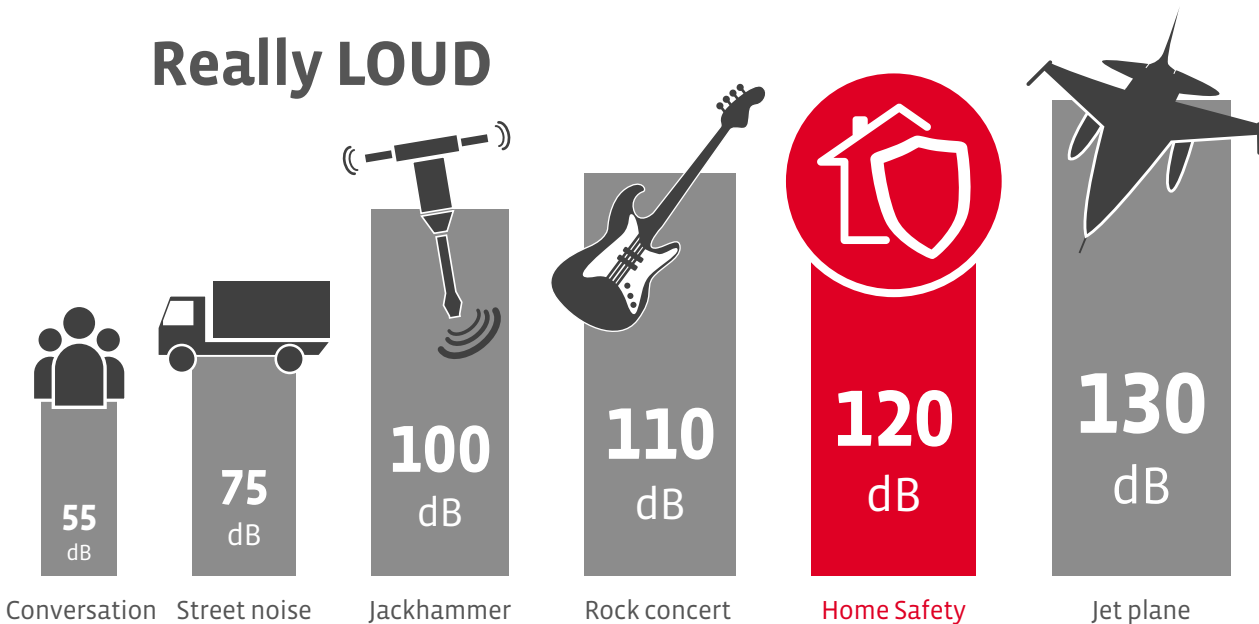

Airtight security

Effective protection from burglary demands security measures tailored to the house in question. Products from Home Safety make it child's play. They're simple and require no tools to install. They're also easy to use and basically self-explanatory. Features such as battery testing guarantee reliable functioning. And if there's one thing they all have in common, it's that they're really loud!

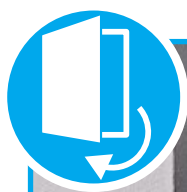

Window/ Door Sensors

By means of magnet contacts, opened doors and windows can be registered instantly and an alarm raised. Various models are available, e.g. for sliding doors or with PIN codes.



Glass Breakage Detectors and Vibration Sensors

Vibration sensors detect use of force on windows and doors immediately. Two different sensitivity pre-sets are available so that the alarm need not be triggered by normal occurrences such as gusts of wind, children playing, etc.





Motion Sensors

In the event that burglars succeed in entering the premises, motion sensors can raise the alarm. Placed centrally, they can register any movement. The advantage of installing them on the ceiling: They cannot be quickly silenced by intruders.



Dummy Security Cameras

They look totally real, and when in doubt, dodgy types will take to their heels rather than run the risk of being filmed and identified. Flashing LEDs complete the illusion. These will nip burglary attempts in the bud.

Independently operating security solutions

The front door of the apartment, a sliding door to the terrace, a large room: each situation requires its own security solution. Each of the components you'll find here does its own specialised job completely independently of all the others.

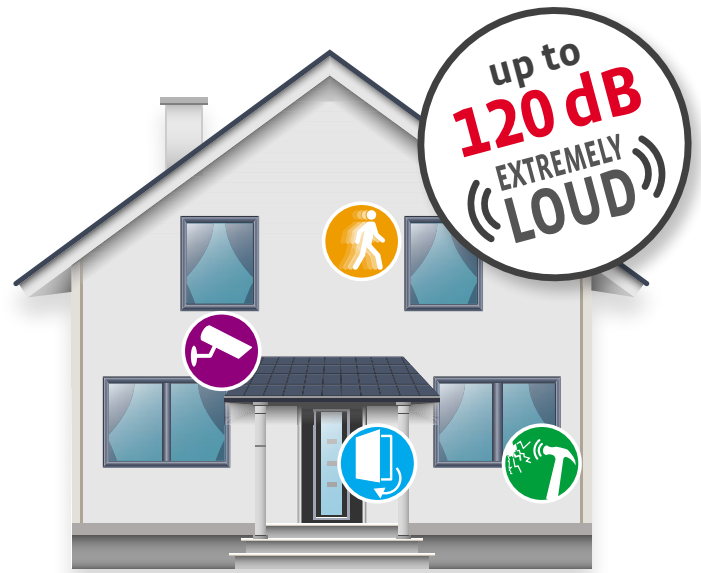

Window/ Door Sensors

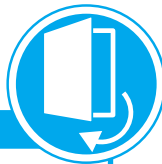

- Alarm triggered when door/window is opened
- Protection for any ingress point

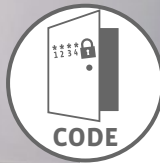

For entrance doors

00111982



For terrace/sliding doors

00111985



For tilt-&-turn windows and doors

00111986

Glass Breakage Detectors



- Alarm triggered by impacts/glass breakage
- Adjustable sensitivity (HI/LOW) (strength of the impact)



For sliding doors/fixed glazing

00111984



For Windows & Doors

00111987

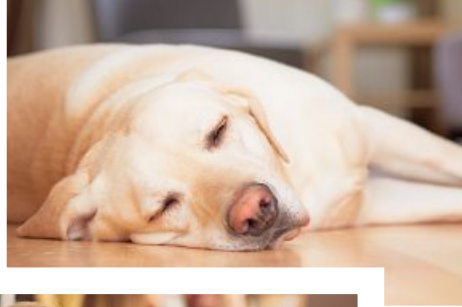

Motion Sensors



- Alarm triggered by motion
- Panic feature: instant alarm
- Controllable via remote control



For wall mounting

00111983



For ceiling mounting

00111988

Dummy Security Cameras



- Realistic imitation
- Deterrent even from far away
- Red flashing LED

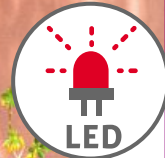

For wall mounting

00111993



For ceiling mounting

00111992



Complete protection at home

For perfect coverage, all the security components should be in communication with each other. The FeelSafe alarm system accomplishes this reliably and conveniently via radio. Installation and starting up are a breeze, too.

- Eight safety zones adjustable
- Loud alarm (approx. 120 dB)
- Range up to 250 m (open space)
- Easy, wireless installation
- Tamper-proof and battery backup
- Adjustable alarm duration
- Countdown function can be muted
- Comfortable control via remote control
- Flexibly expandable



Scope of delivery:



Base station



Motion sensor



Window/ Door sensor



Remote control



Outdoor Siren

If the neighbours live some way off, then it's important to call attention to the situation when a burglary is under way. This can be accomplished effectively with an additional outdoor siren. Sabotage countermeasures ensure that the alarm will sound if anyone tries to tamper with it.

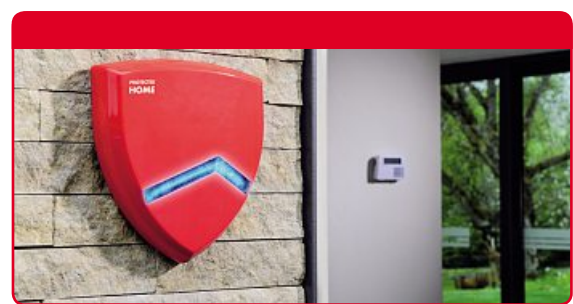



More safety in everyday life

Emergency Alarm

This is perfect for persons such as the elderly or ailing who are more likely to get into emergency situations, or just as protection against intruders. It can be installed with a wall mount or worn on a strap or lanyard.



Alarm Doorstop

The quick, easy but effective safeguarding of doors. Switch on, place behind the door and it's ready! With this product you can also sleep relaxed in your hotel-room when travelling.

Second practical effect: Acoustic alarm when small children open the doors unnoticed.



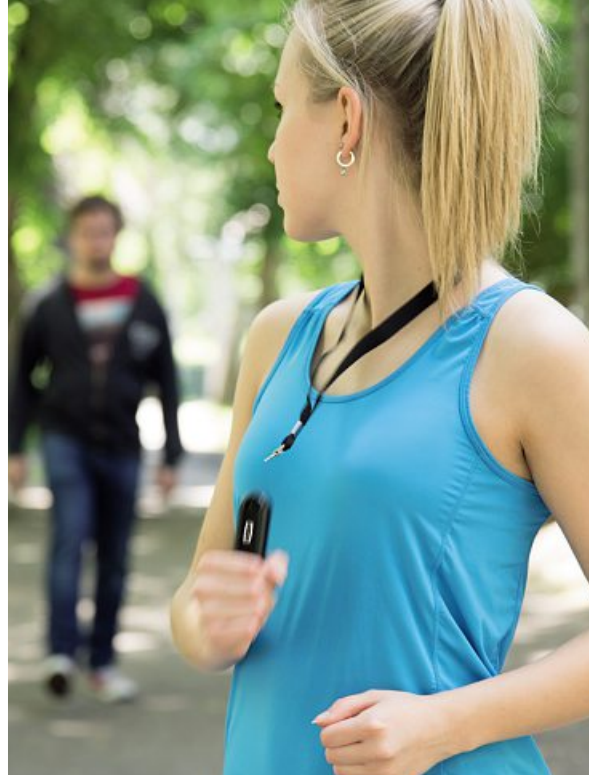
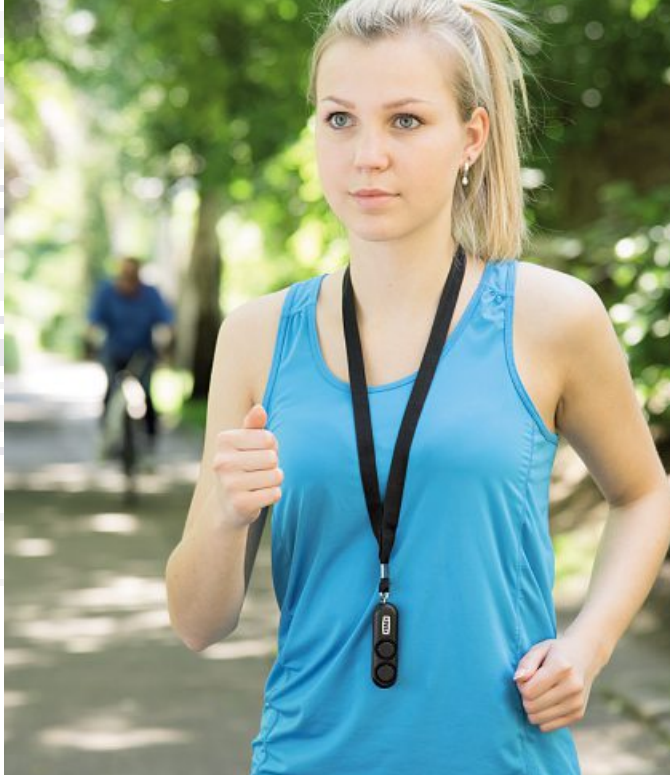

Personal Safety

Mobil Alarm siren

Whether jogging in the woods or coming home on a dark street, you'll feel safer with a mobile alarm siren. If it comes to the worst, one tug is enough and a piercing alarm signal sounds. Some models are additionally equipped with a practical electric torch.



Advertising Media

The perfect PoS presentation

There are many different store shelving systems available for retail. The package sizes of Home Safety are chosen to guarantee a clean, structured look on shelves. Customers can find what they need without a lot of casting about. Attention-grabbing promotional materials generate interest and provide important, sales-relevant information.



1 PART

Sicheres Zuhause

100+ Fenster-Sensoren

- Magnetkontakte an beiden Seiten des Fensters montieren. Bei Öffnen werden die Kontakte getrennt und es wird ein Alarm ausgelöst.

Bis zu 120 dB (EXTREM LAUT)

Bewegungssensoren

- Handfunktion für sofortiges Auslösen des Alarms
- Bewegungsgeschwindigkeit über 10 km/h
- Auslöser: manuelle Alarm- und Disarmierung

All-in-One System

Funk-Alarm-System „FeelSafe“

- Anti-Diebstahl
- Einbruch
- Brand
- Schlagempfang
- Flutwarnung
- 24h Überwachung
- 24h Alarm
- 24h Notruf

Lieferumfang: (beliebig erweiterbar)

- 1x Funk-Alarm-System
- 1x Funk-Alarm-System
- 1x Funk-Alarm-System

Zusätzlich erhältlich:

- 1x Funk-Alarm-System
- 1x Funk-Alarm-System
- 1x Funk-Alarm-System

Glasbruchsensoren

- Zur Erkennung von Glasbruch
- Sensoren für Fenster und Türen
- Automatische Alarme

Überwachungskamera-Attrappen

- Fluchweg durch Optik
- Abwechslung LED

Panel Home Safety

For Tego 1 metre

For Tego 1,25 metre

980 x 210 mm
Item No. 00098452

1230 x 210 mm
Item No. 00098453

980 x 600 mm
Item No. 00098454

1230 x 210 mm
Item No. 00098455

2 PARTS

Sicheres Zuhause

100+ Fenster-Sensoren

- Magnetkontakte an beiden Seiten des Fensters montieren. Bei Öffnen werden die Kontakte getrennt und es wird ein Alarm ausgelöst.

Bis zu 120 dB (EXTREM LAUT)

Bewegungssensoren

- Handfunktion für sofortiges Auslösen des Alarms
- Bewegungsgeschwindigkeit über 10 km/h
- Auslöser: manuelle Alarm- und Disarmierung

All-in-One System

Funk-Alarm-System „FeelSafe“

- Anti-Diebstahl
- Einbruch
- Brand
- Schlagempfang
- Flutwarnung
- 24h Überwachung
- 24h Alarm
- 24h Notruf

Lieferumfang: (beliebig erweiterbar)

- 1x Funk-Alarm-System
- 1x Funk-Alarm-System
- 1x Funk-Alarm-System

Zusätzlich erhältlich:

- 1x Funk-Alarm-System
- 1x Funk-Alarm-System
- 1x Funk-Alarm-System

Glasbruchsensoren

- Zur Erkennung von Glasbruch
- Sensoren für Fenster und Türen
- Automatische Alarme

Überwachungskamera-Attrappen

- Fluchweg durch Optik
- Abwechslung LED

Panel Home Safety 2-parts

For Tego 1 metre

For Tego 1,25 metre

each: 980 x 210 mm
Item No. 00098448

each: 1230 x 210 mm
Item No. 00098449

each: 980 x 600 mm
Item No. 00098450

each: 1230 x 600 mm
Item No. 00098451

xavax Mehr Sicherheit im Alltag

All-in-One System

Funk-Alarm-System „FeelSafe“

- Anti-Diebstahl
- Einbruch
- Brand
- Schlagempfang
- Flutwarnung
- 24h Überwachung
- 24h Alarm
- 24h Notruf

Lieferumfang: (beliebig erweiterbar)

- 1x Funk-Alarm-System
- 1x Funk-Alarm-System
- 1x Funk-Alarm-System

Zusätzlich erhältlich:

- 1x Funk-Alarm-System
- 1x Funk-Alarm-System
- 1x Funk-Alarm-System

Mobile Safety

Alarm-Türstopper

- Anti-Diebstahl
- Zur Abschreckung einwirkender Personen

Mobile Alarmsensoren

- Handlich und immer griffbar
- Qualität der Verarbeitung
- Zur Abschreckung einwirkender Personen

**Dangler poster
Home Safety**

627 x 800 mm
printed on both sides
for hanging up
Item No. 00098456



**Shelf divider
Home Safety**

300 x 1000 mm
printed on both sides
for hanging up
Item No. 00098457



Item No. 00098670
Hooks into pillar.



Item No. 00098694
Hooks into perforated
sheets.

**Poster-Set for Floor stand
Home Safety**

4-sides
each: 500 x 300 mm
Item No. 00098497

Floor stand

500 x 500 x 1800 mm
Item No. 00096306





Lighting

Coffee & Tea

Household goods & Decoration

Small household appliances

Cleaning & Care

Accessories for household

Get tips and more ideas for profitable POS displays in our flagship store. To arrange a personal visit to our store in Monheim, simply contact your sales representative, who would be happy to schedule an individual appointment for you.

Flyer Home Safety

Neat portfolio information to place directly in the hangings.

90 x 230 mm
Item No 00098491



Wireless Alarm System "Feel Safe"

Motion alarm sensor

Glass Breakage Detector

Window / door alarm sensor

Emergency Alarm

Surveillance Camera Dummy

Personal Alarm

Alarm Doorstop



"FeelSafe" Wireless Alarm System

Set Contents in Pieces	7
Component	1 Base Station/1 Motion Alarm Sensor/1 Remote Control/2 Window/Door Sensors

- Up to eight safety zones adjustable, e.g. zone 1: living room and children's room, zone 2: kitchen and bathroom
- Attracts attention from passers-by in case of an emergency
- In case of a security breach a loud alarm (approx. 120 dB) is triggered
- Control possible via the base station or remote control
- Displays the operating state:
Alarm mode (Arm): siren tone
Signal mode (Alert): ding dong tone
Home mode (Home): Arm and/or Alert adjustable
Standby mode (Standby Mode)
- The countdown function allows you to deactivate the alarm system in a fixed period of time (10 - 60 sec.)
- Countdown function can be muted
- Adjustable alarm duration
- Range: up to 250 m (open space)
- Low battery indicator
- Battery backup in case of a power failure (with battery indicator)
- Quick and easy to mount
- Tamper-proof



Remote Control for "FeelSafe" Wireless Alarm System

Signal Transmission	Wireless
Battery Type	CR2032
Range	60 m
Colour	White

- Accessory for the „FeelSafe“ wireless alarm system
- Remote control for controlling the alarm system inside and outside the house
- 4-button remote control with 4 modes (activation/deactivation, alarm and home) and a "panic function" for immediate activation of the alarm



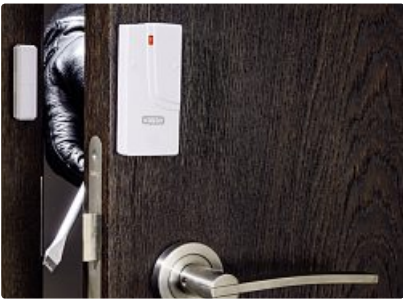

Window/Door Alarm Sensor for "FeelSafe" Wireless Alarm System

Max. Range	250 m
Attachment	Adhesive Pad
Flat	-
Material	Plastic
Model	Door Sensor/Window Sensor
Battery Type	Micro AAA, 1.5V
Number of Batteries	2
Power Supply	Battery
Colour	White

- Accessory for the „FeelSafe“ wireless alarm system
- The base station triggers a loud alarm (approx. 120 dB) in case of unauthorized opening of windows or doors, i.e. when the two magnetic contacts are separated
- The magnetic contact can be mounted on the right or left side of the sensor
- For discouraging unauthorized persons (e.g. burglars)
- Attracts attention from passers-by in case of an emergency
- Ideal for protecting all entry points of houses, garages, gardens, etc.
- Low battery indicator
- Quick and easy to mount



Motion Alarm Sensor for "FeelSafe" Wireless Alarm System

Max. Range	250 m
Material	Plastic
Battery Type	9V E-Block
Number of Batteries	1
Power Supply	Battery
Colour	White

- Accessory for the „FeelSafe“ wireless alarm system
- Detects movements in a specific zone and sends a radio message to the base station which triggers an alarm (approx. 120 dB) when unauthorized persons enter e.g. a room
- 110° wide-angle detection with adjustable direction angle
- With adjustable sensitivity levels (L = 4 m, M = 6 m, H = 15 m)
- For discouraging unauthorized persons (e.g. burglars)
- Attracts attention from passers-by in case of an emergency
- For protecting all entry points of houses, garages, gardens, etc.
- Ideal for a number of different areas, e.g. rooms, halls, staircases, sheds, front and back doors
- Low battery indicator
- Quick and easy to mount



Outdoor Siren for "FeelSafe" Wireless Alarm System

Loudness	120 dB
Material	Plastic
Battery Type	Mono D, 1.5V
Number of Batteries	4
Power Supply	Battery
Colour	Red

- Accessory for the „FeelSafe“ wireless alarm system
- The outdoor siren is activated by the "FeelSafe" wireless alarm system when unauthorized persons enter a guarded zone (120 dB)
- With flash light function for better visual perception
- With sabotage protection: each unauthorized access triggers the alarm
- For discouraging unauthorized persons (e.g. burglars)
- Attracts attention from passers-by in case of an emergency
- When mounting the siren make sure that it is clearly visible but not easy to reach, e.g. on a house wall
- Adjustable alarm duration (1 - 10 min.)
- Batteries need to be replaced after about 2 years
- Low battery indicator
- Quick and easy to mount



- Wireless Alarm System "Feel Safe"
- Motion alarm sensor**
- Glass Breakage Detector
- Window / door alarm sensor
- Emergency Alarm
- Surveillance Camera Dummy
- Personal Alarm
- Alarm Doorstop



Motion Alarm Sensor for Ceilings

Max. Range	7 m
Loudness	115 dB
Material	Plastic
Remote Control	✓
Battery Type	Micro AAA
Number of Batteries	3
Power Supply	Battery
Colour	White

- Detects movements in a specific zone and triggers an alarm (approx. 115 dB) along with a red flashing LED when unauthorized persons enter e.g. a room
- Selection between alarm siren and bell tone
- Detection zone: horizontally max. approx. 360°, vertically max. approx. 100°
- For discouraging unauthorized persons (e.g. burglars)
- Attracts attention from passers-by in case of an emergency
- Ideal for mounting on ceilings of houses, sheds, garages, etc.
- Delay function allows you to enter and leave a room or building without the alarm being activated
- Easy to control with a remote control (activation/deactivation)
- Low battery warning indicator
- Quick and easy to mount

111988

10	BC	
215 x 230		

4 047443 291738



Motion Alarm Sensor with Remote Control

Max. Range	7 m
Loudness	118 dB
Material	Plastic
Remote Control	✓
Battery Type	Micro AAA
Number of Batteries	3
Power Supply	Battery
Colour	White

- Detects movements in a specific zone and triggers an alarm (approx. 118 dB) along with a red flashing LED when unauthorized persons enter e.g. a room
- Selection between alarm siren and bell tone
- 110° wide-angle detection with adjustable direction angle
- Motion alarm sensor with a compact remote control (activation or deactivation)
- For discouraging unauthorized persons (e.g. burglars)
- Attracts attention from passers-by in case of an emergency
- Ideal for protecting all entry points of houses, garages, gardens, etc.
- Delay function allows you to enter and leave a room or building without the alarm being activated
- Quick and easy to mount

111983

10	BC	
140 x 230		

4 047443 291677



Glass Breakage Detector, flat

The sensor can react to various vibration intensities – perfect for glass or sliding doors

Item No. 111984

Wireless Alarm System "Feel Safe"

Motion alarm sensor

Glass Breakage Detector

Window / door alarm sensor

Emergency Alarm

Surveillance Camera Dummy

Personal Alarm

Alarm Doorstop



Glass Breakage Detector, flat

Attachment	Adheos Pad
Flat	✓
Loudness	95 dB
Material	Plastic
Battery Type	CR2032
Number of Batteries	2
Power Supply	Battery
Colour	White

- Two adjustable sensitivities ("HI"/"LOW"): depending on the sensitivity the sensor responds to vibrations of different strengths
- For discouraging unauthorized persons (e.g. burglars)
- Attracts attention from passers-by in case of an emergency
- Due to its slim design ideal e.g. for glass sliding doors or terrace doors
- Warning that is visible from the outside
- On and off switch
- Battery test button
- Quick and easy to mount



Glass Breakage Detector

Attachment	Adheos Pad
Flat	-
Loudness	110 dB
Material	Plastic
Battery Type	LR44
Number of Batteries	4
Power Supply	Battery
Colour	White

- Two adjustable sensitivities ("HI"/"LOW"): depending on the sensitivity the sensor responds to vibrations of different strengths
- For discouraging unauthorized persons (e.g. burglars)
- Attracts attention from passers-by in case of an emergency
- Battery test button
- Quick and easy to mount



- Wireless Alarm System "Feel Safe"
- Motion alarm sensor
- Glass Breakage Detector
- Window / door alarm sensor**
- Emergency Alarm
- Surveillance Camera Dummy
- Personal Alarm
- Alarm Doorstop



Window/Door Alarm Sensor with PIN Code

Attachment	Adhesive Pad
Flat	-
Loudness	120 dB
Material	Plastic
Model	Door Sensor/Window Sensor
Pin Code	✓
Battery Type	Micro AAA, 1.5V
Number of Batteries	3
Power Supply	Battery
Colour	White

- Selection between alarm sirene and bell tone
- The magnetic contact can be mounted on the right or left side of the sensor
- For discouraging unauthorized persons (e.g. burglars)
- Attracts attention from passers-by in case of an emergency
- Ideal for protecting all entry points of houses, garages, gardens, etc.
- Can be activated and deactivated by entering a PIN code
- Alarm duration: 30 seconds if the alarm is not deactivated
- Delay function allows you to enter and leave a room or building without the alarm being activated
- Low battery indicator
- Quick and easy to mount

111982

10	BC	4 047443 291639
140 x 230		



Window/Door Alarm Sensor, flat

Attachment	Adhesive Pad
Flat	✓
Loudness	95 dB
Material	Plastic
Model	Door Sensor/Window Sensor
Pin Code	-
Battery Type	CR2032
Number of Batteries	2
Power Supply	Battery
Colour	White

- Flat window/door alarm sensor with an alarm siren (approx. 95 dB)
- For discouraging unauthorized persons (e.g. burglars)
- Attracts attention from passers-by in case of an emergency
- Ideal for protecting all entry points of houses, garages, gardens, etc.
- Due to its slim design ideal e.g. for glass sliding doors or terrace doors
- On and off switch
- Battery test button
- Quick and easy to mount

111985

10	BC	4 047443 291707
140 x 230		

Lighting

Coffee & Tea

Household goods & Decoration

Small household appliances

Cleaning & Care

Energy & Technology

Accessories for household appliances



Window / Door Alarm Sensor, flat

Due to it's slim design ideal to protect glass sliding doors

Item No. 111985



Window/Door Alarm Sensor

Attachment	Adhesive Pad
Flat	-
Loudness	115 dB
Material	Plastic
Model	Door Sensor/Window Sensor
Pin Code	-
Battery Type	LR44
Number of Batteries	4
Power Supply	Battery
Colour	White

- Selection between alarm sirene and bell tone
- The magnetic contact can be mounted on the right or left side of the sensor
- Window/door alarm sensor with an alarm siren (approx. 115 dB)
- For discouraging unauthorized persons (e.g. burglars)
- Attracts attention from passers-by in case of an emergency
- Ideal for protecting all entry points of houses, garages, etc.
- Battery test button
- Quick and easy to mount



Wireless Alarm System "Feel Safe"

Motion alarm sensor

Glass Breakage Detector

Window / door alarm sensor

Emergency Alarm

Surveillance Camera Dummy

Personal Alarm

Alarm Doorstop



Emergency Alarm

Additional alarm button	-
Flashlight	-
Loudness	118 dB
Material	Plastic
Battery Type	Micro AAA
Number of Batteries	2
Power Supply	Battery
Colour	Red
Place to Fasten	Wad +

- For discouraging unauthorized persons (e.g. burglars)
- Attracts attention from passers-by in case of an emergency
- Ideal for the elderly or sick persons that are caught in an emergency or for protection e.g. from intruders
- Mounting by means of a wall bracket or for using with a neck strap
- Low battery indicator
- Remove or insert the metal pin to trigger or stop the alarm or press the on/off switch
- Quick and easy to mount



- Wireless Alarm System "Feel Safe"
- Motion alarm sensor
- Glass Breakage Detector
- Window / door alarm sensor
- Emergency Alarm
- Surveillance Camera Dummy**
- Personal Alarm
- Alarm Doorstop



Surveillance Camera Dummy, dome

Material	Plastic
Battery Type	AA Mignon
Number of Batteries	2
Power Supply	Battery
Colour	White

- Dummy dome camera
- For discouraging unauthorized persons (e.g. burglars)
- Remarkably good imitation
- Red flashing LED
- Quick and easy to mount



Surveillance Camera Dummy

Material	Plastic
Battery Type	AA Mignon
Number of Batteries	2
Power Supply	Battery
Colour	Silver

- For discouraging unauthorized persons (e.g. burglars)
- Remarkably good imitation
- Red flashing LED
- Quick and easy to mount



- Wireless Alarm System "Feel Safe"
- Motion alarm sensor
- Glass Breakage Detector
- Window / door alarm sensor
- Emergency Alarm
- Surveillance Camera Dummy
- Personal Alarm**
- Alarm Doorstop



"Mini" Personal Alarm

Additional alarm button	-
Flashlight	-
Loudness	110 dB
Material	Plastic
Battery Type	LR41
Number of Batteries	4
Power Supply	Battery
Colour	Black
Place to Fasten	Key

- Can be attached e.g. to a bunch of keys or to a handbag which means that the alarm is always ready to hand
- Personal security alarm with a keychain
- Small, handy and easy to use
- For emergency situations, e.g. for discouraging attackers
- Attracts attention from passers-by in case of an emergency
- Remove or insert the metal pin to trigger or stop the alarm

111994

10	BC
90 x 230	

4 047443 291882



"Mini" Personal Alarm

Additional alarm button	-
Flashlight	✓
Loudness	115 dB
Material	Plastic
Battery Type	LR44
Number of Batteries	4
Power Supply	Battery
Colour	Black
Place to Fasten	Bag/Key/Wrist

- Can be attached e.g. to a bunch of keys or to a handbag which means that the alarm is always ready to hand
- The LED lamp and alarm can be used independently from one another
- Personal security alarm with a keychain and a hand strap
- Small, handy and easy to use
- For emergency situations, e.g. for discouraging attackers
- Attracts attention from passers-by in case of an emergency
- The integrated LED lamp can also be used as a torch (especially practical when it is dark, e.g. for locks)
- Remove or insert the metal pin to trigger or stop the alarm

111995

10	BC
90 x 230	

4 047443 291899

Lighting

Coffee & Tea

Household goods & Decoration

Small household appliances

Cleaning & Care

Energy & Technology

Accessories for household appliances



„Midi“ Personal Alarm

Safe when on the go – always ready to hand,
includes LED torch

Item No. 111995

- Wireless Alarm System "Feel Safe"
- Motion alarm sensor
- Glass Breakage Detector
- Window / door alarm sensor
- Emergency Alarm
- Surveillance Camera Dummy
- Personal Alarm
- Alarm Doorstop**



Alarm Doorstop

Loudness	118 dB
Material	Plastic
Battery Type	9V E-Block
Number of Batteries	1
Colour	White

- For discouraging unauthorized persons (e.g. burglars)
- Attracts attention from passers-by in case of an emergency
- Also suitable for travellers, e.g. at doors of hotel rooms
- Can also be used as a "normal" doorstop when the alarm is deactivated
- On and off switch
- Low battery indicator
- No mounting required: position the doorstop at the door, activate it and you're done

111989

10	BC	12,99 €	
140 x 230			

4 047443 291745



SMART HOME



Smart Home

Who hasn't had high heating costs and awkwardly placed power outlets? In the colder months especially, heating costs can quickly spiral out of control if you don't regulate them correctly. The same with outdoor lighting, which is often fitted to power sources that are hard to access. The new "Smart Home" products from Xavax make these problems a thing of the past. Its remote radiator controllers let you control every radiator in your house easily using an app and Bluetooth on a smartphone or tablet. The radio-controlled power outlets help you to keep energy costs in check and make it much easier to access sockets. See for yourself!



Comfortable control via App

Convenient manual or time-controlled regulation using an app on your smartphone or tablet. Just download the app in the Apple Store or on Google Play, programme it and transfer the data via Bluetooth 4.0 - done!



Remote radiator controller/timer switch

The remote radiator controller and timer switch function lets you regulate the temperature in your rooms quickly and easily from a smartphone or tablet. It lets you keep an eye on your temperatures and the resulting costs, giving you the potential to make enormous savings.



Bluetooth
SMART

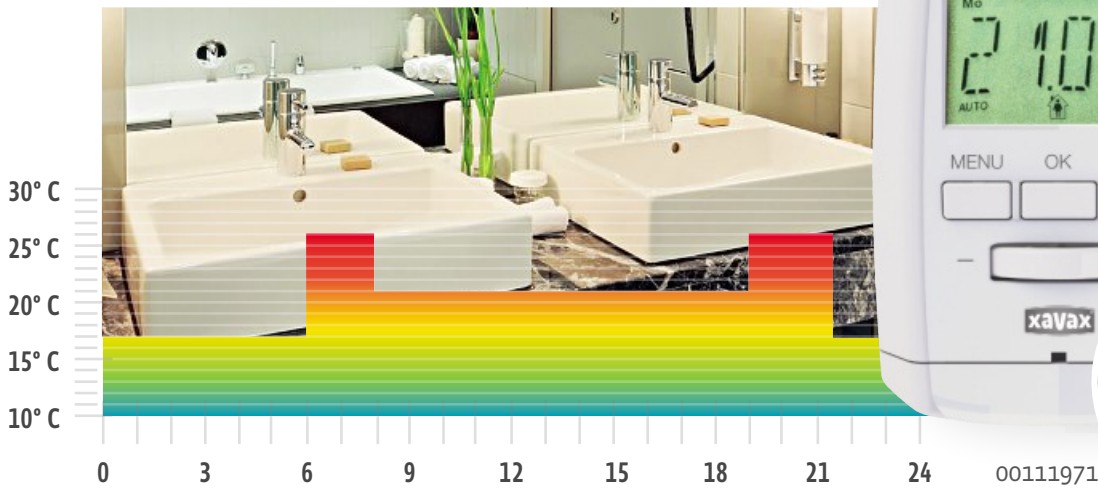

Save up to
30%
Energy

Radio power outlet

The radio power outlet is extremely practical for power outlets that are hard to reach. Avoid the irritation of crawling and struggling on the floor to access a power outlet and set and connect the timer switches for lighting and similar devices correctly. Simply plug the radio power outlet in and control everything at your leisure from your smartphone or tablet.



Bluetooth
SMART

00111970



Radio Socket

Regulator for Radiators



Wireless Socket, Bluetooth

Maximum Load	3500 W
Number of Radio Sockets	1
Range	Approx. 10 m
Colour	White

- Easy switch on and off as well as programming of the power outlet via a terminal device e.g. a smartphone or tablet PC
- Easy programming via app and data transfer via Bluetooth Smart
- App for smartphone and/or tablet available for free in the respective shop for iOS and Android
- Up to 4 individually programmable switching times possible per weekday
- Can be switched on and off at any time, either manually or via app
- Manual switching on the power outlet possible as well as function lock via child protection
- System requirement:
 - Bluetooth Smart Smart
 - As of iOS 7 or Android 4.3



Radio Socket

Regulator for Radiators



Wireless Radiator Control, Bluetooth Smart

Connection	M 30 x 1,5
Adapter	Danfoss RA/Danfoss RAV/ Danfoss RAVL
Remote Control	-
External Dimension (D x H x W)	8,5 x 6,3 x 5,3 cm
Approx. Battery Service Life	3 Years
Colour	White

- Easy programming of the radiator control via a terminal device e.g. a smartphone or tablet PC
- Easy programming via app and data transfer via Bluetooth Smart
- App for smartphone and/or tablet available for free in the respective shop for iOS and Android
- Up to 4 individually programmable switching times possible per weekday
- Up to 8 individually programmable periods of time (holiday function)
- Temperature control possible at any time, either manually or via app
- Manual switching on the radiator control possible as well as function stop via child protection
- No tools needed for installation
- Suitable for many valve bottom parts e.g. from Heimeier, Danfoss, Honeywell Braukmann, Honeywell MNG, Oventrop from about 1996 and others
- Incl. 3 adapters, one each for Danfoss RA, Danfoss RAV, Danfoss RAVL
- Bluetooth Smart
- As of iOS 7 or Android 4.3



Regulator for Radiators

Thermostat Valve Adapter

Radiator Bleeder



Radiator Control

Connection	M 30 x 1,5
Adapter	Danfoss RA/Danfoss RAV/ Danfoss RAVL
Remote Control	-
Outside Dimensions W x D x H	5.3 x 8.5 x 6.3 cm
Approx. Battery Service Life	3 Years
Colour	White

- Programmable radiator control for creating individual consumption and saving profiles
- Up to 8 individually programmable switching times possible per weekday
- No tools needed for installation
- Easy to use
- Extremely quiet running
- Suitable for many valve bodies, for example from Heimeier, Danfoss, Honeywell Braukmann, Honeywell MNG, Oventrop built since 1996 and others
- Incl. 3 adapters, one each for Danfoss RA, Danfoss RAV, Danfoss RAVL



Regulator for Radiators

Thermostat Valve Adapter

Radiator Bleeder



Adapter for Radiator Valves with M28 x 1.5 mm Connection Thread

External Connection Thread	30 x 1,5 mm
Internal Connection Thread	M 28 x 1,5 mm
Material	Brass

- The adapter is suitable for nearly all standard radiator valves with a connection thread of M28 x 1.5 mm
- The following companies produce radiator valves with these dimensions: Herz, MMA, Remagg, TA, Comap, Markaryds, SAN, Slovarm
- Simply screw on to mount - no special tools are required
- The adapter can be used for the following Xavax articles: 00111850, 00111923

111945

6	BC	
90 x 155		

4 047443 148827

Regulator for Radiators

Thermostat Valve Adapter

Radiator Bleeder



"VHE" Fully Automatic Radiator Bleeder

Material	Brass
Maximum Operating Pressure	8,5 bar
Maximum Operating Temperature	100 °C
Minimum Operating Pressure	0.1 bar

- Makes radiator bleeding several times a year unnecessary and should be installed on every radiator
- It automatically and continuously bleeds water-running systems such as radiators, piping, under-floor heating distributors, etc.
- No more awkward bleeding by hand in adverse conditions and with difficult access
- A qualified specialist for this simple yet costly service is no longer necessary
- No more bothersome radiator gurgling
- The 1/2" (12.7 mm) valve is installed with a SW19 open-ended spanner and is self-sealing - sealing with hemp or Teflon tape is not required

111859

6	BC	
90 x 155		

4 047443 178930





Accessories for household appliances

Device Connection, sanitary	258
Device Connection, electrical	270
Washing & Drying	274
Ironing	290
Refrigerating & freezing	295
Electric stove	303
Extractor hood	321
Microwave	327
Overview of vacuum cleaner bags	334
Vacuum cleaner	338

Accessories for household appliances

The helpers in the background are always there, even when they aren't really noticed. But what if they happen to fail and need to be replaced? Xavax offers a large selection of accessories for household appliances that fit perfectly and last a long time. This ensures that quality appliances, whether sanitary or electrical, will last a long time. In addition, there are many products in our range that simplify everyday life and offer additional value for the customer. For example, bases for washing machines and dryers make their use easier on the back.





- Filtration performance tested
- Suction power tested
- Operating life tested

Accessories for over 8000 vacuum cleaners

The Xavax product range includes vacuum cleaner bags, floor nozzles, hypo-allergenic filters and repair kits for over 8000 different appliances.

All the vacuum cleaner bags are "Made in Germany" and those made of reliable Xavax "MicroMulti-Fleece" with a plastic connection tab are now TÜV-approved.

Floor nozzles for all types of floors and upholstery nozzles round out this versatile product range.

A quick way to find the appropriate vacuum cleaner bag



- Go to www.xavax.eu/vacuum-cleaner-assistant
- Select the vacuum cleaner brand/device manufacturer.
- Choose the device type.
- Print out the label with the Xavax name to take it along with you or send it to yourself by email.

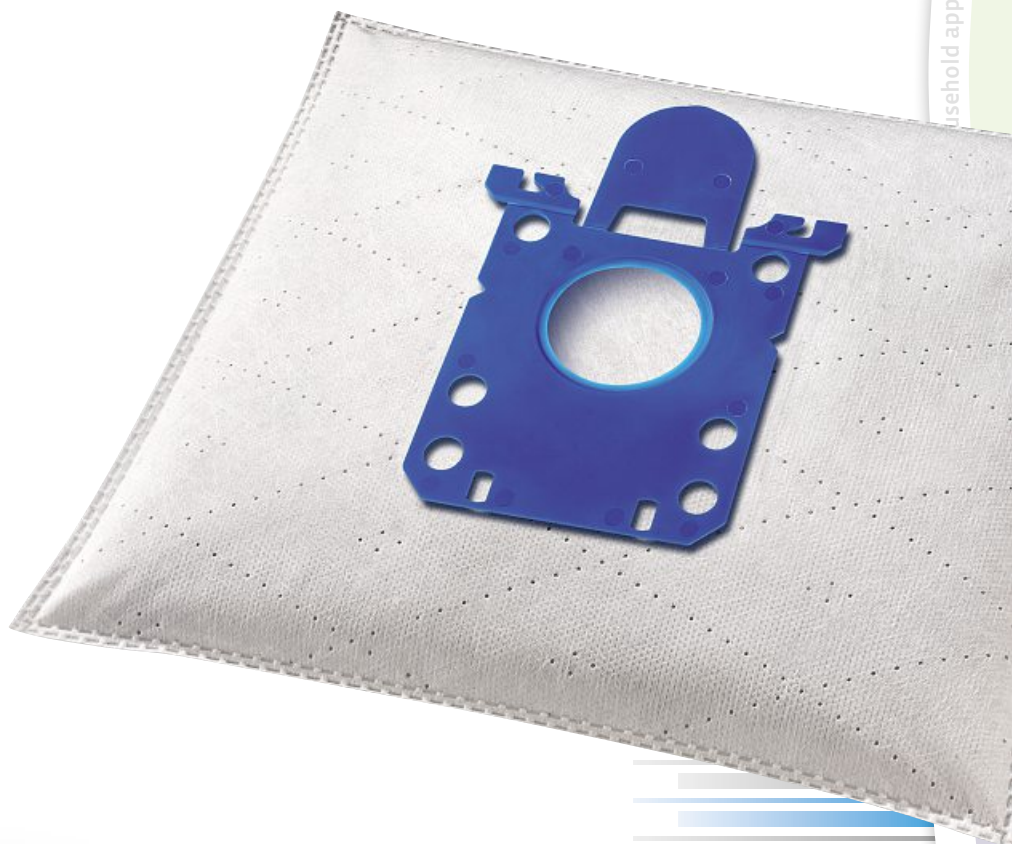



Range of services

Xavax offers a specially tailored range of services specifically for the supply of household appliances, their installation at the customer's premises, or service work.

We have deliberately done away with elaborate explanations and sales packaging because you as a professional already know exactly what you need. The practical and space-saving poly bag enables you to immediately identify the bag contents at a glance. In terms of quantities, containers have also been adapted for a higher throughput. This naturally has a positive effect on the purchase price and in turn increases your margins.

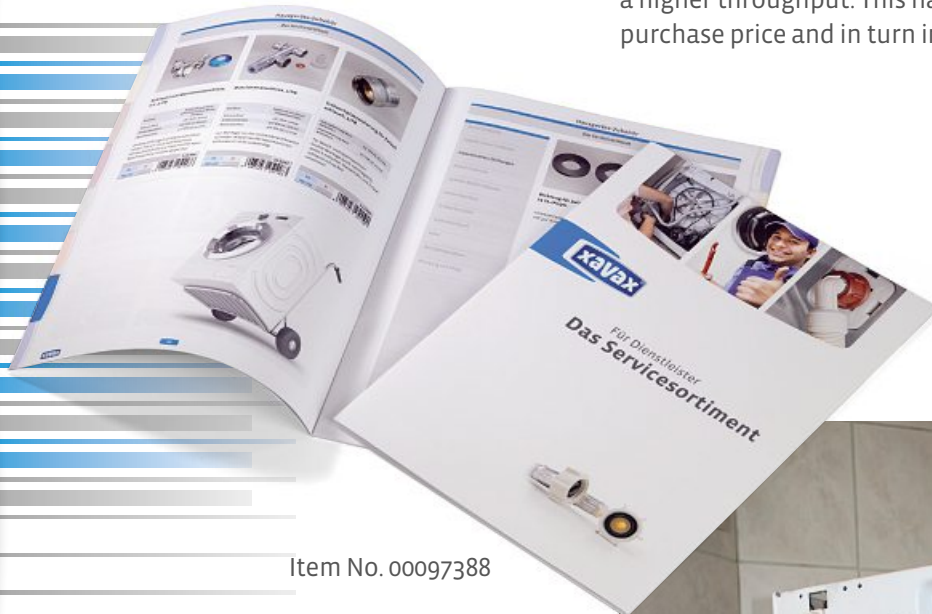

Item No. 00097388





The Range - Everything you need

In principle, the number of products that are needed very regularly is limited. Our special service products cover all of these needs. Service customers can, of course, obtain infrequently requested products from the Xavax product range for household appliances to enable you to individually expand your product range.

Workshop organisation

In addition to the workshop and servicing product range, Xavax also offers matching, individually labelled servicing shelving upon request. It will help you find the right product quickly and makes replenishing stock easier. What's more, everything is there where it belongs!



Item No. 00098672

- Angle valve
- Supply hose
- Hose extension
- Hose connector
- Supply hose seal
- Hose break protection
- Hose clip
- Drain hose
- Hose connector
- Siphon connection



Angle Valve with Machine Connector

Connection	Copper Tube Connection/ Hose Connection/ Water Connection
Hose Connection	3/4" (DN:20), 26.9 mm
Tube Connection	3/8", (tube: 10 mm)
Water Connection	1/2" (DN:15), 21.3 mm

- Is directly installed at water connection pipes with 1/2" (21.3 mm) connection
- Hose connection: 3/4" (26.9 mm) for dishwasher/washing machine, separately lockable
- Copper pipe connection: 10 mm to water tap, separately lockable
- Chrome-plated

		111054
6	BC	
140 x 230		
4		047443 035370



Machine Connector

Connection	Copper Tube Connection/ Hose Connection
Hose Connection	3/4" (DN:20), 26.9 mm
Tube Connection	3/8", (tube: 10 mm)
Water Connection	3/8" (DN:10), 17.2 mm

- You only have to lock the angle valve for assembly (the in-house water supply does not have to be interrupted)
- The device is just inserted in the pipe that leads to the tap
- Hose connection separately lockable
- Chrome-plated

		110817
6	BC	
92 x 232		
4		047443 004963

- Angle valve
- Supply hose**
- Hose extension
- Hose connector
- Supply hose seal
- Hose break protection
- Hose clip
- Drain hose
- Hose connector
- Siphon connection



Aqua Stop Hose for Washing Machines and Dishwashers, 1.5 m

Nominal Diameter/mm 1	3/4" (DN:20), 26.9 mm
Nominal Diameter/mm 2	3/4" (DN:20), 26.9 mm
Type of Connection	Connection Nut, angled/Straight
Maximum Operating Pressure	10 bar
Maximum Temperature	93 °C
Length	-

- The outer protective sleeve prevents water damage in the case of leaks or breaks in the hose
- Water supply is stopped in the case of leaks or breaks in the hose
- Leaks are indicated by a colour signal
- VDE approved

1,5 m **110803**

5 CB 4 047443 004826

2,5 m **110804**

5 CB 4 047443 004833



Cold Water Inlet Hose for Washing Machines and Dishwashers

Nominal Diameter/mm 1	3/4" (DN:20), 26.9 mm
Nominal Diameter/mm 2	3/4" (DN:20), 26.9 mm
Type of Connection	Connection Nut, angled/Connection Nut, straight
Maximum Operating Pressure	10 bar
Maximum Temperature	25 °C
Length	-

- Filter and rubber gasket
- VDE approved

1,5 m **110800**

8 CB 4 047443 004796

2,5 m **110801**

8 CB 4 047443 004802

3,5 m **110802**

5 CB 4 047443 004819

Accessories for household appliances

Appliance connection, sanitary

Appliance connection, electrical

Washing & drying

Ironing

...

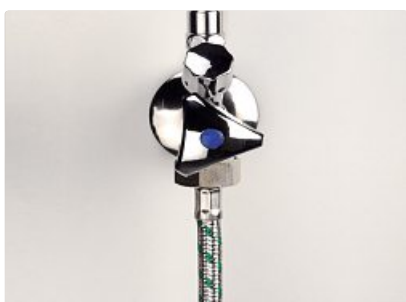

Reinforced Water Supply Hose Extension, 1 m

Nominal Diameter/mm 1	3/4" (DN:20), 26.9 mm
Nominal Diameter/mm 2	3/4" (DN:20), 26.9 mm
Type of Connection	Connection Nut, straight/ Threadfitting External Threat
Maximum Operating Pressure	10 bar
Maximum Temperature	93 °C
Length	-

- Offers the highest level of safety against water damage from washing machines, preparation equipment for drinking water or dishwasher connections (ice cube makers, boilers, side by side refrigerators, etc.)
- Also ideal for extending permanently attached supply hoses with water stop devices
- High-quality stainless steel wire braid
- DVGW type test certificate: DW-0304BT0257

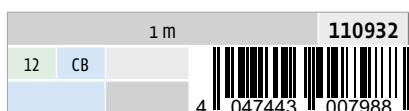

Angle valve

Supply hose

Hose extension

Hose connector

Supply hose seal

Hose break protection

Hose clip

Drain hose

Hose connector

Siphon connection



Extension Inlet Hose, cold water, 2.5 m

Nominal Diameter/mm 1	3/4" (DN:20), 26.9 mm
Nominal Diameter/mm 2	3/4" (DN:20), 26.9 mm
Type of Connection	Connection Nut, straight/ Threadfitting External Threat
Material	Nylon/Polyvinyl Chloride (PVC)
Maximum Operating Pressure	10 bar
Maximum Temperature	93 °C

- To extend firmly connected inlet hoses
- VDE approved



- Angle valve
- Supply hose
- Hose extension
- Hose connector**
- Supply hose seal
- Hose break protection
- Hose clip
- Drain hose
- Hose connector
- Siphon connection



Reinforced Water Supply Hose Extension, 3 m

Reinforced Water Supply Hose Extension, 3 m

Nominal Diameter/mm 1	3/4" (DN:20), 26.9 mm
Nominal Diameter/mm 2	3/4" (DN:20), 26.9 mm
Nominal Diameter/mm 3	3/4" (DN:20), 26.9 mm
Material	Brass
Maximum Temperature	120 °C

Nominal Diameter/mm 1	3/4" (DN:20), 26.9 mm
Nominal Diameter/mm 2	3/4" (DN:20), 26.9 mm
Nominal Diameter/mm 3	3/4" (DN:20), 26.9 mm
Material	Nylon
Maximum Temperature	80 °C

- Professional version in metal
- Also suitable for high water pressure and hot water connections
- For connecting two inlet hoses
- Internal thread to connect to the tap
- External thread to connect 2 inlet hoses

- To connect two inlet hoses

		111069	
8	BC		
90 x 155			
		4	047443 043429

		110811	
6	BC		
90 x 230			
		4	047443 004901

Angle valve

Supply hose

Hose extension

Hose connector

Supply hose seal

Hose break protection

Hose clip

Drain hose

Hose connector

Siphon connection

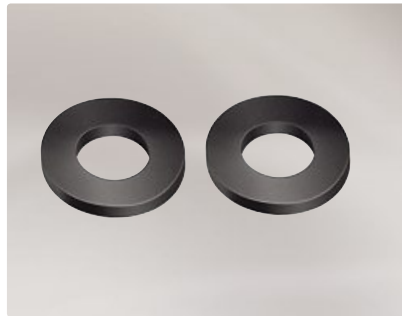

Gasket for Supply Hoses, 3/4"

Material	Ethylene-Propylene-Diene-Caoutchouc (EPDM)
Diameter (Outside)	24 mm
Height	2 mm

- Fits all supply hoses with a 3/4" connection



Gasket with Filter for Supply Hoses, 3/4"

Material	Ethylene-Propylene-Diene-Caoutchouc (EPDM)
Diameter (Outside)	24 mm
Height	2 mm

- The integrated filter prevents contaminants such as rust particles from entering the machine
 - Fits all supply hoses with 3/4" connection



Angle valve

Supply hose

Hose extension

Hose connector

Supply hose seal

Hose break protection

Hose clip

Drain hose

Hose connector

Siphon connection



Hose Break Protection for Inlet Hose

Nominal Diameter/mm 1	3/4" (DN:20), 26.9 mm
Nominal Diameter/mm 2	3/4" (DN:20), 26.9 mm

- For washing machines and dishwashers
- Easy to mount (also afterwards), is screwed between the tap and the inlet hose
- Chromium-plated

6		BC	110881	
90 x 155		4 047443 005601		

- Angle valve
- Supply hose
- Hose extension
- Hose connector
- Supply hose seal
- Hose break protection
- Hose clip**
- Drain hose
- Hose connector
- Siphon connection



Hose Break Protection for Inlet Hose

Material	Rust-Free / Screw Zinced
Diameter	20 - 32 mm

- For inlet and drain hoses
- Tape and casing made of stainless steel
- Galvanized screw

		110813	
6	BC		
90 x 155			
		4	047443 004925

Hose Clip, 2 pieces

Material	Rust-Free / Screw Zinced
Diameter	-

- For attaching exhaust pipes/hoses (max. diameter of the pipe: 110/130 mm) to tumble dryers, for extensions and wall openings
- Tape and casing made of stainless steel, galvanized screw

		110820	
6	BC		
140 x 230			
		4	047443 004994

		110835	
6	BC		
90 x 155			
		4	047443 005144

- Angle valve
- Supply hose
- Hose extension
- Hose connector
- Supply hose seal
- Hose break protection
- Hose clip
- Drain hose**
- Hose connector
- Siphon connection



Drain Hose for all Washing Machines, Dishwashers, etc., 1.5 m

Inner Diameter	21 mm
Length of Hose	1.5 m
Outside Diameter	27 mm
Connection	2x straight: 21 mm / 19 mm

- Complete with mounting elbow
- High pressure resistance (crush resistance)
- High resistance to chemicals

Drain Hose for all Washing Machines, Dishwashers, etc.

Inner Diameter	27 mm
Length of Hose	-
Outside Diameter	no specifications
Connection	straight: 21 mm / angled: 21 mm

- Complete with mounting elbow
- High pressure resistance (crush resistance)
- High resistance to chemicals

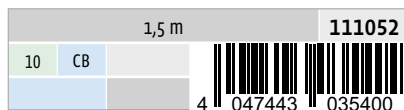

Accessories for household appliances

Appliance connection, sanitary

Appliance connection, electrical

Washing & drying

Ironing

...



Drain Hose for washing machines, dishwashers, 1.2-4 m

Inner Diameter	22 mm
Length of Hose	1.2 m to 4 m
Outside Diameter	28 mm
Connection	straight: 21 mm / straight: 21 mm

- Complete with mounting elbow
- High pressure resistance (crush resistance)
- High resistance to chemicals
- Extendible hose, can be used from 1.2 to 4 m

Angle valve

Supply hose

Hose extension

Hose connector

Supply hose seal

Hose break protection

Hose clip

Drain hose

Hose connector

Siphon connection



Supply Hose Connector, brass

Nominal Diameter/mm 1	3/4" (DN:20), 26.9 mm
Nominal Diameter/mm 2	3/4" (DN:20), 26.9 mm
Material	Brass
Maximum Temperature	120 °C
Outside Diameter	no specifications

- Professional design in metal, suitable for high water pressure and for hot water connections
- Male thread: 2 x 3/4" (19.05 mm)



110806

4 047443 004857



111095

6 BC 90 x 155 4 047443 078605

Accessories for household appliances



Supply Hose Connector

Nominal Diameter/mm 1	26.9 mm
Nominal Diameter/mm 2	26.9 mm
Material	Acrylonitrile-Butadiene-Styrene (ABS)
Maximum Temperature	no specifications
Outside Diameter	no specifications

- Hose connector for connecting supply hoses



Brass Drain Hose Connector

Nominal Diameter/mm 1	no specifications
Nominal Diameter/mm 2	no specifications
Material	Brass
Maximum Temperature	no specifications
Outside Diameter	20 x 20 mm

- Professional metal version



Supply Hose Connector

Nominal Diameter/mm 1	no specifications
Nominal Diameter/mm 2	no specifications
Material	Acrylonitrile-Butadiene-Styrene (ABS)
Maximum Temperature	120 °C
Outside Diameter	20 x 20 mm

- To connect drain hoses





Y-Connector for Drain Hose

Nominal Diameter/mm 1	no specifications
Nominal Diameter/mm 2	no specifications
Material	Acrylonitrile-Butadiene-Styrene (ABS)
Maximum Temperature	120 °C
Outside Diameter	20 x 20 mm

- Enables the connection of two drain hoses

		110875	
6	BC		
90 x 230			
		4	047443 005540

Angle valve

Supply hose

Hose extension

Hose connector

Supply hose seal

Hose break protection

Hose clip

Drain hose

Hose connector

Siphon connection



In-Wall Waste Pipe Connection without Opening for Cleaning

Gland 1	20 mm
Nominal Diameter/mm 1	1" (DN:25), 33.7 mm
Material	Plastic

- The drain hose can be mounted to the wall connection
- Conical drain hose connection fits hoses with a diameter of 20 mm, 23 mm and 3/4 inches

		111092	
6	BC		
90 x 230			
		4	047443 076397



Waste Pipe Connection

Gland 1	20 mm
Nominal Diameter/mm 1	1" (DN:25), 33.7 mm
Material	Plastic

- For connecting drain hoses of washing machines or dishwashers to a waste pipe

		110812	
6	BC		
90 x 155			
		4	047443 004918



Waste Pipe Connection with Condensate Connection

Gland 1	8 mm
Nominal Diameter/mm 1	1" (DN:25), 33.7 mm
Material	Plastic

- Second connection for the drain hose of the condensation dryer
- 1" (33.7 mm) sleeve nut
- 1x 20 mm connection, for the drain hose of the washing machine and dishwasher

		110928	
6	BC		
90 x 155			
		4	047443 007421



Household appliance connecting cable

Stove wiring box

Power extension cable

Power cable

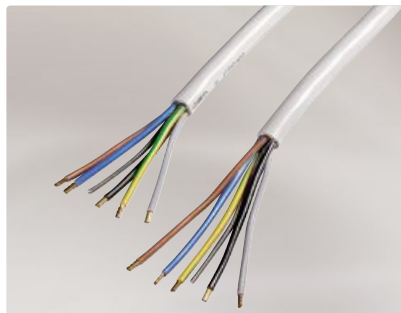

Connection Lead for Electric Cookers, white

Number of Wires	5
Cable Length	-
Wire Cross-Section	2,5 mm ²
Colour	White

- Connection cable for connecting with the stove socket
- Prefabricated connection cable
- Open ends with core cable ends
- Cable: H05VV-F 5 x 2,5 mm²

1,5 m		110826	
24	BC	4 047443 005052	
142 x 232			

2,5 m		110827	
24	BC	4 047443 005069	
216 x 230			

Household appliance connecting cable

Stove wiring box

Power extension cable

Power cable

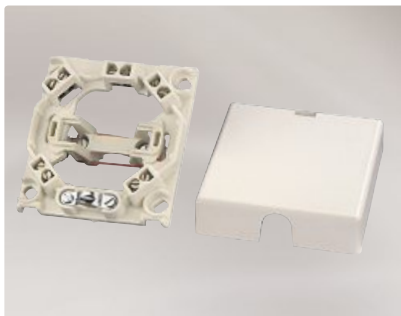

Stove Wiring Box

Equipment	5 Double Clamps/Cable Size max 2,5 mm ² /Lid
Material	Plastic
Mounting	Surface or Flush Mounting

- To connect stove leads to the house installation
- Particularly flat design
- With a break-protected cover
- Including 5 double clamps for cables up to 2.5 mm²
- Flush and surface mounting possible

		110828	
6	BC		
140 x 230		4	047443 005076

Appliance connection, sanitary

Appliance connection, electrical

Washing & drying

Ironing

...

Household appliance connecting cable

Stove wiring box

Power extension cable

Power cable



Extension Cable with Earth Contact, 3 m, white

Length	3 m
Colour	White

- Suitable for devices which consume much power, e.g. washing machines, dishwashers, driers etc.
- Cable: H05VV-F 3 x 1.5 mm²



Extension Cable with Earth Contact, 5 m, white

Length	5 m
Colour	White

- Suitable for devices which consume much power, e.g. washing machines, dishwashers, driers etc.
- Cable: H05VV-F 3 x 1.5 mm²



Household appliance connecting cable

Stove wiring box

Power extension cable

Power cable



Mains Lead, 1.5 m, black

Length	1.5 m
Colour	Black

- Plug with earth contact - power plug
- To connect electrical appliances with max. 10A (2200 W)
- Ho5VV-F 3 x 0.75 mm²
- VDE approved

6		BC	110843	
140 x 230		4 047443 005229		

Household Appliance Base

Household Appliance Stacking Kit

Transport Device

Anti-Slip Mat

Lashing Strap

Home Appliance Vibration Damper

Dryer Ball

Condenser Box

Exhaust Air Hose

Laundry Net



Universal Stand with Base Division for Washing Machine and Dryer

Height	40 cm
Length	60,3 cm
Load Capacity	150 kg
Width	60,3 cm

- Base stand for a washing machine or a dryer
- Three sides with an open front for storage or one side with a closed front for an elegant look
- With height-adjustable storage compartment for washing powder, fabric softener, etc.
- Non-slip thanks to rubber caps for the feet



Base Stand with Drawer for Washing Machines and Dryers, 61 x 50 cm

Height	30 cm
Length	50 cm
Load Capacity	80 kg
Width	61 cm

- Base stand for a standard washing machine or dryer as well as for refrigerators and freezers
- Large drawer for compact storage e.g. of washing powder and wash accessories
- Easy to mount due to the prefabricated drawer element
- High load capacity for normal machines: up to 80 kg
- Rubber mats on the feet for vibration absorption
- Base stand for a standard washing machine or a dryer
- TÜV approved
- Made in Germany





**"MEDI" Machine Base,
61 x 50 cm**

Height	30 cm
Length	50 cm
Load Capacity	80 kg
Width	61 cm

- Base stand for a standard washing machine or dryer as well as for refrigerators and freezers
- Base for compactly storing e.g. detergents and wash accessories
- The powder coated steel elements are easy to mount
- High load capacity for normal machines: up to 80 kg
- Rubber mats on the feet for vibration absorption
- Water (backflow) from gullies, high water up to 30 cm, wetness from the floor can no longer get in the machine
- TÜV approved
- Made in Germany



Household Appliance Base

Household Appliance Stacking Kit

Transport Device

Anti-Slip Mat

Lashing Strap

Home Appliance Vibration Damper

Dryer Ball

Condenser Box

Exhaust Air Hose

Laundry Net



**Stacking Kit for Washing
Machines/Dryers with Sliding Plate**

- Includes a sliding plate (holds up to 12 kg), practical storage and work surface at comfortable working height (e.g. for folding laundry, putting laundry into the machine, taking out, etc.)
- Sliding plate with a practical handle for ease of use
- Can also be used for washing machines with an oblique or arched front and for washing machines with a washing powder drawer that reaches up to the lid
- Also suitable for dryers with a cleaning flap at the lower part of the front
- Wheels attached to the side of the drawer make it easy to open the removable plate
- With pull-out lock
- Comes with a lashing strap for optimally securing the device - it can e.g. prevent the dryer from falling down due to tensile loads at the door
- Quick and easy to install as delivered preassembled
- Can be screwed on
- Universally compatible with all units with a 60 x 60 cm worktop





Stacking Kit for Washing Machine/ Dryer

- Quick and easy to install
- Universally compatible with all units with a 60 x 60 cm surface

Not suitable for:

- Washing machines with an oblique or arched front
- Washing machines with a washing powder drawer that reaches up to the lid
- Dryers with a cleaning flap at the lower part of the front



Intermediate Frame (closed front) for Washing Machine/Dryer, 60 x 60 cm

- Frame is a plug-in system, therefore easy to transport as well as quick and easy to mount
- Universally compatible with all units with a 60 x 60 cm surface
- Comes with a lashing strap for optimally securing the device - it can e.g. prevent the dryer from falling down due to tensile loads at the door

Not suitable for:

- Washing machines with an oblique or arched front
- Washing machines with a washing powder drawer that reaches up to the lid
- Dryers with a cleaning flap at the lower part of the front

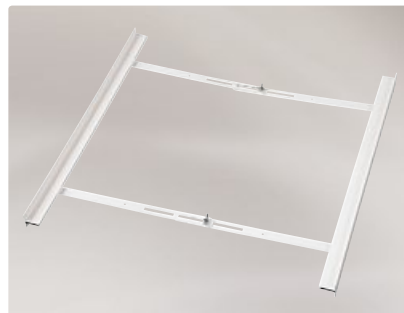

Intermediate Frame (open front) for Washing Machine and Dryer, 55 - 68 cm

- Xavax in-house development
- Frame with an expanding system, therefore easy to transport as well as quick and easy to mount
- Universally compatible with all units with a surface from 55 to 68 cm, can be adapted individually to the width of the washing machine cover
- Comes with a lashing strap for optimally securing the device - it can e.g. prevent the dryer from falling down due to tensile loads at the door

Also suitable for:

- Washing machines with an oblique or arched front
- Washing machines with a washing powder drawer that reaches up to the lid
- Dryers with a cleaning flap at the lower part of the front



110815

4 047443 004949



111378

4 047443 289803



111379

4 047443 289810



Stacking Kit II for Washing Machine/Dryer

- With a removable front panel
- Universally compatible for all washing machines with a width between 55 and 60 cm and a depth up to 60 cm. The intermediate frame can continuously be adjusted to the cover plate's width
- Quick and easy to install (without retaining spring), side rails need to be attached with screws
- 4 individual tool-free, stackable rails incl. mounting material

Also suitable for:

- Washing machines with an oblique or arched front
- Washing machines with a washing powder drawer that reaches up to the lid
- Dryers with a cleaning flap at the lower part of the front



Fixing Plates for Dryers, for sticking on, set of 4

- When a washing machine and dryer are combined to form a column, the fixing plates are stuck under the feet of the dryer
- In addition to the extremely strong adhesion, the dryer secures itself due to its weight as the fixings next to the border also have a bottom plate on which lies the dryer weight
- The glue is insensitive to moisture and changes in temperature
- Suitable for dryer feet up to a diameter of 45 mm



Household Appliance Base

Household Appliance Stacking Kit

Transport Device

Anti-Slip Mat

Lashing Strap

Home Appliance Vibration Damper

Dryer Ball

Condenser Box

Exhaust Air Hose

Laundry Net



Transport Roller for Washing Machine and Dryer

Material	Steel Plate
Maximum Load	300 kg
Max. Width	70 cm
Min. Width	40 cm

- Can easily be adjusted to the width and depth of large devices via the retractable rails
- Heavy devices can thus easily be moved on even surfaces, e.g. for transportation or for cleaning the floor
- Also suitable for furniture, plant or warehouse transport boxes
- 6 plastic rollers
- 2 lowerable brakes provide stability and absorb vibrations
- Brakes can be operated via the lever
- Non-slip plastic supports give the machines additional hold



Household Appliance Base

Household Appliance Stacking Kit

Transport Device

Anti-Slip Mat

Lashing Strap

Home Appliance Vibration Damper

Dryer Ball

Condenser Box

Exhaust Air Hose

Laundry Net

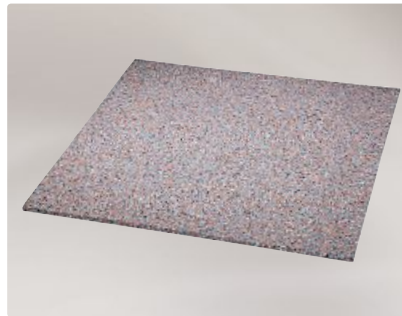

Anti-Slip Mat for Washing Machines

Width x Length	60 x 60 cm
Colour	Black

- Absorbs vibrations and prevents devices from sliding across the floor
- For noise protection and sound reduction
- Odourless
- Extremely durable and tearproof due to the high density
- Highly specified, recycled rubber granules bound with polyurethane
- Rot-proof and water compatible
- Resistant to household chemicals, limited acid and lye resistance
- Protects any kind of floor, device and machine
- Made in Germany

		111362	
10	CB		
		4 047443 199980	

Household Appliance Base

Household Appliance Stacking Kit

Transport Device

Anti-Slip Mat

Lashing Strap

Home Appliance Vibration Damper

Dryer Ball

Condenser Box

Exhaust Air Hose

Laundry Net



Lashing Strap with Lock for Tumble Dryers

Length	600 cm
--------	--------

- Put the strap around the complete column (consists of the washing machine and the dryer), thread through the lock and lash it
- The dryer is firmly secured on the washing machine after the lashing strap has been tightened
- Prevents the dryer from falling off due to tensile loads on the door
- Maximum lashing capacity: 200daN
- Material: impregnated polyester

		111359	
6	BC		
140 x 230		4	047443 191724

Household Appliance Base

Household Appliance Stacking Kit

Transport Device

Anti-Slip Mat

Lashing Strap

Home Appliance Vibration Damper

Dryer Ball

Condenser Box

Exhaust Air Hose

Laundry Net



TPE Vibration Damper

Number of Absorbers	4
Diameter	45 mm
Height	17 mm

- For absorbing operational vibrations of washing machines, dishwashers and dryers
- For increased stability and noise insulation
- Prevents slipping on smooth floors
- Protects tiles against scratches
- Universal and easy to install
- Made of thermoplastic material (PVC)
- Diameter: inside: 4,5 cm; outside: 6,5 cm





xavax[®]



"Power Pearls" wash ball

For reducing the amount of washing agent needed with 80 ceramic laundry beads
Saves money and protects the environment by reducing the amount of chemicals in rivers and bodies of water

Item No. 111376

- Household Appliance Base
- Household Appliance Stacking Kit
- Transport Device
- Anti-Slip Mat
- Lashing Strap
- Home Appliance Vibration Damper
- Dryer Ball**
- Condenser Box
- Exhaust Air Hose
- Laundry Net

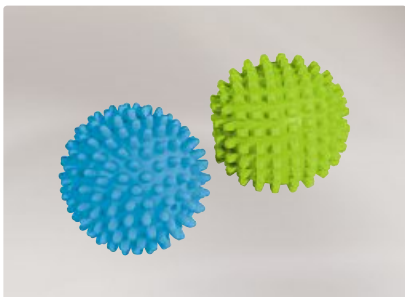

Dryer Balls, 2 pieces

Temperature Resistance up to	125 °C
Diameter	60 mm
Colour	Blue/Green

- Put the two dryer balls together with the laundry into the dryer
- Reduces the drying time by up to 25%
- Save energy and time and are not only easy on the environment but also on the purse
- Soft clothes without the use of chemicals
- Reusable for an almost unlimited period of time
- Additional information for orders: delivery in a display box possible (if 12 blisters each are ordered, delivery is made in an advantageous sales display)

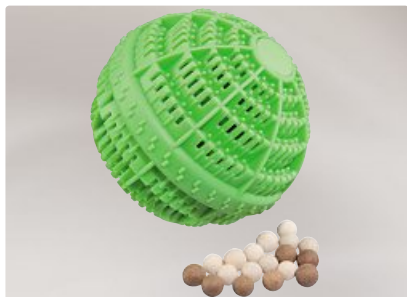

"Power Pearls" wash ball

Temperature Resistance up to	95 °C
Diameter	100 mm
Colour	Green

- Plastic ball filled with around 80 ceramic wash pearls
- The vast micro surface of the pearls filters the water and allows for improved detergent distribution
- Detergent quantity can be reduced to 1/4 of the usual amount with no sacrifice to usual cleanliness
- Ideal for those who suffer from skin irritations or allergies caused by detergent residues, as the natural pearls emit no fragrances
- Textiles are protected, colours remain brighter for longer, since the amount of chemicals per wash is vastly reduced, resulting in possible wash temperatures from cold to 95 °
- The specially shaped wash ball with its internal balls moves atypically within the drum, thus supporting the mechanical wash in the washing machine, as it rubs against textiles and thus releases dirt from fibres, disperses the wash more efficiently, and unfolds laundry more effectively
- Due to the movement of the beads, the detergent is released and foamed more efficiently in the water - so more oxygen is introduced into the wash water



Household Appliance Base

Household Appliance Stacking Kit

Transport Device

Anti-Slip Mat

Lashing Strap

Home Appliance Vibration Damper

Dryer Ball

Condenser Box

Exhaust Air Hose

Laundry Net



Condenser Box for Vented Tumble Dryers

Material	Plastic
Size	28,5 x 23,5 x 23 cm
Colour	White

- No annoying laying of the exhaust air hose through the window opening or hole in the wall
- Just attach the exhaust air hose to the extra large and sturdy condensate box (capacity: 7l)
- With additional, removable container for ice which ensures an even better condensation of the warm water vapour



- Household Appliance Base
- Household Appliance Stacking Kit
- Transport Device
- Anti-Slip Mat
- Lashing Strap
- Home Appliance Vibration Damper
- Dryer Ball
- Condenser Box
- Exhaust Air Hose**
- Laundry Net

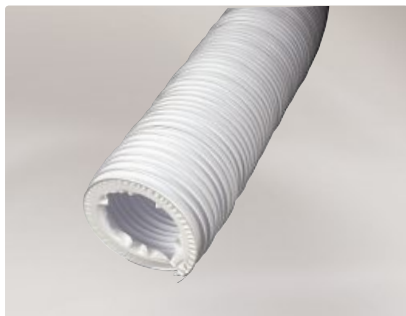

Vent Hose For Tumble Dryers

Operating Temperature	-5 °C up to + 80°C
Diameter	102 mm
Length	-

- Flexible PVC hose mounted on a spring steel helix wire
- Can be cut to length just as one likes
- Incl. 2 hose brackets, 90-110 mm



Vent Hose Adapter for Laundry Dryers

Operating Temperature	-5 °C up to + 80°C
Diameter	102 mm
Length	0.2 m

- Fits all 102 mm vent hoses
- Ideal for dryers with 100 mm connection
- Can easily be inserted in wall sleeves or wall ducts
- Allows the vent hose to be easily plugged on and off (advantageous if this one can only be mounted for drying)
- Secure fit, no hose clip needed

2 m **110944**

36 CB

4 047443 009036

4 m **110945**

18 CB

4 047443 009043

111306

6 BC

140 x 230

4 047443 119650



Drain Hose Set for Condensation Dryers

Inner Diameter	10 mm/8 mm
Length of Hose	1.5 m
Outside Diameter	14 mm/15 mm

- Set for connecting a condensation dryer to a siphon connection - no more fastidious emptying of the water receiving tank
- Consists of: 1 drain hose, 1.5 m, 1 siphon connection, 3 hose clamps, 1 non-return valve
- High pressure resistance (crush resistance)

		110903	
6	BC		
140 x 230		4 047443 006950	



45 x 25 cm oder
70 x 50 cm



Laundry net

Protects sensitive material
For up to 1 Kg washing

Item No. 110942 /110943

Appliance connection, sanitary

Appliance connection, electrical

Washing & drying

Ironing

...

Household Appliance Base

Household Appliance Stacking Kit

Transport Device

Anti-Slip Mat

Lashing Strap

Home Appliance Vibration Damper

Dryer Ball

Condenser Box

Exhaust Air Hose

Laundry Net



Laundry Net for Lingerie

Material	100% Polyester
Length	20 cm
Width	17 cm
Colour	White

- Extends the lifetime of delicate clothing
- Prevents wrinkles
- No more need to hand wash your delicates
- Zip for ease of use



Laundry Net, 45 x 25cm

Material	100% Polyester
Length	45 cm
Width	25 cm
Colour	White

- Especially suitable for curtains, full-fashioned stockings, ladies' underwear
- Easy handling by means of a zipper
- Separates small parts from the rest of the laundry
- Completely pervious to water and washing powder
- For 1 kg of laundry
- Washable up to 95°C
- 100% polyester





Laundry Net, 45 x 25cm

Material	100% Polyester
Length	70 cm
Width	50 cm
Colour	White

- Especially suited for curtains, delicate fabrics
- Zip for ease of use
- Separates delicate clothing from the rest of the laundry
- Completely pervious to water and washing powder
- Can hold up to 3kg of laundry
- Washable up to 95°C
- 100% polyester



Protective ironing cloth

Iron protector plate

Ironing board cover

Replacement pad for ironing board

Roller cover for ironing machines



Universal Stand with Base Division for Washing Machine and Dryer

Washable until	no specifications
Length	25 cm
Width	12,9 cm

- Particularly good sliding capacity thanks to PTFE surface
- The special arrangement of the steam outlet holes results in an even steam distribution
- The iron and the additional iron sole form a double layer which results in a particularly even heat distribution. Sensitive cloths such as synthetic materials, silk, velvet, etc. can easily be ironed also with higher temperature
- No pressing cloth required, glossy effects are avoided
- Protects the iron sole against dirt
- A retaining spring makes perfect hold on irons possible
- Material: aluminium coated with PTFE (polytetrafluoroethylene C2F4)
- Colour: silver



Iron Protection Cloth, kit of 2 pcs.

Washable until	60 °C
Length	60 cm
Width	40 cm

- Prevents the formation of shiny patches and ensures gloss-free creases
- Textile imprints and designs are protected
- 100% polyester grid bordered with cotton bias band



Protective ironing cloth

Iron protector plate

Ironing board cover

Replacement pad for ironing board

Roller cover for ironing machines

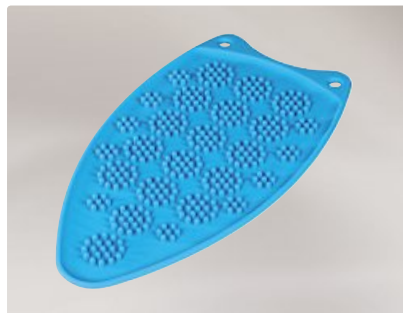

Silicone Iron Mat

Material	Silicone
Colour	Blue

- Silicone mat (heat-resistant up to 250°C) with anti-slip naps for all common irons
- Durable, flexible mat with a trendy design, prevents scratches on the sole as well as burn marks on the cover or tabletop
- Simply lay the mat on the ironing board cover
- Non-slip mat that prevents the iron from falling over
- Two suspension eyes for compact storage
- Easy to clean under running water or in the dishwasher

50		CB	111355	
4 047443 246356				

- Protective ironing cloth
- Iron protector plate
- Ironing board cover**
- Replacement pad for ironing board
- Roller cover for ironing machines



"Easy Glider" Ironing Board Cover

- Suitable for all irons
- Also for ironing boards with steam generator or integrated steam exhaust
- Cotton cover with a PU foam pad (thickness: 2 mm)
- Made in Germany (manufactured in accordance with Öko Tex standard 100)
- Fine surface texture for the best gliding ability
- Durable and long lasting
- Very good steam permeability
- Coloured imprint: "Vita"
- Suitable for ironing board surfaces of up to S (123 x 38 cm), M (127 x 40 cm), L (127 x 43 cm)
- Cord and "Easy Snap" stretching assistance

S (123 x 38 cm)		110933
20	PO	4 047443 008923
[Barcode]		

M (127 x 40 cm)		110934
20	PO	4 047443 008930
[Barcode]		

L (127 x 43 cm)		110935
20	PO	4 047443 008947
[Barcode]		



"High Speed" Ironing Board Cover

- Suitable for all irons
- Also for ironing boards with steam generator or integrated steam exhaust
- Cotton cover with a PU foam pad (thickness: 2 mm)
- The back metallization of the fabric reflects the iron heat and provides for a double-sided iron effect
- Repeated ironing over the silicone sliding strip cleans and smoothes the iron sole, resulting in the sole sliding much more easily over your clothing etc.
- Made in Germany (manufactured in accordance with Öko Tex standard 100)
- Durable and long lasting
- Very good steam permeability
- Coloured imprint: "Strips"
- Suitable for ironing board surfaces of up to S (128 x 38 cm), M (127 x 40 cm), L (127 x 43 cm)
- Cord and "Easy Snap" stretching assistance

S (128 x 38 cm)		110936
20	PO	4 047443 008954
[Barcode]		

M (127 x 40 cm)		110937
20	PO	4 047443 008961
[Barcode]		

L (127 x 43 cm)		110938
20	PO	4 047443 008978
[Barcode]		

Protective ironing cloth

Iron protector plate

Ironing board cover

Replacement pad for ironing board

Roller cover for ironing machines



Replacement Pad for Ironing Boards, universal, S-L

Material	Polyester
Length	125 cm
Width	43 cm

- Can easily be trimmed to size to fit the shape of any ironing board
- Extra thick pad, approx. 5.0 mm
- Necessary for all ironing boards



Protective ironing cloth

Iron protector plate

Ironing board cover

Replacement pad for ironing board

Roller cover for ironing machines



Universal Roller Cover for Electric Ironers

- Suitable for all ironers with a roller width of 85 cm
- Particularly durable cotton fabric
- Permeable to steam
- Long lasting
- Cords on both sides for fixing on the roller
- Dimensions: W 92 x L 80 cm
- Washable up to 60°C



- Thermometer
- Household filter
- Special lamp
- Water filter
- Hose connector



Digital Refrigerator/Freezer Thermometer

Display	Digital
Material	Plastic
Measuring Range	-30 °C up to +70 °C
Resolution	0.1 °C

- A correct internal temperature keeps food fresh longer and limits/prevents bacterial growth
- Holder for standing or hanging the thermometer up or for attaching it by means of a magnet
- The large digital display (50 x 20 mm) makes it easy to read off the temperature
- The temperature can be displayed in Celsius or Fahrenheit
- With a button for switching the thermometer on and off
- Size: 69 x 42 mm

111357

10	CB
----	----

4 047443 181534



Refrigerator/Freezer Thermometer, digital

Display	Digital
Material	Plastic
Measuring Range	-30 °C up to +30°C
Resolution	0.1 °C

- Correct internal temperature keeps food fresh longer and limits/prevents bacterial growth
- Easy attachment and removal by means of a hook and loop tape (adhesive attachment on the back of the thermometer)
- Large digital display for easy reading
- The temperature can be displayed in °C or Fahrenheit
- Data memory for max./min. temperature
- Dimensions: 5 x 5 cm

110823

6	BC
---	----

4 047443 005021

Lighting
Coffee & Tea
Household goods & Decoration
Small household appliances
Cleaning & Care
Energy & Technology
Accessories for household appliances

Accessories for household appliances

...	Washing & drying	Ironing	Refrigerating & freezing	Stove & glass ceramic hob	...
-----	------------------	---------	--------------------------	---------------------------	-----



Refrigerator/Freezer Thermometer, analogue

Display	Analogue
Material	Plastic
Measuring Range	-35 °C up to +40 °C
Resolution	1 °C

- Correct internal temperature keeps food fresh longer and limits/prevents bacterial growth
- Colour scale for easy reading



Refrigerator/Freezer Thermometer, round

Display	Analogue
Material	Plastic
Measuring Range	-30 °C up to +50 °C
Resolution	1 °C

- Correct internal temperature keeps food fresh longer and limits/prevents bacterial growth
- Colour scale for easy reading
- The thermometer can be stuck on (adhesive pad on the back) or hung in on an appropriate place



Freezer Thermometer

Display	Analogue
Material	Plastic
Measuring Range	-40 °C up to +30 °C
Resolution	1 °C

- Temperatures of -18°C enable long imperishability of food without the addition of preservatives
- Correct internal temperature prevents unnecessary energy consumption and saves energy costs
- Colour scale for easy reading
- Hook and eye for easy attachment



- Thermometer
- Household filter**
- Special lamp
- Water filter
- Hose connector



Activated Carbon Refrigerator Filter

Size	120 x 105 x 20 mm
Filter Type	Odour Filter
Usage	Fridge

- With activated charcoal (stops smells and takes up unwanted smells)
- Hang up in suitable place
- Can be used for approx. 3 to 4 months

110824

6	BC	
140 x 230		

4 047443 005038

- Thermometer
- Household filter
- Special lamp**
- Water filter
- Hose connector



Bulb for Cooling Appliances, 15W, E14, pear-shaped, clear

Bulb for Cooling Appliances, 25W, E14, pear-shaped, clear

Angle of Radiation	360 °
Can be Dimmed	✓
Colour Temperature	2700 K
Design	Pear Shape
Nominal Service Life	1000 h
Operating Position	360 °
Optimal Ambient Temperature	no specifications
Socket	E 14
Temperature Range	no specifications
Diameter	26 mm
Height	55 mm
Energy Efficiency Class	E (Scale from A++ to E, Optimum Value: A++)
Household room illumination	-
Lamp Current	no specifications
Nominal Light Output	90 lm
Mains Frequency	50 Hz
Nominal Power Consumption	15 W
Operating Voltage	230 V
Weighted Energy Consumption	15 kWh/1000h
Light Colour	Warm White
Especially Suited for	Cooling Appliances & Freezers, Bottle Coolers

Angle of Radiation	360 °
Can be Dimmed	✓
Colour Temperature	2700 K
Design	Pear Shape
Nominal Service Life	1000 h
Operating Position	360 °
Optimal Ambient Temperature	no specifications
Socket	E 14
Temperature Range	no specifications
Diameter	26 mm
Height	55 mm
Energy Efficiency Class	E (Scale from A++ to E, Optimum Value: A++)
Household room illumination	-
Lamp Current	no specifications
Nominal Light Output	160 lm
Mains Frequency	50 Hz
Nominal Power Consumption	25 W
Operating Voltage	230 V
Weighted Energy Consumption	25 kWh/1000h
Light Colour	Warm White
Especially Suited for	Cooling Appliances & Freezers, Bottle Coolers

112443

10	BC
90 x 180	4 047443 290304

112444

10	BC
90 x 180	4 047443 290168



LED Bulb for Cooling Appliances, 2.5W, E14, neutral white

Angle of Radiation	140°
Can be Dimmed	no specifications
Colour Temperature	4000 K
Design	Pear Shape
Nominal Service Life	25000 h
Operating Position	360°
Optimal Ambient Temperature	25 °C
Socket	E 14
Temperature Range	no specifications
Diameter	25 mm
Height	60 mm
Energy Efficiency Class	A+ (Scale from A++ to E, Optimum Value: A++)
Household room illumination	-
Lamp Current	28 mA
Nominal Light Output	180 lm
Mains Frequency	50 Hz
Nominal Power Consumption	2.5 W
Operating Voltage	230 V
Weighted Energy Consumption	2.5 kWh/1000h
Light Colour	no specifications
Especially Suited for	Cooling Appliances & Freezers, Bottle Coolers

- With an overall length of just 60 mm, this bulb fits into practically every refrigerator or freezer
- Also ideal for bottle coolers, sewing machines, orientation and night lights for which only small bulbs can be used
- Operating temperature: -20°C to +40°C



Thermometer
Household filter
Special lamp
Water filter
Hose connector



US Fridge Water Filter Cartridge for Bauknecht, Whirlpool etc.

Brand 1	Bauknecht
Usage	Side by Side Fridge

- The external filter cleans the tap water from rust, chlorine, sediments and suspended solids - for water/ice cube dispensers
- Ensures optimum water quality and considerably improved taste of drinking water and ice cubes
- Reduces chlorine contents, unpleasant smells and water impurities
- Very easy to install (is simply screwed in the filter head)
- According to the EU guideline 89/109EEC, the filter can come into contact with food
- Including a label to note the installation date/the date of change
- Suitable for: universal filters, suitable for external water filter kits (e.g. Xavax 110889)
- Technical details:
 - Filter type: activated carbon filter
 - Max. flow rate: 1.9 l/m
 - Max. pressure: 8.27 bars
 - Max. temperature: 37.8° Celsius
 - Life: 6 months / 1500 l





US Fridge Water Filter Cartridge for Samsung, G.E., LG, Liebherr

Brand 1	G. E.
Usage	Side by Side Fridge

- The filter cleans the tap water from rust, chlorine, sediments and suspended solids - for water/ice cube dispensers
- Ensures optimum water quality and considerably improved taste of drinking water and ice cubes
- Reduces chlorine contents, unpleasant smells and water impurities
- Very easy to install (is simply screwed in the filter head)
- According to the EU guideline 89/109EEC, the filter can come into contact with food
- Including a label to note the installation date/the date of change
- Suitable for: Samsung (WFS100, EF9603), G.E. (GXRTQR, QXITQR, GXITQ), LG (9808, BL 9303), Liebherr (SBS7052-4)
- Technical details:
 - Filter type: activated carbon filter
 - Max. flow rate: 2.8 l/m
 - Max. pressure: 8.62 bars
 - Max. temperature: 37.8° Celsius
 - Life: 6 months / 5670 l



Water Connection Set for US Refrigerators

Brand 1	no specifications
Usage	Side by Side Fridge

- Contains all parts needed for installation
- Quick-fit clamps enable you to install and remove pipes and connections without additional tools
- Consists of: 6 m water pipe (food safe) and a 5-part connector and connection set
- The retaining rings provide additional safety of the connection system
- According to the EU guideline 89/109EEC, the set can come into contact with food



- Thermometer
- Household filter
- Special lamp
- Water filter
- Hose connector**



T-Piece Angle Stop Valve 3/8" on 1/4" John Guest Connector

Nominal Diameter/mm 1	1/4" (DN:8), 13,5 mm
Nominal Diameter/mm 2	3/8" (DN:10), 17,2 mm
Nominal Diameter/mm 3	3/8" (DN:10), 17,2 mm
Material	Brass/Plastic
Maximum Temperature	no specifications
Outside Diameter	no specifications

- T-piece as a branch for subsequent mounting on an already existing angle valve or combo angle valve
- Allows water connection (on the branch) of coffee machines, table water devices, water-processing units and water filters by means of an additional pipe
- Can e.g. be used for water/filter connections or extensions to US side-by-side refrigerators
- The device connection uses the Speedfit™ system for plastic lines
- Quick mounting and demounting by means of plastic line to the refrigerator, tools are not required
- The supplied retaining ring provides additional safety and prevents the plastic line from being unlocked accidentally
- The device connection can be closed separately without interrupting the water flow for the other kitchen use

6 BC 111387
90 x 230 4 047443 301857

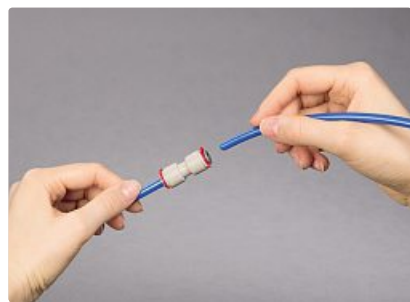

Straight Connector for Plastic Pipes, 1/4"

Nominal Diameter/mm 1	1/4" (DN:8), 13,5 mm
Nominal Diameter/mm 2	1/4" (DN:8), 13,5 mm
Nominal Diameter/mm 3	no specifications
Material	Plastic
Maximum Temperature	no specifications
Outside Diameter	18 mm

- E.g. for using with water/filter connections or for extensions on US side-by-side refrigerators
- Speedfit™ system for quickly mounting and removing the pipes and connections without tools
- Retaining rings provide additional safety of the connecting system and prevent the pipes from being unlocked accidentally
- Tested in accordance with the EU guideline 89/109EEC, can therefore be used for food and drinking water applications as well as for water treatment
- Also ideal for air and vacuum applications

8 BC 111388
90 x 145 4 047443 301383

...

Washing & drying

Ironing

Refrigerating & freezing

Stove & glass ceramic hob

...

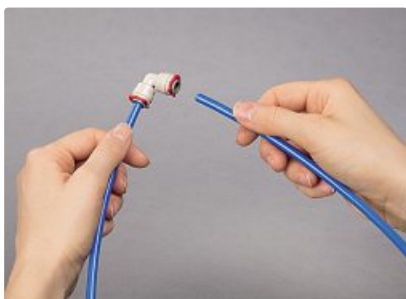

Angle Connector for Plastic Pipes, 1/4"

Nominal Diameter/mm 1	1/4" (DN:8), 13,5 mm
Nominal Diameter/mm 2	1/4" (DN:8), 13,5 mm
Nominal Diameter/mm 3	no specifications
Material	Plastic
Maximum Temperature	no specifications
Outside Diameter	no specifications

- E.g. for using with water/filter connections or for extensions on US side-by-side refrigerators
- Speedfit™ system for quickly mounting and removing the pipes and connections without tools
- Retaining rings provide additional safety of the connecting system and prevent the pipes from being unlocked accidentally
- Tested in accordance with the EU guideline 89/109EEC, can therefore be used for food and drinking water applications as well as for water treatment
- Also ideal for air and vacuum applications

111389



- Special lamp
- Scraper
- Replacemant Blade
- Cleaning Cloth
- Baking Tray
- Roasting/Baking Dish
- Chopping Board
- Induction Hob Adapter
- Backing/Roast Thermometer
- Lubricant



Oven Bulb, 15W, 300°, E14, pear-shaped, clear

Angle of Radiation	no specifications
Can be Dimmed	✓
Colour Temperature	2700 K
Design	Pear Shape
Nominal Service Life	1000 h
Operating Position	360°
Optimal Ambient Temperature	no specifications
Socket	E 14
Temperature Range	Up to 300°C
Diameter	no specifications
Height	50 mm
Energy Efficiency Class	E (Scale from A++ to E, Optimum Value: A++)
Household room illumination	-
Lamp Current	no specifications
Nominal Light Output	85 lm
Mains Frequency	50 Hz
Nominal Power Consumption	15 W
Operating Voltage	230 V
Weighted Energy Consumption	15 kWh/1000h
Light Colour	Warm White
Especially Suited for	Oven, Grill, Steamer, Clothes Dryer

- Heat-resistant up to 300° Celcius



Oven Lamp, 25W; 300°, E14, pear-shaped, clear

Angle of Radiation	360°
Can be Dimmed	✓
Colour Temperature	2700 K
Design	Pear Shape
Nominal Service Life	1000 h
Operating Position	360°
Optimal Ambient Temperature	300°C
Socket	E 14
Temperature Range	Up to 300°C
Diameter	26 mm
Height	58 mm
Energy Efficiency Class	F (Scale from A++ to E, Optimum Value: A++)
Household room illumination	-
Lamp Current	109 mA
Nominal Light Output	80 lm
Mains Frequency	50 Hz
Nominal Power Consumption	25 W
Operating Voltage	230 V
Weighted Energy Consumption	25 kWh/1000h
Light Colour	Warm White
Especially Suited for	Oven, Grill, Steamer, Clothes Dryer

- Heat-proof up to 300° Celcius
 - Pear-shaped incandescent lamp
 - Bulb diameter: 26 x 58 mm
 - Clear
 - 25 W; E 14; voltage: 230 V



Accessories for household appliances

...	Washing & drying	Ironing	Refrigerating & freezing	Stove & glass ceramic hob	...
-----	------------------	---------	--------------------------	---------------------------	-----



Oven Bulb, 40W, 300°, E14, drop-shaped, frosted

Angle of Radiation	360°
Can be Dimmed	✓
Colour Temperature	2700 K
Design	Pear Shape
Nominal Service Life	1000 h
Operating Position	360°
Optimal Ambient Temperature	no specifications
Socket	E 14
Temperature Range	Up to 300°C
Diameter	no specifications
Height	74 mm
Energy Efficiency Class	E (Scale from A++ to E, Optimum Value: A++)
Household room illumination	-
Lamp Current	no specifications
Nominal Light Output	400 lm
Mains Frequency	50 Hz
Nominal Power Consumption	40 W
Operating Voltage	230 V
Weighted Energy Consumption	40 kWh/1000h
Light Colour	Warm White
Especially Suited for	Oven, Grill, Steamer, Clothes Dryer

- Heat-resistant up to 300° Celcius
- High light efficiency



Oven Bulb, 25W, 300°, E27, drop-shaped, clear

Angle of Radiation	360°
Can be Dimmed	✓
Colour Temperature	2700 K
Design	Pear Shape
Nominal Service Life	1000 h
Operating Position	360°
Optimal Ambient Temperature	no specifications
Socket	E 14
Temperature Range	Up to 300°C
Diameter	no specifications
Height	76 mm
Energy Efficiency Class	E (Scale from A++ to E, Optimum Value: A++)
Household room illumination	-
Lamp Current	no specifications
Nominal Light Output	180 lm
Mains Frequency	50 Hz
Nominal Power Consumption	25 W
Operating Voltage	230 V
Weighted Energy Consumption	25 kWh/1000h
Light Colour	Warm White
Especially Suited for	Oven, Grill, Steamer, Clothes Dryer

- Heat-resistant up to 300° Celcius



Halogen Oven Lamp 10W, 450°, G4, clear

Angle of Radiation	360°
Can be Dimmed	✓
Colour Temperature	2900 K
Design	Base Pin
Nominal Service Life	2000 h
Operating Position	360°
Optimal Ambient Temperature	450 °C
Socket	G 4
Temperature Range	Up to 450°C
Diameter	12 mm
Height	37 mm
Energy Efficiency Class	D (Scale from A++ to E, Optimum Value: A++)
Household room illumination	-
Lamp Current	84 mA
Nominal Light Output	120 lm
Mains Frequency	AC Voltage
Nominal Power Consumption	10 W
Operating Voltage	12 V
Weighted Energy Consumption	10.6 kWh/1000h
Light Colour	Warm White
Especially Suited for	Oven, Grill, Steamer, Clothes Dryer

- Heat-proof up to 450° Celcius
- Low-voltage pin base with reinforced base pins



112441

10	BC
90 x 180	
4	047443 290281



112442

10	BC
90 x 180	
4	047443 290298



110516

10	BC
90 x 155	
4	047443 002389

- Special Bulb
- Scraper**
- Replacemant Blade
- Cleaning Cloth
- Baking Tray
- Roasting/Baking Dish
- Chopping Board
- Induction Hob Adapter
- Backing/Roast Thermometer
- Lubricant



Special Glass Scraper for Glass Ceramic Cooking Surfaces

Material	Metal
Safety Lock	✓
Usage	Glass Ceramic

- Glass scraper in first equipment quality, specially developed for glass ceramic hobs
- Also removes colour or residues of stickers on glass, tiles, etc.
- When not in use, the blade can easily be retracted (protective function)
- Ergonomically shaped grip, can be hung up
- The blade can easily be replaced (replacement blades item no.: 00111096)
- Dimensions of the metal housing: 138 x 46 mm

111010

12	BC	4 047443 015969
93 x 232		

Lighting

Coffee & Tea

Household goods & Decoration

Small household appliances

Cleaning & Care

Energy & Technology

Accessories for household appliances

- Special Bulb
- Scraper
- Replacement Blade**
- Cleaning Cloth
- Baking Tray
- Roasting/Baking Dish
- Chopping Board
- Induction Hob Adapter
- Backing/Roast Thermometer
- Lubricant

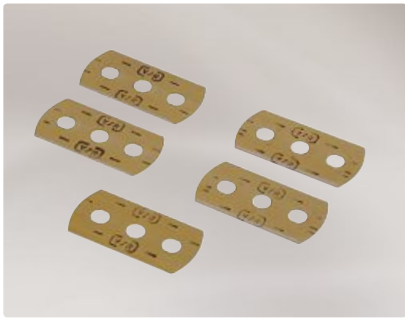

Replacement Blades for Glass Scraping Tool for Glass Ceramic Hobs

Anzahl Klingen	5
Usage	Ceramic Stove Top

- Replacement blades for Xavax glass scraping tool for glass ceramic hobs (item no. 00111010)
- Ground on both sides, thereby doubling the service life

		111096	
24	BC		
92 x 156			
		4	047443 082329

- Special Bulb
- Scraper
- Replacemant Blade
- Cleaning Cloth**
- Baking Tray
- Roasting/Baking Dish
- Chopping Board
- Induction Hob Adapter
- Backing/Roast Thermometer
- Lubricant



Special Glass Scraper for Glass Ceramic Cooking Surfaces

Material	15% Polyamide/85% Polyester
Washable	Up to 30°C
Width x Length	30 x 30 cm
Colour	Blue/Green/Red/Yellow
Number	4

- Removes dust, grease and dirt
- Excellent cleaning results with moist and dry cleaning
- One extra cloth for every surface, with different textures for more hygiene
- Can be used with or without cleaning agents
- Long service life

111360

6	CB	
---	----	--

- Special Bulb
- Scraper
- Replacemant Blade
- Cleaning Cloth
- Baking Tray**
- Roasting/Baking Dish
- Chopping Board
- Induction Hob Adapter
- Backing/Roast Thermometer
- Lubricant



Baking Tray, extendable, 3 cm lip

Extendable	✓
Border Height	3 cm
Depth	33 cm
Width	33 cm – 52 cm
Suitable for Dishwashers	-

- Particularly sturdy baking tray for all conventional ovens
- Ideal for baking pizzas, sheet cakes and other homemade or frozen dishes
- Continuously adjustable width (33 cm to 52 cm) to fit any oven size
- Safe and simple locking mechanism
- Due to the non-stick coating easy to clean with lukewarm water (no need to clean the tray in the dishwasher)



Pizza Crisp Plate

Extendable	-
Border Height	1,5
Depth	32,5
Width	32,5
Suitable for Dishwashers	✓

- Special baking tray for cooking pizza and other dishes that require an extra crispy crust
- Durable steel cooking tray with non-stick coating
- Also suitable for chips, croquettes and other frozen food that are prepared in the oven
- The tray ensures optimum even heat distribution
- Holes allow excess moisture to evaporate
- Non-stick coating: easy to clean with lukewarm water (cleaning in the dishwasher not necessary)
- Diameter: 32.5 cm (maximum pizza diameter: 31 cm)





Pizza Crisp Plate

Extendable	-
Border Height	3 cm
Depth	34 cm
Width	39 cm
Suitable for Dishwashers	-

- Durable steel cooking tray with non-stick coating
- Also suitable for chips, croquettes and other frozen food that are prepared in the oven
- The tray ensures even heat distribution
- Holes allow excess moisture to evaporate
- Non-stick coating: easy to clean with lukewarm water (cleaning in the dishwasher not necessary)



Special Bulb

Scraper

Replacemant Blade

Cleaning Cloth

Baking Tray

Roasting/Baking Dish

Chopping Board

Induction Hob Adapter

Backing/Roast Thermometer

Lubricant



Roasting/Oven Dish, round, stainless steel

Depth	6 cm
Height	6 cm
Width	32 cm
Suitable for Dishwashers	✓

- Practical oven dish for hot and cold dishes as well as for desserts
 - a- Extra deep (6 cm), therefore ideal for bakes, cakes, gratins, fried vegetables, etc.
- Suitable for quiches, pizzas and the like; can also be used for water baths for soufflés
- For preparing cold cuts, ice cream bombs, tiramisu, etc., also deep-frozen
- The right dish for presenting meals on a table
- Made of high-quality stainless steel (18/10)
- Meals can directly be cut in the dish



Accessories for household appliances

...

Washing & drying

Ironing

Refrigerating & freezing

Stove & glass ceramic hob

...



Baking/Oven Tray, stainless steel, 44.5 cm

Depth	6,5 cm
Height	37 cm
Width	44,5 cm
Suitable for Dishwashers	✓

- The tray can directly be inserted in the holders of the oven - an additional grille is no longer needed
- Extra deep (6,5 cm), therefore ideal for bakes, roasts, sheet cakes, gratins, fried vegetables, etc.
- Also suitable for preparing big fish, large poultry, haunches of venison, etc.
- With a volume of 8 litres ideal for parties or extended families
- Meals can directly be cut in the tray
- Made of high-quality stainless steel (18/10)
- For ovens with a width of 44.5 cm
- Also suitable for circulating air ovens
- Suitable e.g. for Miele, Whirlpool, Algor, Elco and Schaub Lorenz



Baking/Oven Tray, stainless steel, 46.5 cm

Depth	6,5 cm
Height	37 cm
Width	46,5 cm
Suitable for Dishwashers	✓

- Extra deep (6,5 cm), therefore ideal for bakes, roasts, sheet cakes, gratins, fried vegetables, etc.
- Also suitable for preparing big fish, large poultry, haunches of venison, etc.
- With a volume of 8 litres ideal for parties or extended families
- Meals can directly be cut in the tray
- Made of high-quality stainless steel (18/10)
- For ovens with a width of 46.5 cm
- Also suitable for circulating air ovens
- Suitable e.g. for Bosch, Siemens, Neff and Constructa





xavax[®]



Baking/Oven Tray, stainless steel

For direct insertion in the oven's rail
Extra-deep (6.5 cm) with a volume of 8 litres

Item No. 111504

Accessories for household appliances

...

Washing & drying

Ironing

Refrigerating & freezing

Stove & glass ceramic hob

...



Baking/Oven Tray, stainless steel, 42.5 cm

Depth	6,5 cm
Height	37 cm
Width	42.5 cm
Suitable for Dishwashers	✓

- Extra deep (6,5 cm), therefore ideal for bakes, roasts, sheet cakes, gratins, fried vegetables, etc.
- Also suitable for preparing big fish, large poultry, haunches of venison, etc.
- With a volume of 8 litres ideal for parties or extended families
- Meals can directly be cut in the tray
- Made of high-quality stainless steel (18/10)
- For ovens with a width of 42.5 cm
- Also suitable for circulating air ovens
- Suitable e.g. for AEG, Electrolux, Esco, Juno and Buderus

Special Bulb

Scraper

Replacement Blade

Cleaning Cloth

Baking Tray

Roasting/Baking Dish

Chopping Board

Induction Hob Adapter

Backing/Roast Thermometer

Lubricant

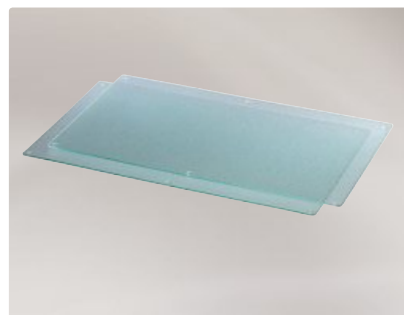

Multi Glass Cutting Board, pack of 2, "Clear" design, 52 cm x 30 cm

Depth	52 cm
Height Feet	2.5 cm
Width	30 cm

- Ideal for covering (completely/partly) the glass ceramic cooking surface
- Suitable for glass ceramic hobs with a width of 60 cm
- Upright positioning of the plate is possible, serves thus as protection against splashes
- Can also be used as serving plate for warm or cold meals
- Tempered glass (practically unbreakable)
- Heat-resistant
- Smell and dirt resistant
- Cut, scratch and shock resistant
- Dishwasher-safe
- Polished edges
- Each plate with four non-slip elastic feet (height: approx. 2.5 mm)



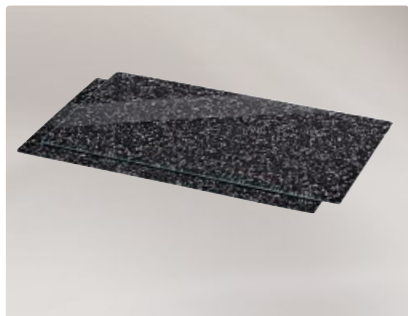

Multi Glass Cutting Board, pack of 2, "Granite" design, 52 cm x 30 cm

Depth	52 cm
Height	1.2 cm
Width	30 cm

- Ideal for covering (completely/partly) the glass ceramic cooking surface
- Suitable for glass ceramic hobs with a width of 60 cm
- Upright positioning of the plate is possible, serves thus as protection against splashes
- Can also be used as serving plate for warm or cold meals
- Tempered glass (practically unbreakable)
- Heat-resistant
- Smell and dirt resistant
- Cut, scratch and shock resistant
- Polished edges
- Each plate with six non-slip elastic feet (height: approx. 3 mm)



Glass Cutting Plate, pack of 2, "Granite" design, 52 cm x 38.5 cm

Depth	52 cm
Height	1.2 cm
Width	38,5 cm

- Ideal for covering glass ceramic hobs or as splash guard on a wall
- The glass cutting plates cover the complete hob thereby enlarging the kitchen surface; with a single plate, however, you can partly cover the hob and use it as a chopping board or storage place
- Suitable for glass ceramic hobs with a width of 77 cm
- Can also be used as a platter or server for warm and cold food
- Tempered safety glass
- Heat-resistant
- Odour and dirt-resistant
- Cut, scratch and shock-resistant
- Polished edges
- Each plate with six non-slip elastic feet (height: approx. 2,5 mm)

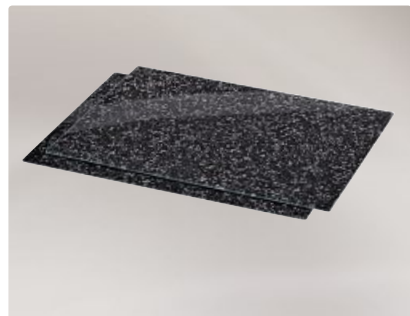

Glass Cutting Plate, pack of 2, "Granite" design, 52 cm x 40 cm

Depth	52 cm
Height	1.2 cm
Width	40 cm

- Ideal for covering glass ceramic hobs or as splash guard on a wall
- The glass cutting plates cover the complete hob thereby enlarging the kitchen surface; with a single plate, however, you can partly cover the hob and use it as a chopping board or storage place
- Suitable for glass ceramic hobs with a width of 80 cm
- Can also be used as a platter or server for warm and cold food
- Tempered safety glass
- Heat-resistant
- Odour and dirt-resistant
- Cut, scratch and shock-resistant
- Polished edges
- Each plate with six non-slip elastic feet (height: approx. 2,5 mm)



Accessories for household appliances

...

Washing & drying

Ironing

Refrigerating & freezing

Stove & glass ceramic hob

...



**Glass Cutting Plate, pack of 3,
"Granite" design, 52 cm x 30 cm**

**Multi Glass Cutting Plate, pack of 2,
"Spice" design, 52 cm x 30 cm**

Depth	52 cm
Height	1.2 cm
Width	30 cm

Depth	52 cm
Height	1.2 cm
Width	30 cm

- Ideal for covering glass ceramic hobs or as splash guard on a wall
- The glass cutting plates cover the complete hob thereby enlarging the kitchen surface; with a single plate, however, you can partly cover the hob and use it as a chopping board or storage place
- Suitable for glass ceramic hobs with a width of 90 cm
- Can also be used as a platter or server for warm and cold food
- Tempered safety glass
- Heat-resistant
- Odour and dirt-resistant
- Cut, scratch and shock-resistant
- Suitable for dishwashers
- Polished edges
- Each plate with six non-slip elastic feet (height: approx. 2,5 mm)

- Ideal for covering glass ceramic hobs or as splash guard on a wall
- The glass cutting plates cover the complete hob thereby enlarging the kitchen surface; with a single plate, however, you can partly cover the hob and use it as a chopping board or storage place
- Suitable for glass ceramic hobs with a width of 60 cm
- Can also be used as a platter or server for warm and cold food
- Tempered safety glass
- Heat-resistant
- Odour and dirt-resistant
- Cut, scratch and shock-resistant
- Polished edges
- Each plate with six non-slip elastic feet (height: approx. 2,5 mm)





Item No. 111374 /111375

Induction Hob Adapter Plate

Ideal for avoiding use of magnetic cookware on induction hobs
The adapter dissipates the heat from the cooker to pots, pans, etc.

- Special Bulb
- Scraper
- Replacemant Blade
- Cleaning Cloth
- Baking Tray
- Roasting/Baking Dish
- Chopping Board
- Induction Hob Adapter**
- Backing/Roast Thermometer
- Lubricant



Induction Hob Adapter Plate

Material	Metal
Diameter	19 cm

- Ideal for using non-magnetic cookware on induction hobs
- The adapter conducts heat from the stove to pots, pans, teakettles, roasting pans, etc.
- Suitable for dishes made from aluminium, stainless steel, glass, copper and ceramics
- Sandwich material consisting of stainless steel with an aluminium core
- For containers with a similar diameter, max. 19/23,5 cm wide
- A long, insulated handle facilitates using the induction hob adapter plate and prevents burns when the plate is lifted
- The plate is easy to clean under running water or in the dishwasher

19 cm		111374
6	CB	
4 047443		289100

23,5 m		111375
5	CB	
4 047443		289117

- Special Bulb
- Scraper
- Replacemant Blade
- Cleaning Cloth
- Baking Tray
- Roasting/Baking Dish
- Chopping Board
- Induction Hob Adapter
- Backing/Roast Thermometer**
- Lubricant



Digital Multi-Thermometer

Display	Digital
Measuring Range	-45°C to +200°C
Resolution	0.1°C
Usage	Drinking Temperature/ Roast Temperature

- For quick and easy recognition of the correct drinking temperature (e.g. wine or sparkling wine)
- With removable silicone fastener for storing and closing opened bottles
- For measuring the inside temperature of meals (cutting the foodstuffs up is not necessary)
- For exact (medium, well done) roasting, cooking and baking
- Quick, exact indication on the display (resolution: 0.1°C)
- Ideal for fish, meat and vegetables
- Food safe
- Battery (1.5V LR44) included in the delivery package
- With temperature table for different applications
- Baby food: 37.0°C
- Water for tea: 60-90°C
- Oil for roasting: 150-190°C
- Olive oil: up to 160°C
- Beef, medium: core temperature: 60-65°C
- Poultry: core temperature: 80-90°C
- Red wine, new/dry: 14-16°C

111014

6	CB	
---	----	--

4 047443 019622



Digital Multi-Thermometer

Display	Analogue
Measuring Range	Meat, 30°-100°C/ Oven 50°-250°C
Resolution	1°C
Usage	Oven/Roast Temperature

- 2in1 thermometer for controlling the cooking and oven temperature
- Needle 1 (red) measures the current oven temperature
- Needle 2 (black) measures the core temperature
- For exact (English, medium, well done) roasting, cooking and baking
- Ideal for fish, poultry, meat
- Food-safe
- Measuring range - oven: 50°C to 250°C
- Measuring range - meat/baked goods: 30°C to 100°C
- Size: Ø 73 mm
- Stainless steel 430, matt (18/0)

111018

6	CB	
---	----	--

4 047443 019929



Digital multi-thermometer

For measuring the core temperature of food,
food safe

Item No. 111014



Digital Meat Thermometer with timer, cable sensor

Display	Digital
Measuring Range	-10° - 250 °C / 14° - 482° F
Resolution	1 °C

- The stainless steel probe (160 mm) with 1 m heat-resistant cable allows you to measure the inside temperature of food - simply insert the probe
- Ideal for vegetables, roasts, cakes and steaks as well as for soups, wine, tea water, baby food and much more
- For controlling different cooking levels by setting a specific temperature: an alarm can prevent the set temperature to be exceeded, this prevents food from overcooking
- Can be used as a timer or thermometer, countdown and countup timer adjustable up to maximally 99 minutes and 59 seconds
- Suitable for continuous operation, e.g. for the complete roasting time (insertion sensor in the oven and measuring body outside)
- Sturdy housing can be attached in many positions, e.g. by a magnet, built-in suspension eye and stand



Digital Meat Thermometer with Timer, wireless sensor

Display	Digital
Measuring Range	-10° - 250 °C / 14° - 482° F
Resolution	1 °C

- Usage: Drinking Temperature/Oven/Roast Temperatur
- Preset core temperatures of beef, veal, hamburger, minced meat, pork, turkey, chicken, fish and lamb saved in the thermometer
- Temperature display in degrees Celsius and Fahrenheit
- For controlling different cooking levels: depending on the type of meat well, medium well, medium, medium rare and rare selectable
- Built-in timer up to 99 minutes: 59 seconds with alarm function as soon as the desired temperature has been achieved
- Displays the current temperature and desired temperature
- The removable temperature sensor allows measuring the inside temperature of food - simply by inserting the probe
- Receiver with a clip in mobile phone size, can easily be carried around in the household, range: 8 m to the base station
- Base station with LED indicator lamp serves as a radio transmitter and holder
- Display with orange LED backlight



Accessories for household appliances

...

Washing & drying

Ironing

Refrigerating & freezing

Stove & glass ceramic hob

...

Special Bulb

Scraper

Replacemant Blade

Cleaning Cloth

Baking Tray

Roasting/Baking Dish

Chopping Board

Induction Hob Adapter

Backing/Roast Thermometer

Lubricant



"OKS 371" Multipurpose Spray Oil for Kitchenware, 100 ml

Content	100 in ml
Usage	Universal

- Special spray oil that can be used as lubricant in kitchens, households, bathrooms and workshops
- Can be used for devices that come into contact with food, also usable as penetrating oil, preservative oil and service spray
- E.g. for ovens, baking trolleys, universal cutters, mixers, mixing rods, whisks, waffle irons, sandwich toaster and more
- Also usable for baking tins with a tension ring, cherry/plum stoners, pasta machines, food processor attachments and food processor accessories
- Ideal for all applications which allow lubricants to be rinsed off by cleaning and rinsing processes
- High effectiveness due to its excellent adhesion on all materials, forms a very effective lubricating film which displaces moisture and provides long-lasting protection
- Easy to use as specific points of lubrication can be sprayed
- Extremely high penetration ability, makes dissolve dirt and rust
- Hinges, mechanics and moving parts are kept movable
- Can operate in temperatures ranging from -10°C to +180°C
- Density (20 °C): 0.87g/ml

		111383	
6	BC		
91 x 230		4	047443 293862

- Exhaust air pipe

- Reducer

- Household filter

- Special lamp



**Aluminium Duct for Cooker Hoods,
150 mm**

Maximum Length	3 m
Colour	Silver

- Particularly long service life due to the use of high-quality aluminium
- Very flexible, therefore also suitable for small radii
- AL/A 3300 standard uni
- CIG 7129/92

		110834	
48	CB		
		4	047443 005137

Accessories for household appliances

...	Stove & glass ceramic hob	Extractor hood	Microwave	Vacuum cleaner
-----	---------------------------	----------------	-----------	----------------

Exhaust air pipe
Reducer
Household filter
Special lamp



**Reducer for Cooker Hood,
100-125 mm**

**Reducer for Cooker Hoods,
125-150 mm**

Material	Plastic
Colour	White

Material	Plastic
Colour	White

- Reduces the connection diameter from 125 to 100 mm

- Reduces the junction diameter from 150 to 125 mm

		111061	
10	PO		
		4	047443 037664

		110836	
10	PO		
		4	047443 005151

- Exhaust air pipe
- Reducer
- Household filter**
- Special lamp

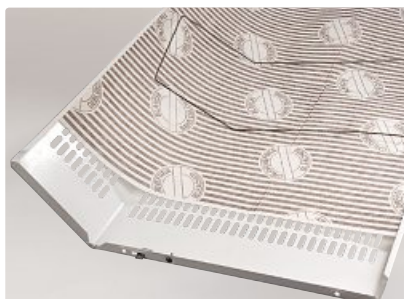

Flat Filter for Cooker Hoods, 2 pcs./set

Size	470 x 570 mm
Filter Type	Grease Trap
Usage	Fume Hood

- With saturation indicator (indicator colour discolours from grey-brown into red)
- Replace filter when the saturation indicator is red
- Can be individually cut to size
- Fire protection class according to ISO 9772 (UL 94 HBF)



High-Performance Activated Carbon Filter for Cooker Hoods

Size	470 x 570 mm
Filter Type	Odour Filter
Usage	Fume Hood

- Special honey-comb structure (holds approx. 400 g highly efficient activated charcoal)
- Thus 15x more filtration performance than standard universal filters
- Can be used for an extremely long period of time, up to 1 year without filter change
- Can be individually cut to size
- Fire protection class according to ISO 9772 (HBF)



Accessories for household appliances

...	Stove & glass ceramic hob	Extractor hood	Microwave	Vacuum cleaner
-----	---------------------------	----------------	-----------	----------------



Fleece Filter for Cooker Hoods, 2 pcs./set

Size	470 x 570 mm
Filter Type	Grease Trap
Usage	Fume Hood

- Special, particularly absorbent texture made of fibres
- can be individually cut to size

Activated Carbon Filter for Cooker Hoods, 2 pcs./set

Size	470 x 570 mm
Filter Type	Odour Filter
Usage	Fume Hood

- Special, particularly absorbent texture made of fibres
- Many odours are trapped to a large extent due to the addition of activated carbon
- Can be individually cut to size
- Fire protection class according to ISO 9772 (UL 94 HBF)

Universal Combination Filter for Deep Fryers

Size	330 x 296 mm
Filter Type	Grease Trap/Odour Filter
Usage	Deep Fryer

- One carbon smell filter and one fat filter with saturation indicator
- Can be individually cut to size (expensive filter cartridges do not have to be bought)
- Flat filter: fire protection class according to ISO 9772 (UL 94 HBF)
- Activated carbon filter: fire protection class according to ISO 9772 (HF1)





Fat/Activated Carbon Filter for Cooker Hoods, 2 pcs./set

Size	470 x 570 mm
Filter Type	Odour Filter
Usage	Fume Hood

- Set consisting of a carbon smell filter and a fat filter
- With saturation indicator (indicator colour discolours from grey-brown into red)
- Exchange filter when the saturation indicator is red
- Can be individually cut to size
- Fire protection class according to ISO 9772 (UL 94 HBF)
- Activated carbon filter: fire protection class according to ISO 9772 (HF1)

Exhaust air pipe

Reducer

Household filter

Special lamp



Halogen Bulb for Extractor Hoods, 25 W, tubular, clear, E14

Angle of Radiation	360 °
Can be Dimmed	✓
Colour Temperature	2700 K
Design	Tube
Nominal Service Life	2000 h
Operating Position	360 °
Optimal Ambient Temperature	25 °C
Socket	E 14
Temperature Range	no specifications
Diameter	26 mm
Height	80 mm
Energy Efficiency Class	D (Scale from A++ to E, Optimum Value: A++)
Household room illumination	-
Lamp Current	109 mA
Nominal Light Output	260 lm
Mains Frequency	50 Hz
Nominal Power Consumption	25 W
Operating Voltage	230 V
Weighted Energy Consumption	25 kWh/1000h
Light Colour	Warm White
Especially Suited for	Exhaust Hood

- A special halogen bulb has a longer service life than a normal special bulb
- Insensitive to vibrations
- Optimum light distribution



...

Stove & glass ceramic hob

Extractor hood

Microwave

Vacuum cleaner



Halogen Bulb for Extractor Hoods, 40 W, tubular, clear, E14

Angle of Radiation	360 °
Can be Dimmed	✓
Colour Temperature	2700 K
Design	Tube
Nominal Service Life	2000 h
Operating Position	360 °
Optimal Ambient Temperature	25 °C
Socket	E 14
Temperature Range	no specifications
Diameter	26 mm
Height	80 mm
Energy Efficiency Class	D (Scale from A++ to E, Optimum Value: A++)
Household room illumination	-
Lamp Current	174 mA
Nominal Light Output	490 lm
Mains Frequency	50 Hz
Nominal Power Consumption	40 W
Operating Voltage	230 V
Weighted Energy Consumption	40 kWh/1000h
Light Colour	Warm White
Especially Suited for	Exhaust Hood

- A special halogen bulb has a longer service life than a normal special bulb
- Insensitive to vibrations
- Optimum light distribution

		112438	
10	BC		
90 x 180			
		4	047443 290175

Microwave Bracket

Microwave Cover

Microwave Plate Set

Microwave-Safe Dishes

Microwave Box Set



Microwave Bracket, white

Microwave Bracket, silver

Max. B x T	40 x 50 cm
Maximum Load Carrying Capacity	30 kg
Colour	White

Max. B x T	40 x 50 cm
Maximum Load Carrying Capacity	30 kg
Colour	Silver

- Space-saving and easy mounting
- The width and depth can be adjusted
- Stamped-in hollows ensure secure positioning of the appliance
- Max. load capacity: 30 kg
- Max. width: 40 cm
- Max. depth: 50 cm

- Space-saving and easy mounting
- The width and depth can be adjusted
- Stamped-in hollows ensure secure positioning of the appliance
- Max. load capacity: 30 kg
- Max. width: 40 cm
- Max. depth: 50 cm



Accessories for household appliances

...

Stove & glass ceramic hob

Extractor hood

Microwave

Vacuum cleaner

Microwave Bracket

Microwave Cover

Microwave Plate Set

Microwave-Safe Dishes

Microwave Box Set



"Ergo Maxi" Microwave Cover

"Ergo 2" Microwave Cover

Temperature Range	-40°C to 120°C
Height	8.5 cm
Width	29 cm
Suitable for Dishwashers	✓

Temperature Range	-40°C to 120°C
Height	11 cm
Width	26 cm
Suitable for Dishwashers	✓

- Shortens cooking time by reducing the cooking space
- Contains all splashes
- Allows built up steam to be released
- Practical handle

- Shortens cooking time by reducing the cooking space
- Contains all splashes
- Allows built up steam to be released
- Practical handle for easily removing the cover from a dinner plate
- Odour-free and food-safe



Accessories for household appliances

...	Stove & glass ceramic hob	Extractor hood	Microwave	Vacuum cleaner
-----	---------------------------	----------------	------------------	----------------



"S-Capo" Microwave Cover

Temperature Range	-30°C to 110°C
Height	10.3 cm
Width	22 cm
Suitable for Dishwashers	✓

- Shortens cooking time by reducing the cooking space
- Contains all splashes
- Allows built up steam to be released
- Especially high, practical handle for easily removing the cover from a dinner plate
- Large handle and centred steam vents prevent burns when the cover is removed



"M-Capo" Microwave Cover

Temperature Range	-30°C to 110°C
Height	10.3 cm
Width	26 cm
Suitable for Dishwashers	✓

- Shortens cooking time by reducing the cooking space
- Contains all splashes
- Allows built up steam to be released
- Especially high, practical handle for easily removing the cover from a dinner plate
- Large handle and centred steam vents prevent burns when the cover is removed



"Basic" Microwave Cover

Temperature Range	-40°C to 120°C
Height	6.9 cm
Width	26 cm
Suitable for Dishwashers	✓

- Contains all splashes
- Shortens cooking time by reducing the cooking space
- Allows built up steam to be released
- Practical handle for easily removing the cover from a dinner plate



- Microwave Bracket
- Microwave Cover
- Microwave Plate Set**
- Microwave-Safe Dishes
- Microwave Box Set



Set of Microwave Plates, 3 parts

Suitable for Dishwashers	✓
Number of Plates	3

- Set consisting of three menu plates with matching lids
- Menu plate with three compartments for food
- Can be used for freezing prefabricated meals in portions
- If required, the portions can be defrosted and heated up immediately, there is no need to put the food in a separate box
- Shifted grips for easy opening
- Optimum microwave permeability

111513

4	CB	
---	----	--



"M-Capo" Microwave Cover

Shortens cooking time by reducing the cooking space
Contains all splashes

Item No. 111542

- Microwave Bracket
- Microwave Cover
- Microwave Plate Set
- Microwave-Safe Dishes**
- Microwave Box Set



Microwave Starter Kit, 4 pieces

Temperature Range	-40°C to 120°C
Suitable for Dishwashers	✓

- Comprises 2 boxes (1.0l, round; 2.0l, round), 1 microwave plate and 1 microwave hood (special grips for easy opening)
- Optimum microwave permeability
- Dimensions:
 - 1.0l box: 215 x 175 x 70 mm
 - 2.0l box: 215 x 175 x 125 mm
 - Microwave plate: 262 x 230 x 50 mm
 - Microwave hood: 290 x 88 mm

		110829
4	CB	
4 047443 005083		



Microwave Plate, separate with cover

Temperature Range	-20°C to 100°C
Suitable for Dishwashers	✓

- Menu plate with cover and three compartments for food (for appetizing separation of food)
- Cover with microwave valve and freezing marker (shifted grips for easy opening)
- Prefabricated meals can be frozen in portions
- If necessary, the portions can be defrosted and heated up immediately – putting them in another box is not necessary
- Resistant from -20° up to +100°C
- Best microwave permeability
- Dishwasher-safe
- Breakproof
- Non-odiferous and tasteless
- Food safe

		111043
12	CB	
4 047443 022653		

- Microwave Bracket
- Microwave Cover
- Microwave Plate Set
- Microwave-Safe Dishes
- Microwave Box Set**



"Round" Set of Microwave/Freezer Storage Containers, 2 pcs., turku./claret

Component	Microwave Container, 1l = 18 cm x 17 cm x 7 cm/ Microwave Container, 2l = 24 cm x 21 cm x 9 cm
-----------	---

- 2-part set for freezing, storing, heating up and serving meals
- Consisting of 2 containers with matching covers (Ø 24x9 cm and Ø 21x9 cm)
- The containers can be stacked in each other for space saving storage
- Microwave permeable
- Easy to open and close
- Plates can be transferred directly from freezer to microwave for defrosting or reheating, preventing the need to transfer to additional containers inbetween
- Cover with overpressure valve for use in microwaves
- Breakproof
- Non-odiferous and tasteless
- Food-safe
- Suitable for dishwashers
- Suitable for a temperature range from -20°C to 100°C

111525

8	CB	
---	----	--

Accessories for household appliances

...	Stove & glass ceramic hob	Extractor hood	Microwave	Vacuum cleaner
-----	---------------------------	----------------	-----------	----------------

Overview of vacuum cleaner bags

Manufacturer	Original name of the manufacturer	XAVAX		SWIRL	MENALUX AB 2005	Clean Bag - Scan Part	Aurora	Scanor
AEG	AEG: 28; Electrolux: E 53, E 150, E 160, E 180, E 181, 185, 190, 200; Hoover: AE 23; Progress: P 60, PA 16; Unifit: uni 154, 187, 239; Volta: V 31;	AE 01	110002	A 07	1000 (DCT 153)	121 AEG 10; M 122 AEG 16	MAE 2012-350504	AE 21; AE 22
AEG	AEG: 22, 23, 24, 25, 26; Hoover: A 324; Progress: PA 10, 11, 13, 14;	AE 02	110005	A 08; (A 09)	1001 (DCT 91)	120 AEG 3; 109 AEG 2; 108 AEG 1; M 108 AEG 15	MAE 2010-350509; AE 2008-350004;	AE 08
AEG	AEG: S-Bag, 200, 201, 205, 206, 210, 212 (Öko); Electrolux: E 15, E 18, E 40, E 41, E 51, E 54, E 55, E 59, E 200, E 201, E 202, E 203, E 205, E 210; S-Bag; Philips: HR 6999, Sydney, S-Bag, FC 8021 > 8023; Progress: PA 20; PE 5, 9, 15; PP 6; Volta: S-Bag; E 200; Zanussi: S-Bag;	AE 03	110006	PH 86; PH 96; (E 82; E83; VO 75)	1800 (DCT 197)	186 ELE 6; M 187 ELE 11; 186 PHI 5; M 186 PHI 9	MEL 2068-350501; 350603; 350605;	EL 86; EL 87+; PH 86
AEG	AEG: 5; Electrolux: E 51 N, E 65; Elram: Str. 5; Hoover: AE 24; Progress: P 58, P 59, PA 17, PE 10; Unifit: uni 179; Volta: V 34;	AE 05	110026	A 06	1002 (DCT 196)	122 AEG 11; M 106 AEG 17	MEL 2063-350507;	AE 06
AEG	AEG: 50; AFK: ST SB 45; CTC/Clatron: SSB 05; Grundig: E; Kärcher: 6.905-891; Nilfisk: 22.300.500; 78.600.900; Progress: PA 24, PSE 2; Samsung: VP-95B;	AE 06	110033	Y 05; Y 45; Y 99; Y 105;	1840; 3502P;	105 AFK3; 199 AFK 2; 101 DAE 1; M 101 DAE 3;	MNI 2160-350145;	
AEG	AEG: 11, 13; Vampyr 400-499; Hoover: AE 18; Progress: PA 9;	AE 07 P	110027	A 18	1003 (DCT 53)	118 AEG 8	AE 2004-350002	AE 18
AEG	AEG: 51, Smart 460, Smart 470, Smart 485; Delta: KS 1202; Electrolux: E 59; FIF: KS 1202, 1204; Primera: EVC 175; Progress: P 61; Unifit: uni 231;	AE 09	110072	Y 204	1803 P (CT 236)	109 AFK 7	HO 2120-350151	138 HOO
Bosch/Siemens	Bosch: G, G XL; Siemens: G, G XL; Hoover: S 340; Kärcher: 6.414-824; Krups: 923; Progress: PS 15; Severin: SB 9028	BS 01	110001	S 67	2000 (DCT 39)	167 SIE 7; M 167 SIE 16; M 170 SIE 20;	MSI 2204-350502	SI 62; SI 65; SI 67; SI 68; SI 73+
Bosch/Siemens	Bosch: D, E, F, G XXL, H; Siemens: D, E, F, G XXL, H; Kärcher: 6.904-329; Progress: PS 8, 12, 14, 18; PSE 4; Unifit (Homespares): uni 78, uni 155, uni 234;	BS 02	110004	S 62; S 73; (S 68; Y 94)	2000	106 AFK 4; 162 SIE 2; 168 SIE 8; M 169 SIE 19; M 162 SIE 15; M173 SIE 23;	MSI 2204-350502	SI 73+
Bosch/Siemens	Bosch: Typ A, B, C, BBZ 23 AF, BBZ 4 AF1; Krups: 926; Siemens: Typ A, B, C; Progress: PS 11, 13, 16;	BS 03	110013	S 64; (S 66)	2900 (DCT 51)	164 SIE 4; 166 SIE 4; 168 SIE 8	SI 2210-350093; SI 2214-350095;	SI 64; SI 66;
Bosch/Siemens	Bosch: BBZ 52 AFP., Typ P; Siemens: VZ 52 AFP, Typ P; Progress: PS 22;	BS 04	110016	S 71	2002 (CT 223)	172 SIE 16; M 172 SIE 22	MSI 2222-350510	SI 72
Bosch/Siemens	Bosch: BBZ 71 AF K, Typ K; Siemens: VS 01 G 000 - VS 01 G 9999, VZ 71 AF K, Typ K; Progress: PS 20;	BS 05	110035	S 70	2001 (DCT 222)	171 SIE 15; M 171 SIE 21	MSI 2020-350506	SI 71+
Bosch/Siemens	Bosch Gr.: BHZ 4 AF1; Typ S; Siemens Gr.: VZ 92 S 40, Typ S; Hoover: S 319; Progress: PS 19;	BS 06 P	110052	S 69	2070 P (CB 61)	170 SIE 14		
EIO	EIO: 9, 9a, 9b, 14, 20, 26; ewt: 54590102; Hoover: EN 46; Progress: PL 4; Unifit: uni 149;	EL 01	110021	EIO 80; DD 80;	6002 (DCT 132)	180 EIO 2; M 180 EIO 5	MA 4100-350127	M 180 EIO
Electrolux	Electrolux: E 5, 44, 49, 49N; Progress: P 57, PE 7; Tornado: T 185; Volta: V 27;	EL 01	110034	E 84	1200 (CT 185)	189 ELE 9; M 189 ELE 13;	MEL 2065-350027	EL 89
Hoover	Hoover: H 20, H 20 A, H 20 S; Progress: PH 3, PH 23;	HO 03 P	110050	H 37	3050 P (CD 68)	120 HOO 10		

Accessories for household appliances

...	Stove & glass ceramic hob	Extractor hood	Microwave	Vacuum cleaner
-----	---------------------------	----------------	-----------	----------------

Manufacturer	Original name of the manufacturer	XAVAX	SWIRL	MENALUX AB 2005	Clean Bag - Scan Part	Aurora	Scanor
Industry	Fakir (nilco): 2204805, 3214810, 3270805, 3288810; Hoover: H33, H34; Kärcher: 1.081-121, 1.081-400, 6.904-143, 6.904-162, 6.904-164, 6.904-167, 6.904-322, 6.904-324; Progress: PF 04;	IND 10	110098	F 95; K 223; K 224; K 225; Uni 10; VAC 121	3585 (CS 51); 4885 (CS 46)		
Industry	AEG: 30; Aqua Vac: 90517, 90519; Bosch: BBZ 21 AF, BMZ 21 AF, Typ W, X; Electrolux: E 26, E 47, E47 N, E48 Flexio; Fakir (nilco): 22 70 810, 26 01 805, 26 06 805; 26 06 806; 31 09 810; Hoover: H 2, H 13, H 15, H 16, H 26A, H 31, H 39, RO 50, U 100; Kärcher: 6.904-263, 6.904-288, 6.904-289, 6.904-290, 6.959-130, 6.969-310, Moulinex: R 24.01; Progress: P 53, P 64, P 80, PH 2, PH 14, PN 2, PR 5, PVA 20; proVAC: 120555; Rowenta: ZR-82, ZR-815, ZR-817; Siemens: 460448, VZ 92351, Typ W, X; Thomas: 20, 26, 200, 201, 300, 820, 920, 787 100; 787 101; 787 102, 787 105, 787 106; Volta: V 25 F;	IND 20	110099	Uni 20; R 23 (E/P 46; H 21; H 35; K 222; E 20; MX 89; VAC 120)	1220 P; 1286 P; 1770 (CS 32); 1810; 2585 (CS 04); 3086 (CS 13); 4686 P;	118 MOU 12; 121 HOO 7; 123 ROW 3; 121 VAC 2; 190 ELE 10;	RO 2199-350192 123 ROW; RO 23
Industry	Aqua Vac: 90532, 90535, 90661; Einhell: 23.511.70; Hoover: H 45, RO 49; Kärcher: 6.904-051, 6.904-090, 6.904-210; Progress: PR 5, PVA 30; proVAC: 5700404; Rowenta: ZR-804; Thomas: 310, 350, 826, 926, 787 103, 787 104, AT 380;	IND 30	110100	Uni 30; R 24; VAC 130;	1769 P; 5885 P;	124 ROW 4; 120 VAC 1;	EL 2070-350168; EL 83
Kärcher	Kärcher: 6.904-059, 6.904-097, 6.904-311, 6.906-097; Columbus: 20208430; Sebo 36, 46, 360, 460	KÄ 01 P	110063	K 210; X 210;	4887 P	103 KAR 3	
Miele	Miele: F, J, M = 4; Hoover: MI 37; Progress: PM 8, PM 10, PM 11;	MI 01	110003	M 50; (M 51; M 53; Y 90)	3100 (DCT 61/22)	152 MIE 1; 150 MIE 2; M 157 MIE 15; 155 MIE 9;	MMI 2130-350505 MI 50; MI 52; MI 53; MI 55; MI 57
Miele	Miele: G, H, N, U; Hoover: H 22, H 22 A, H 30, H 30+, H 30 S, H 52, H 60, MI 41; Progress: PH 21, PH 22, PM 7, 9, 12;	MI 02	110010	M 40; M 49; (M 54; M 55); H 41; (H 38);	3101 (DCT 22); 3001 (CT 176 / DCT 184)	149 MIE 5; 153 MIE 3; M 158 MIE 16; 156 MIE 10; 122 HOO 11; 137 HOO 13; M 137 HOO 15	MMI 2132-350128; MHO 2115-350129 MI 56; MI 58; HO 37
Miele	Miele S 140-157, S160-169, Typ K; Hoover: MI 38; Progress: PM 1, PM 1 micro;	MI 03	110031	M 52	3170 (DCB 60)	154 MIE 4	
Miele	Miele S 125-138, B; Hoover: MI 32; Progress: PM 6;	MI 04 P	110039	M 48	3171 P (CB 13)	148 MIE 8	
Moulinex	Krups: 997; Moulinex: 250, A 82, B 45, L85, W 51 > 56, W 84; Hoover: MX 59, MX 60; MX 91; Progress: PX 4, PX 5, PX 6;	MO 01	110023	MX 87; (MX 88; MX 91)	2100 (DCT 75); 2105 (CT 127); 2185;	109 MOU 2; 188 MOU 4;	MO 2140-350063 MO 09
Nilfisk	Nilfisk: 816 200 00, 820 950 00; 916 200 00; GS 80; Hoover: N 1; Progress: PN 1;	NI 01	110061	N 71	3285 P (CS 02)	181 NIL 1	MNI 2154-350070 NI 81
Nilfisk	Nilfisk: 147 0286 500, 147 0416 500, 223 595 00, 816 460 00, 818 460 00; 223 595 00; Hoover: N 4; Team ST 16; Progress: PN 3;	NI 02	110062	N 72; N 73	3201 (CT 135)	200 NIL 2; M 201 NIL 3	MNI 2156-350511 NI 00; NI 01
Omega	Omega Carat; Effect; Power; Power 2000; Bomann: B27, B28; CB 922, 923, 924, 939, 944; Fakir: 24 17 805, 27 74 809; Progress: PL 5;	OM 02 P	110020	X 28	6100 P (CT 137)	103 BOM 3	
Omega	Omega: Contur Serie, 15585-340.014.0;	OM 03 P	110049	O 87	6672 P (CB 31B)	193 OME 3	

Accessories for household appliances

...	Stove & glass ceramic hob	Extractor hood	Microwave	Vacuum cleaner
-----	---------------------------	----------------	-----------	----------------

Overview of vacuum cleaner bags

Manufacturer	Original name of the manufacturer	XAVAX		SWIRL	MENALUX AB 2005	Clean Bag - Scan Part	Aurora	Scanor
Panasonic	Omega: Buggy, Format; Fakir/Nilco: 20 01 805, 20 11 805, 20 47 805; Hoover: Sprint, H 58, H 63, H 64; Severin: SB 9015;	OM 06	110055	X 351; (X 350)	6601 P (CT 235); 1005, 1803 P;	138 HOO 14; 199 FAK 8; 200 FAK 10; M 138 HOO 17;		
Kärcher	Panasonic: MC-E 881-886, 959-989, 1000-1099, C-2, C-2 E, C-5C, C-7, C-15C, C-17H, C-20 E; Hoover: PN 20; Nilfisk: 82017201, 82222800, 82222900, 82367810; Progress: PC 1, PC 2, PC 3;	PA 02	110054	PC 87; PC 89; (PC83; PC 90);	2201 (CT 84); 2702 (DCT 28)	105 PAN 5; 114 PAN 6; 115 PAN 7; M 105 PAN 8;	PA 2162-350073; MPA 2164-350508; PA 2166-350075;	PA 04; PA 05; PA 09; PA 14;
Philips	Philips: HR 6938, HR 6939, HR 6983, Oslo; Hoover: PS 26; Progress: PP 4;	PH 01	110015	PH 84 (Y31)	3200 (DCT 57)	184 PHI 4; M 184 PHI 8	MPH 2176-350079	PH 84
Progress	Progress: P 45; Electrolux: E 10, E 42; Volta: V 3;	PR 03 P	110056	(E/P 43; VO 70)	1201 P (CT 65)	182 PRO 9	EL 2054-350020	EL 82
Universal	"Universalbeutel - passend für nahezu alle Staubsauger - der Originalflansch wird vom alten Staubsaugerbeutel entfernt und muss auf der Klebefläche des Universalbeutels fixiert werden; Rowenta: WB 105, 108; Unifit: uni SOS;"	SOS 01	110096		FL 180; SOS ST;		351031	
Rowenta	Rowenta: ZR-0026, ZR-76, ZR-765; Fakir/Nilco Gr.: 21 18 805, 24 01 805, 24 05 805, 24 10 805, 24 12 805, 24 14 804, 24 14 805, 24 91 804, 27 05 804; Hoover: H 35, RO 41; Progress: PF 11, PR 1;	RO 01	110009	R 22 (F 89; F98; Y 103)	2500 (DCT 35); 4608 P	104 ALA 1; 122 ROW 2; 188 FAK 9; 189 FAK 1	WI 2240-350101; GS 2404-350116	102 ZEL; RO 22;
Rowenta	Rowenta: Artec RO 300-340, Balloon, Tonixo RS 700-799, ZR-45, ZR-455; Hoover: RO 56; Progress: PR 12;	RO 04	110040	R 29	2103 (CT 187)	143 ROW 9	RO 2193-350085	122 ROW; RO 43
Rowenta	Rowenta: ZR-0015, ZR-0028;	RO 06	110094	R 36	2306	147 ROW 13; M 147 ROW 15;		
Vorwerk	Vorwerk VK 118-122, Gr.: VK 120/121; Hoover: W 10; Progress: PO 3;	VO 01 P	110012	V 62	6970 P	162 VOR 2		
Vorwerk	Vorwerk Tiger VK 250, 251, 252, Gr.: VK 250, 251, 252 Hoover: V 4; Progress: PO 2;	VO 02 P	110017	V 63	6900 P (CT 119)	163 VOR 3	VO 4210-350120	VO 63
Vorwerk	Vorwerk Kobold, VK 130, System 131, Gr.: FP 131	VO 03 P	110011	V 64	6971 P (CB 57)	164 VOR 5		
Vorwerk	Vorwerk Kobold VK 135, Gr.: FP 135;	VO 04 P	110028	V 65	--	165 VOR 6		
various brands	Xavax Sammelnr. u.a. für: Bomann CB 949, 966, 969, 991; Clatronic/CTC: SSB 101, 201, BS 1232/33; Daewoo: SB 100; RC 705 Electrolux E 62, E 66, ES 66; Fakir/Nilco: 20 06 805, 24 12 805, 24 22 805, 27 22 805; Nilfisk: 22.380.900; GM 60, 100; Hoover: DW 1, GL 3, H 66; Kärcher: 6.969-001; Philips: Geneva, HR 6995; Progress: P 55, 59, 120, PD 1, PT 3; Samsung: VP 50, 77, 78, VT 89; Severin: SB 9017, 9026, 9517; Unifit: uni 104, 152, 178, 183, 184, 197, 207, 209, 218, 227, 236, 238, 242; Dirt Devil: R1, R3, R4, R9 - Xavax nicht antiinfective	XA 01	110007	DD 93; DD 293; Y 12; Y 50; Y 91; Y 93; Y 95; Y 101; Y 191; Y 201; Y 293	1900 (DCT 120/CT 218); 1940; 3502 P; 5100; 4000 (DCT 146)	001 TAU 2; 107 AFK 5; 110 AFK 10; 150 PRO 12; 188 FAK 9; 188 PHI 7; 193 AFK 1; 193 ALA 2;	MGS 2408-350118; MNI 2158-350137; PH 2177-350123;	DA 01; M 101 DAE; PH 88; WI 06
various brands	Xavax Sammelnr. u.a. für: Bomann: B 52; Electrolux: E 67; Ideline: 749-404; Hoover: H 55, MC 4; Progress P 56, 67, PSE 1; Rowenta: ZR 0017; Severin SB 9022, 9030; Tchibo/TCM: 201 506; unifit: 176, 182, 243;	XA 02	110018	Y 98; (Y 198; Y 298)	1750 (DCT 210)	100 DAE 2; 198 AFK 1; 001 TAU 1; M 198 AFK 1;	MIL 2324-350113	AF 02

Accessories for household appliances

...	Stove & glass ceramic hob	Extractor hood	Microwave	Vacuum cleaner	
-----	---------------------------	----------------	-----------	----------------	--

Manufacturer	Original name of the manufacturer	XAVAX		SWIRL	MENALUX AB 2005	Clean Bag - Scan Part	Aurora	Scanor
various brands	Xavax Sammelnr. u.a. für: Fakir/ Nilco: 20 06 805; Progress: PSA 2; LG: TB 36;	XA 03 P	110030	Y 61; Y 64;	1840 (DCT 183); 4000; 4902	101 DAE 1	MWI 2256-350108; LG 2212-350133	HU 06; LG 30; WI 09; 107 AFK;
various brands	Xavax Sammelnr. u.a. für: Alaska BS 1230; Daewoo: SB 70, 80, 200, VCB 300; Hoover DW 2; Progress: PD 2; Unifit: uni 31;	XA 04 P	110044	Y 100	4200 (DCT 179)	100 DAE 2; M 100 DAE 4;	MDA 2500-350121	DA 00
various brands	Xavax Sammelnr. u.a. für: Bomann CB 950, 993; Clatronic/CTC Gr.: SSB 30; LG Electronic TB 33, 34, 39, 43; Progress: PG 1; Rowenta ZR 0039;	XA 05	110045	Y 30; Y 230	4900 (DCT 172)	130 LG 1; 193 ALA 2; M 130 LG 6;	MGS 2400-350114	LG 30; PA 05;
various brands	Xavax Sammelnr. u.a. für: Bomann: B43; Clatronic: SSB 104; HBH: 749-4036; Ideline: 749-403; Progress: PT 2; Trisa: C 009;	XA 06	110032	Y 104	4600 (DCT 211)	102 BOM 2; M 102 BOM 6;	IL 2320-350111	ID 02
Zelmer	Zelmer Elf, Flip, Gr.: 49.4000, 49.402; Fakir/Nilco Gr.: 20 22 804, 20 26 804, 20 60 805, 20 26 805;	ZE 01	110046	Z 111	5803 P (CT 205)	111 ZEL 5; M 111 ZEL 8		
Zelmer	Zelmer Serie Meteor 1010-1199; Admiral, Allergo, Compact, Eco; Electrolux: ES 101;	ZE 02	110047	Z 110	5802 (CT 174)	110 ZEL 4		
Zelmer	Zelmer Orion Serie 1500, 2500, GR.: 49.4100, 49.4120; Fakir/ Nilco Gr.: 20 01 803, 20 18 805, 20 19 804, 20 19 805;	ZE 04	110014	Z 113	6001 P; 7002 P	112 ZEL 6; 198 FAK 3;		

Not a comparison of the quality – the types listed can be used as replacements for the original bag based on their size and connections. Errors excepted; subject to changes.

Vacuum Cleaner Bag

Vacuum cleaner extracted air cleaner

Vacuum cleaner engine filter

HEPA Filter

Vacuum Cleaner Nozzle

Vacuum Cleaner Replacement Part



AE 01 Vacuum Cleaner Bags

Exhaust Air/Motor Filter	Trimmed to Size
Number of Vacuum Cleaner Bags	4
Holding Plate Width x Height	112 x 90 mm

- Certified: filter performance, suction power and operating life tested by TÜV (German technical inspection association)
- MicroMultiFleece with a filtration of 99.9%, prevents germ formation and mould growth; the multi-layer structure effectively traps fine dust and allergens like pollen and mites
- With dust seal
- Highly loadable plastic connection
- Suitable for AEG vacuum cleaner bags with the designation: Size 28, ACE... Serie, CE Serie, (Öko)-Vampyr 5000 series
- Suitable for Electrolux vacuum cleaner bags with the designation: E 53
- Suitable for Progress vacuum cleaner bags with the designation: P 60
- Suitable for Volta vacuum cleaner bags with the designation: V 31
- Suitable for Hoover vacuum cleaner bags with the designation: AE 23
- Also suitable for different vacuum cleaner bags from: Alfatec, Baur Versand, Kingclean, Lindhaus, Lloyds, Mio Star, Privileg, Satrap, Singer, SMC, Thomas, Tornado, Zanussi



AE 02 Vacuum Cleaner Bags

Exhaust Air/Motor Filter	Trimmed to Size
Number of Vacuum Cleaner Bags	4
Holding Plate Width x Height	98 x 115 mm

- Certified: filter performance, suction power and operating life tested by TÜV (German technical inspection association)
- MicroMultiFleece with a filtration of 99.9%, prevents germ formation and mould growth; the multi-layer structure effectively traps fine dust and allergens like pollen and mites
- With dust seal
- Suitable for AEG vacuum cleaner bags with the designation: Size: 22-26
- Suitable for Progress vacuum cleaner bags with the designation: PA 10-14
- Also suitable for different vacuum cleaner bags from: Hanseatic, Privileg, Singer, Thomas



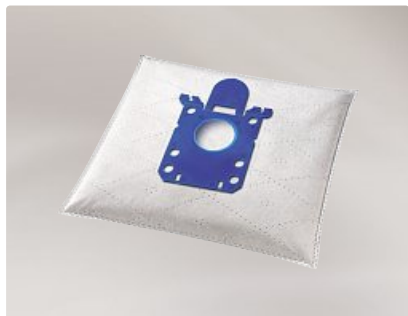

AE 03 Vacuum Cleaner Bags

Exhaust Air/Motor Filter	Trimmed to Size
Number of Vacuum Cleaner Bags	4
Holding Plate Width x Height	123 x 99 mm

- Certified: filter performance, suction power and operating life tested by TÜV (German technical inspection association)
- MicroMultiFleece with a filtration of 99.9%, prevents germ formation and mould growth; the multi-layer structure effectively traps fine dust and allergens like pollen and mites
- With dust seal
- Highly loadable plastic connection
- Replacement for AEG vacuum cleaner bags with the designation: S-Bag; 200/201/205/206/210
- Replacement bag for AEG/Electrolux vacuum cleaner series with the designation: ULTRA ONE, OXYGEN+, OXY3SYSTEM™, SYSTEM_PRO, ULTRA SILENCER™, MAXIMUS, VIVA CONTROL, VIVA QUICKSTOP und AIR MAX S-Bag; E 55
- Replacement bag for Philips vacuum cleaners with the designation: FC8200 - FC8219, FC8380 - FC8399, FC8400 - FC8499, FC8600 - FC8649, FC9000 - FC9099, FC9100 - FC9199, HR8300 - HR8349, HR8368 - HR8378, HR8500 - HR8599, Gr.: HR 6999; Sydney; FC 8021; FC 8022/01; S-Bag
- Replacement for Electrolux vacuum cleaner bags with the designation: Size: E 12; E 15; E 18; E 40; E 41; E 54a; E 200; E 202; E 203; E 205; S-Bag
- Replacement for Progress vacuum cleaner bags with the designation: PA 20; PE 5,9,15; PP 6
- Replacement for Volta vacuum cleaner bags with the designation: S-Bag; E 200
- Also suitable for different vacuum cleaners from: Hanseatic, Hugin, Mio-Star, Privileg



AE 05 Vacuum Cleaner Bags

Exhaust Air/Motor Filter	Trimmed to Size
Number of Vacuum Cleaner Bags	4
Holding Plate Width x Height	112 x 90 mm

- Certified: filter performance, suction power and operating life tested by TÜV (German technical inspection association)
- MicroMultiFleece with a filtration of 99.9%, prevents germ formation and mould growth; the multi-layer structure effectively traps fine dust and allergens like pollen and mites
- With dust seal
- Highly loadable plastic connection
- Suitable for AEG vacuum cleaner bags with the designation: Size: 5
- Suitable for Electrolux vacuum cleaner bags with the designation: Size: E 51; E 65
- Suitable for Progress vacuum cleaner bags with the designation: Size: P 58, P 58a, P 59, PA 17, PE 10
- Suitable for Volta vacuum cleaner bags with the designation: V 34
- Suitable for Elram vacuum cleaner bags with the designation: Str. 5
- Suitable for Hoover vacuum cleaner bags with the designation: AE 24
- Also suitable for different vacuum cleaner bags from: Alfatec; Baur Versand, De Sina; Hugin, Lloyds, Mio Star, Privileg, Seaway, Singer, Thomas, Tornado, Ufesa, Zanussi

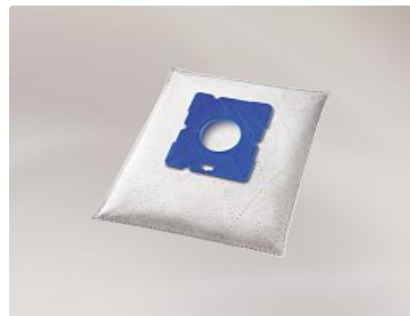

AE 06 Vacuum Cleaner Bags

Exhaust Air/Motor Filter	Trimmed to Size
Number of Vacuum Cleaner Bags	4
Holding Plate Width x Height	110 x 100 mm

- Certified: filter performance, suction power and operating life tested by TÜV (German technical inspection association)
- MicroMultiFleece with a filtration of 99.9%, prevents germ formation and mould growth; the multi-layer structure effectively traps fine dust and allergens like pollen and mites
- With dust seal
- Highly loadable plastic connection
- Replacement for the following original vacuum cleaner bags:
- AEG vacuum cleaner bags with the designation: Gr. 50
- AFK - Germatic vacuum cleaner bags with the designation: STSB 45
- CTC/Clatronic vacuum cleaner bags with the designation: SSB 05
- Grundig vacuum cleaner bags with the designation: E
- Kärcher vacuum cleaner bags with the designation: 6.905-891
- Nilfisk vacuum cleaner bags with the designation: 22.300.500; 78.600.900;
- Progress vacuum cleaner bags with the designation: PA 24; PSE 2;
- Samsung vacuum cleaner bags with the designation: VP-95 B
- Severin vacuum cleaner bags with the designation: SB 9095



Accessories for household appliances

...

Stove & glass ceramic hob

Extractor hood

Microwave

Vacuum cleaner



AE 07 P Vacuum Cleaner Bags

Exhaust Air/Motor Filter	Trimmed to Size
Number of Vacuum Cleaner Bags	5
Holding Plate Width x Height	211 x 105 mm

- Made of special paper
- With dust seal
- Paper especially suited to the vacuum cleaner
- Suitable for AEG vacuum cleaner bags with the designation: Size: 11 - 13
- Suitable for Vampyr vacuum cleaner bags with the designation: 400-499
- Suitable for Hoover vacuum cleaner bags with the designation: AE 18
- Suitable for Progress vacuum cleaner bags with the designation: PA 9
- Also suitable for different vacuum cleaner bags from: Privileg; Hanseatic; Neufunk



AE 09 Vacuum Cleaner Bags

Exhaust Air/Motor Filter	Trimmed to Size
Number of Vacuum Cleaner Bags	4
Holding Plate Width x Height	112 x 92 mm

- Certified: filter performance, suction power and operating life tested by TÜV (German technical inspection association)
- MicroMultiFleece with a filtration of 99.9%, prevents germ formation and mould growth; the multi-layer structure effectively traps fine dust and allergens like pollen and mites
- Suitable for:
 - AEG vacuum cleaner bags with the designation: size 51
 - AEG devices with the designation: Smart 460; Smart 470; Smart 485; VOZ Y
 - Delta devices with the designation: KS 1202
 - FIF devices with the designation: KS 1202; KS 1204
 - Primera devices with the designation: EVC 175
 - Electrolux devices with the designation: E 59
 - Progress devices with the designation: P 61



BS 01 Vacuum Cleaner Bags

Exhaust Air/Motor Filter	Trimmed to Size
Number of Vacuum Cleaner Bags	4
Holding Plate Width x Height	100 x 109 mm

- Certified: filter performance, suction power and operating life tested by TÜV (German technical inspection association)
- MicroMultiFleece with a filtration of 99.9%, prevents germ formation and mould growth; the multi-layer structure effectively traps fine dust and allergens like pollen and mites
- With dust seal
- Highly loadable plastic connection
- Replacement bag for Bosch vacuum cleaners with the designation: BSG L 2 Move 1 - 4, BSG L 30000 - 39999, BSG L 40000 - 49999, BSG L 60000 - 69999, BSG L 70000 - 79999 formula hygienixx, G, G XL
- Replacement bag for Siemens vacuum cleaner series with the designation: VS 04 G..., VS 05 G..., VS 06 G..., VS 32..., VS 33..., VS 42..., VS 44..., VS 5 A..., VS 5 B..., VS 5 C..., VS 5 D..., VS 5 E..., VS 5 KA..., VS 61 A 1..., VS 63 A 00, VS 63 A 9... with basket, VS 7 C..., VS 7 D... mit Korb, VS 9 A..., VS Z 3..., VS Z 4..., G, G XL
- Hoover devices with the designation: S 340
- Kärcher devices with the designation: 6.414-824
- Krups devices with the designation: 926
- Progress devices with the designation: PS 15
- Also suitable for different vacuum cleaners from: Hanseatic, Hoover, Kärcher, Lloyds, Privileg, Profilo, Progress, Protos, Severin, Tech Line, Tornado, Ufesa, Wigo, Wilfa





Vacuum cleaner bags

For powerful suction capacity
Extremely durable plastic connector

Item No. 110001

Accessories for household appliances

...	Stove & glass ceramic hob	Extractor hood	Microwave	Vacuum cleaner
-----	---------------------------	----------------	-----------	----------------



BS 02 Vacuum Cleaner Bags

Exhaust Air/Motor Filter	Trimmed to Size
Number of Vacuum Cleaner Bags	4
Holding Plate Width x Height	98 x 85 mm

- Certified: filter performance, suction power and operating life tested by TÜV (German technical inspection association)
- MicroMultiFleece with a filtration of 99.9%, prevents germ formation and mould growth; the multi-layer structure effectively traps fine dust and allergens like pollen and mites
- With dust seal
- Highly loadable plastic connection
- Replacement for Bosch/Siemens vacuum cleaner bags with the designation: D, E, F, G, XL, G XXL, G XXL Plus, H
- Replacement bag for Bosch vacuum cleaner series with the designation: BSG 70000 - 79999, BSG 50000 - 59999
- Replacement bag for Siemens vacuum cleaner series with the designation: VS 07 G..., VS 5..., VS 7..., VS 10..., VS 69..., VS Z 5..., VS Z 6..., D, E, F, G XXL, H
- Replacement bag for Kärcher vacuum cleaner series with the designation: 6.904-329
- Replacement bag for Progress vacuum cleaner series with the designation: PS 8, 12, 14, 18, PSE 4
- Replacement bag for Severin vacuum cleaner series with the designation: SB 9028
- Also suitable for different vacuum cleaner bags from: Conti Talento, De Sina, Germi, Hot Point, Kärcher, Krups, Lloyds, Privileg, Protos, Severin, SP



BS 03 Vacuum Cleaner Bags

Exhaust Air/Motor Filter	Trimmed to Size
Number of Vacuum Cleaner Bags	4
Holding Plate Width x Height	111 x 111 mm

- Certified: filter performance, suction power and operating life tested by TÜV (German technical inspection association)
- MicroMultiFleece with a filtration of 99.9%, prevents germ formation and mould growth; the multi-layer structure effectively traps fine dust and allergens like pollen and mites
- With dust seal
- Suitable for Bosch vacuum cleaner bags with the designation: Size: BBZ 23 AF/ BBZ 25 AF; BBZ 3 AF 1 Type C; BBZ 3 AF 2 Type B; BBZ 4 AF 1; BBZ 4 AF 2 Type A
- Suitable for Siemens vacuum cleaner bags with the designation: Size: VZ 92 C 91; VX 9091; VZ 9291 Type C; VZ 92 B 91; VZ 92911; VZ 51 AF ABC; Type A/B/C
- Suitable for Siemens vacuum cleaner bags with the designation: 926
- Suitable for Siemens vacuum cleaner bags with the designation: PS 11, 13, 16
- Also suitable for different vacuum cleaner bags from: Girmi, Krups, Privileg



BS 04 Vacuum Cleaner Bags

Exhaust Air/Motor Filter	Trimmed to Size
Number of Vacuum Cleaner Bags	4
Holding Plate Width x Height	102 x 12.2 mm

- Certified: filter performance, suction power and operating life tested by TÜV (German technical inspection association)
- MicroMultiFleece with a filtration of 99.9%, prevents germ formation and mould growth; the multi-layer structure effectively traps fine dust and allergens like pollen and mites
- With dust seal
- Replacement for Bosch vacuum cleaner bags with the designation: Type P; BBZ 41 FP; BBZ 52 AFP 1 - 2; BSH 82010, BSG 8 Pro 1 bis 999, BSG 80000 bis 89999
- Replacement for Siemens vacuum cleaner bags with the designation: Type P; VZ 52 AFP; VS 08 G 1000 bis 2999
- Replacement for Siemens vacuum cleaner bags with the designation: PS 22
- Also suitable for different vacuum cleaner bags from: Lloyds, Progress, Privileg





BS 05 Vacuum Cleaner Bags

Exhaust Air/Motor Filter	Trimmed to Size
Number of Vacuum Cleaner Bags	5
Holding Plate Width x Height	211 x 105 mm

- Certified: filter performance, suction power and operating life tested by TÜV (German technical inspection association)
 - MicroMultiFleece with a filtration of 99.9%, prevents germ formation and mould growth; the multi-layer structure effectively traps fine dust and allergens like pollen and mites
 - With dust seal
 - Suitable for Bosch vacuum cleaner bags with the designation: Type K; BBZ 71 AFK
 - Suitable for Siemens vacuum cleaner bags with the designation: Typ K; VZ 71 AFK, VS 01 G 000 - VS 01 G 9999
 - Suitable for Siemens vacuum cleaner bags with the designation: PS 20
- Also suitable for different vacuum cleaner bags from: Lloyds, Privileg, Profilo, Ufesa



BS 06 P Vacuum Cleaner Bags

Exhaust Air/Motor Filter	Trimmed to Size
Number of Vacuum Cleaner Bags	5
Holding Plate Width x Height	100 x 80 mm

- Made of special paper
- With dust seal
- Paper especially suited to the vacuum cleaner
- Suitable for Bosch vacuum cleaner bags with the designation: Size: BHZ 4 AF1; type S
- Suitable for Siemens vacuum cleaner bags with the designation: Size: VZ 92 S 40; type S
- Suitable for Hoover vacuum cleaner bags with the designation: S 319
- Suitable for Progress vacuum cleaner bags with the designation: PS 19
- Also suitable for different vacuum cleaner bags from: Privileg



EI 01 Vacuum Cleaner Bags

Exhaust Air/Motor Filter	Trimmed to Size
Number of Vacuum Cleaner Bags	4
Holding Plate Width x Height	88 x 102 mm

- Certified: filter performance, suction power and operating life tested by TÜV (German technical inspection association)
- MicroMultiFleece with a filtration of 99.9%, prevents germ formation and mould growth; the multi-layer structure effectively traps fine dust and allergens like pollen and mites
- With dust seal
- Suitable for EIO vacuum cleaner bags with the designation: Size: Gr: 9 a/b/c; 14; 20; 26
- Suitable for Chromex vacuum cleaner bags with the designation: Size: CH: 261, 263, 266, 269, 271, 274, 277, 286, 954, 955;
- Suitable for Hoover vacuum cleaner bags with the designation: EN 46
- Also suitable for different vacuum cleaner bags from: Alaska; Amadis; Arc En Ciel; Ariete; Aslo; Aspiwash; Betron; Blue Air; Brinkmann; Chromex; Ecotronic; Elexavox; Elin; ewt; Fagor; Fersen; Fust; Grandius; Hanseatic; Imetec; Kaisui; Kalorik; Kneissel; Lloyds; Lordson; Masterkraft; M-Tec; Neufunk; Novamatic; Privileg; Profectis; Profimaster; Rotel; Saivod; Selectline; Solac; Tchibo/TCM; Tornado; Triumph; Trisa; Ufesa; Unicline; White & Brown; Zanker



Accessories for household appliances

...

Stove & glass ceramic hob

Extractor hood

Microwave

Vacuum cleaner



EL 01 Vacuum Cleaner Bags

Exhaust Air/Motor Filter	Trimmed to Size
Number of Vacuum Cleaner Bags	5
Holding Plate Width x Height	213 x 120 mm

- MicroMultiFleece with a filtration of 99.9%, prevents germ formation and mould growth; the multi-layer structure effectively traps fine dust and allergens like pollen and mites
- With dust seal
- Suitable for Electrolux vacuum cleaner bags with the designation: Size: E 44 and E 49
- Suitable for Volta vacuum cleaner bags with the designation: Size: V 27
- Suitable for Progress vacuum cleaner bags with the designation: Size: P 57
- Also suitable for different vacuum cleaner bags from: Hugin; MioStar; Privileg; Tornado



HO 03 P Vacuum Cleaner Bags

Exhaust Air/Motor Filter	Trimmed to Size
Number of Vacuum Cleaner Bags	4
Holding Plate Width x Height	135 x 98 mm

- Made of special paper
- With dust seal
- Paper especially suited to the vacuum cleaner
- Suitable for Hoover vacuum cleaner bags with the designation: Size: H 20; H 20 a; H 20S
- Suitable for Progress vacuum cleaner bags with the designation: PH 3; PH 23
- Also suitable for different vacuum cleaner bags from: Hanseatic; Privileg; Pure Power



"IND 10" Vacuum Cleaner Bag

Exhaust Air/Motor Filter	Trimmed to Size
Number of Vacuum Cleaner Bags	4
Holding Plate Width x Height	135 x 98 mm

- MicroMultiFleece with a filtration of 99.9%, prevents germ formation and mould growth; the multi-layer structure effectively traps fine dust and allergens like pollen and mites
- With dust closure
- Suitable for the majority of canister vacuum cleaners with a 10 l dust container
- Suitable for Aqua Vac vacuum cleaner bags with the designation: Az 91 71 675; Multi Pro, Pro 1250, 1400, 1500
- Suitable for Goblin vacuum cleaner bags with the designation: FAM Serie Power VAC
- Suitable for Tchibo vacuum cleaner bags with the designation: TCM 05 591



Accessories for household appliances

...	Stove & glass ceramic hob	Extractor hood	Microwave	Vacuum cleaner
-----	---------------------------	----------------	-----------	----------------



"IND 20" Vacuum Cleaner Bag

Exhaust Air/Motor Filter	Not needed
Number of Vacuum Cleaner Bags	3
Holding Plate Width x Height	130 x 100 mm

- MicroMultiFleece with a filtration of 99.9%, prevents germ formation and mould growth; the multi-layer structure effectively traps fine dust and allergens like pollen and mites
- With dust closure
- Suitable for the majority of canister vacuum cleaners with a 20 l dust container



"IND 30" Vacuum Cleaner Bag

Exhaust Air/Motor Filter	Not needed
Number of Vacuum Cleaner Bags	2
Holding Plate Width x Height	130 x 100 mm

- MicroMultiFleece with a filtration of 99.9%, prevents germ formation and mould growth; the multi-layer structure effectively traps fine dust and allergens like pollen and mites
- With dust closure
- Suitable for the majority of canister vacuum cleaners with a 30 l dust container



MI 01 Vacuum Cleaner Bags

Exhaust Air/Motor Filter	Trimmed to Size
Number of Vacuum Cleaner Bags	4
Holding Plate Width x Height	93 x 84 mm

- Certified: filter performance, suction power and operating life tested by TÜV (German technical inspection association)
- MicroMultiFleece with a filtration of 99.9%, prevents germ formation and mould growth; the multi-layer structure effectively traps fine dust and allergens like pollen and mites
- With dust seal
- Highly loadable plastic connection
- Replacement for Miele vacuum cleaner bags with the designation: Size F/J/M; (bottom side = 3 rollers)
- Replacement bag for Miele vacuum cleaner series with the designation: S 4, S 241 bis S 256 i, S 290 bis S 299 i, S 300i bis S 399i, S 4000 bis S 4999, S 500 bis S 599, S 700 bis S 799, Cat & Dog 4000, Hybrid, Parket & Co 4000, Tango und Tango Plus



Accessories for household appliances

...

Stove & glass ceramic hob

Extractor hood

Microwave

Vacuum cleaner



MI 02 Vacuum Cleaner Bags

Exhaust Air/Motor Filter	Trimmed to Size
Number of Vacuum Cleaner Bags	4
Holding Plate Width x Height	92 x 84 mm

- Certified: filter performance, suction power and operating life tested by TÜV (German technical inspection association)
- MicroMultiFleece with a filtration of 99.9%, prevents germ formation and mould growth; the multi-layer structure effectively traps fine dust and allergens like pollen and mites
- With dust seal
- Highly loadable plastic connection
- Replacement bag for Miele vacuum cleaner bags with the designation: G/H/N (bottom side = 4 rollers)
- Replacement bag for Miele vacuum cleaner series with the designation: Cat & Dog 5000, Haus & Co 5000, Medicair 5000, Parket & Co 5000, Premium 5000, Tango und Tango Plus



MI 03 Vacuum Cleaner Bags

Exhaust Air/Motor Filter	Trimmed to Size
Number of Vacuum Cleaner Bags	4
Holding Plate Width x Height	79 x 93 mm

- Certified: filter performance, suction power and operating life tested by TÜV (German technical inspection association)
- MicroMultiFleece with a filtration of 99.9%, prevents germ formation and mould growth; the multi-layer structure effectively traps fine dust and allergens like pollen and mites
- Suitable for Miele vacuum cleaner bags with the designation: Size: type K



MI 04 P Vacuum Cleaner Bags

Exhaust Air/Motor Filter	Trimmed to Size
Number of Vacuum Cleaner Bags	5
Holding Plate Width x Height	95 x 94 mm

- Made of special paper
- Paper especially suited to the vacuum cleaner
- Suitable for Miele vacuum cleaner bags with the designation: Size: type B



Accessories for household appliances

...	Stove & glass ceramic hob	Extractor hood	Microwave	Vacuum cleaner	
-----	---------------------------	----------------	-----------	----------------	--



MO 01 Vacuum Cleaner Bags

Exhaust Air/Motor Filter	Trimmed to Size
Number of Vacuum Cleaner Bags	5
Holding Plate Width x Height	95 x 92 mm

- MicroMultiFleece with a filtration of 99.9%, prevents germ formation and mould growth; the multi-layer structure effectively traps fine dust and allergens like pollen and mites
- Suitable for Moulinex vacuum cleaner bags with the designation: Size: 250; A 82
- Also suitable for different vacuum cleaner bags from: Krups; Lloyds; Privileg; Satrap



NI 01 Vacuum Cleaner Bags

Exhaust Air/Motor Filter	Not needed
Number of Vacuum Cleaner Bags	3
Holding Plate Width x Height	126 x 95 mm

- MicroMultiFleece with a filtration of 99.9%, prevents germ formation and mould growth; the multi-layer structure effectively traps fine dust and allergens like pollen and mites
- Suitable for: Nilfisk vacuum cleaner bags with the designation: 816 200
- Nilfisk devices with the designation: G 90; GA 70; GM 80; GM 90; GS 80; GS 84; GS 90; ES N



NI 02 Vacuum Cleaner Bags

Exhaust Air/Motor Filter	Not needed
Number of Vacuum Cleaner Bags	4
Holding Plate Width x Height	97 x 82 mm

- Certified: filter performance, suction power and operating life tested by TÜV (German technical inspection association)
- MicroMultiFleece with a filtration of 99.9%, prevents germ formation and mould growth; the multi-layer structure effectively traps fine dust and allergens like pollen and mites
- Suitable for: Nilfisk vacuum cleaner bags with the designation: 818 460 00; 223 595 00
- Nilfisk devices with the designation: Arnoldi; Extreme X 110 > 300; GM 200 > 499; GM 500 > 599; GMD 400 > 430; Home; Hygienic; King 510; King 520; King 530; King 540; King Great Dane; King Special; Mocca; Seasons; Siena; Special; DS ZS N
- Team devices with the designation: ST 16



Accessories for household appliances

...

Stove & glass ceramic hob

Extractor hood

Microwave

Vacuum cleaner



OM 03 P Vacuum Cleaner Bags

Exhaust Air/Motor Filter	Trimmed to Size
Number of Vacuum Cleaner Bags	9
Holding Plate Width x Height	105 x 85 mm

- Solid paper form, especially suited to the vacuum cleaner
- Suitable for Omega vacuum cleaner bags with the designation: Size: 15585.340.014.0
- Also suitable for different vacuum cleaner bags from: Bauer-Versand; Bomann; Collo; Elite; Favorit; Viking



OM 06 Vacuum Cleaner Bags

Exhaust Air/Motor Filter	Trimmed to Size
Number of Vacuum Cleaner Bags	4
Holding Plate Width x Height	90 x 90 mm

- Certified: filter performance, suction power and operating life tested by TÜV (German technical inspection association)
- MicroMultiFleece with a filtration of 99.9%, prevents germ formation and mould growth; the multi-layer structure effectively traps fine dust and allergens like pollen and mites
- With dust seal
- Suitable for Omega vacuum cleaner bags with the designation: Size: E 100
- Suitable for Hoover vacuum cleaner bags with the designation: Size: H 58
- Also suitable for different vacuum cleaner bags from: Eumig, Fakir; LIV; Lloyds; Privileg; Rotel; Severin



PA 02 Vacuum Cleaner Bags

Exhaust Air/Motor Filter	Trimmed to Size
Number of Vacuum Cleaner Bags	5
Holding Plate Width x Height	112 x 98 mm

- MicroMultiFleece with a filtration of 99.9%, prevents germ formation and mould growth; the multi-layer structure effectively traps fine dust and allergens like pollen and mites
- With dust seal
- Suitable for Panasonic vacuum cleaner bags with the designation: Size: C-15-C; AMC 8 F88 L 1000



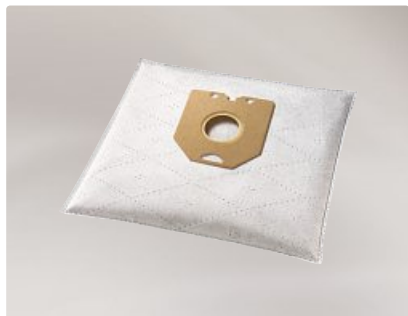

PH 01 Vacuum Cleaner Bags

Exhaust Air/Motor Filter	Trimmed to Size
Number of Vacuum Cleaner Bags	4
Holding Plate Width x Height	106 x 110 mm

- Certified: filter performance, suction power and operating life tested by TÜV (German technical inspection association)
- MicroMultiFleece with a filtration of 99.9%, prevents germ formation and mould growth; the multi-layer structure effectively traps fine dust and allergens like pollen and mites
- Suitable for Philips vacuum cleaner bags with the designation: Size: Oslo; HR 6938; HR 6939, HR 6983
- Also suitable for different vacuum cleaner bags from: Karstadt; Lloyds; Mio-Star; Ruten; Bomann; Clatronic; Dirt Devil; Nilfisk



PR 03 P Vacuum Cleaner Bags

Exhaust Air/Motor Filter	Trimmed to Size
Number of Vacuum Cleaner Bags	5
Holding Plate Width x Height	105 x 105 mm

- Made of special paper
- With dust seal
- Solid paper form, especially suited to the vacuum cleaner
- Suitable for Progress vacuum cleaner bags with the designation: Size: P 45
- Suitable for Electrolux vacuum cleaner bags with the designation: Size: E 10
- Suitable for Volta vacuum cleaner bags with the designation: Size: V 3
- Also suitable for different vacuum cleaner bags from: Tornado; Zanussi



RO 01 Vacuum Cleaner Bags

Exhaust Air/Motor Filter	Trimmed to Size
Number of Vacuum Cleaner Bags	4
Holding Plate Width x Height	130 x 100 mm

- Certified: filter performance, suction power and operating life tested by TÜV (German technical inspection association)
- MicroMultiFleece with a filtration of 99.9%, prevents germ formation and mould growth; the multi-layer structure effectively traps fine dust and allergens like pollen and mites
- With dust seal
- Suitable for Rowenta vacuum cleaner bags with the designation: Size: ZR-76/ ZR 7601; ZR 765
- Suitable for Fakir vacuum cleaner bags with the designation: Size S 200
- Suitable for Chromex vacuum cleaner bags with the designation: Size CH 248
- Suitable for Dicaff vacuum cleaner bags with the designation: Size T 15
- Also suitable for different vacuum cleaner bags of: AFK; Beam; Bliss; Calor; Darel; De"Longhi; De Sina; Elin; EUP; Famulus; Hanseatic; Kenwood; König; Lloyds; Omega; SHL; Sidem/Sidex; Tefal, Tip Top, Siemens; Alaska; Bauknecht; Diamant; Ecktia; Fakir; FAM; Hollandia; Principal; White&Brown; Wilfa



Accessories for household appliances

...

Stove & glass ceramic hob

Extractor hood

Microwave

Vacuum cleaner



RO 04 Vacuum Cleaner Bags

Exhaust Air/Motor Filter	Trimmed to Size
Number of Vacuum Cleaner Bags	5
Holding Plate Width x Height	108 x 90 mm

- MicroMultiFleece with a filtration of 99.9%, prevents germ formation and mould growth; the multi-layer structure effectively traps fine dust and allergens like pollen and mites
- Suitable for Rowenta vacuum cleaner bags with the designation: Size: ZR-455
- Also suitable for different vacuum cleaner bags from: Moulinex; Artec



RO 06 Vacuum Cleaner Bags

Exhaust Air/Motor Filter	Original Size
Number of Vacuum Cleaner Bags	5
Holding Plate Width x Height	145 x 92 mm

- MicroMultiFleece with a filtration of 99.9%, prevents germ formation and mould growth; the multi-layer structure effectively traps fine dust and allergens like pollen and mites
- Suitable for Rowenta vacuum cleaners: RO1600 à 1699 Spacéo; RO4100 à 4199 Artec 2; RO 4200 à 4299 X-Treme; RO 4300 à 4399 SF Compact; Silence Force
- Suitable for Moulinex vacuum cleaners; série Manea; CER 141; CER 361; ZR-0015



SOS 01 Vacuum Cleaner Bag

Exhaust Air/Motor Filter	Trimmed to Size
Number of Vacuum Cleaner Bags	5
Holding Plate Width x Height	110 x 90 mm

- MicroMultiFleece with a filtration of 99.9%, prevents germ formation and mould growth; the multi-layer structure effectively traps fine dust and allergens like pollen and mites
- Universal bags - suitable for nearly all vacuum cleaners
- The original flange is removed from the old vacuum cleaner bag and has to be fixed on the adhesive surface of the universal bag



Accessories for household appliances

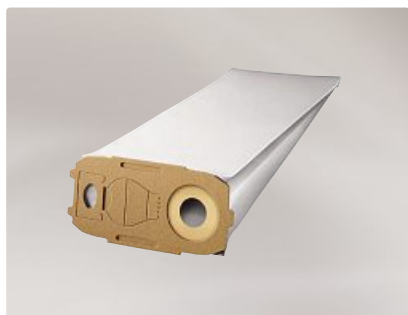

VO 01 P Vacuum Cleaner Bags

Exhaust Air/Motor Filter	Not needed
Number of Vacuum Cleaner Bags	5
Holding Plate Width x Height	162 x 77 mm

- Made of special paper
- With dust seal
- With handle for easy removal
- Solid paper form, especially suited to the vacuum cleaner
- Suitable for Vorwerk vacuum cleaner bags with the designation: Size: VK 118-122



VO 02 P Vacuum Cleaner Bags

Exhaust Air/Motor Filter	Trimmed to Size
Number of Vacuum Cleaner Bags	5
Holding Plate Width x Height	223 x 151 mm

- Made of special paper
- With dust seal
- With handle for easy removal
- Solid paper form, especially suited to the vacuum cleaner
- Suitable for Vorwerk vacuum cleaner bags with the designation: Size: VK 250-252



VO 03 Vacuum Cleaner Bags

Exhaust Air/Motor Filter	Not needed
Number of Vacuum Cleaner Bags	5
Holding Plate Width x Height	208 x 82 mm

- Made of special paper
- With dust seal
- With handle for easy removal
- Solid paper form, especially suited to the vacuum cleaner
- Suitable for Vorwerk vacuum cleaner bags with the designation: Size: VK 130-131



Accessories for household appliances

...

Stove & glass ceramic hob

Extractor hood

Microwave

Vacuum cleaner

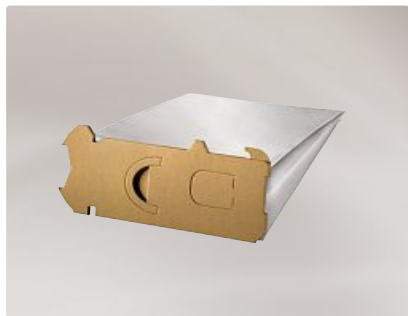

VO 04 P Vacuum Cleaner Bags

Exhaust Air/Motor Filter	Not needed
Number of Vacuum Cleaner Bags	4
Holding Plate Width x Height	207 x 80 mm

- Made of special paper
- With dust seal
- With handle for easy removal
- Solid paper form, especially suited to the vacuum cleaner
- Suitable for Vorwerk vacuum cleaner bags with the designation: Size: VK 135

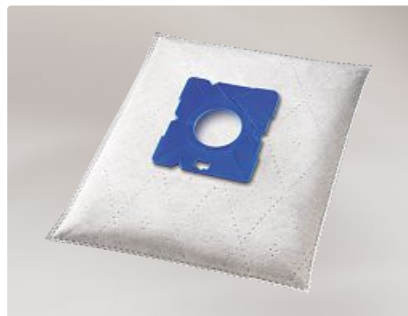

XA 01 Vacuum Cleaner Bags

Exhaust Air/Motor Filter	Trimmed to Size
Number of Vacuum Cleaner Bags	4
Holding Plate Width x Height	110 x 99 mm

- Certified: filter performance, suction power and operating life tested by TÜV (German technical inspection association)
- MicroMultiFleece with a filtration of 99.9%, prevents germ formation and mould growth; the multi-layer structure effectively traps fine dust and allergens like pollen and mites
- With dust seal
- Highly loadable plastic connection
- Standard size for all vacuum cleaners with 98x110mm mounting flange
- Replacement for the following original vacuum cleaner bags:
 - Bomann CB 949, 966, 969, 991
 - CTC/Clatronic size: 101, 201; BS 1232/33
 - Daewoo size: SB 100
 - Electrolux E 62, 66, ES 66
 - Fakir/Nilco: 20 06 805, 24 12 805, 24 22 805, 27 22 805
 - Hoover: DW 1, GL 3, H 66
 - Kärcher size: 6.969-001
 - Philips size: Geneva, HR 6995
 - Progress size: P 55, 59, 120, PD 1, PT 3
 - Samsung size: VP 50, 77, 78, VT 89
 - Severin size: SB 9017, 9026, 9517



XA 02 Vacuum Cleaner Bags

Exhaust Air/Motor Filter	Trimmed to Size
Number of Vacuum Cleaner Bags	4
Holding Plate Width x Height	82 x 84 mm

- Certified: filter performance, suction power and operating life tested by TÜV (German technical inspection association)
- MicroMultiFleece with a filtration of 99.9%, prevents germ formation and mould growth; the multi-layer structure effectively traps fine dust and allergens like pollen and mites
- With dust seal
- Suitable for Bomann vacuum cleaner bags with the designation: Size: B 52
- Suitable for Clatronics: Size: SSB 98
- Suitable for Hoover: Size: H 55
- Suitable for Progress: Size: P 56; P 67/S
- Suitable for Severin: Size: SB 9022
- Suitable for Taurus: Size: 948.603; 948.623
- Suitable for Schott: Size: ST 31 EC
- Suitable for Chromex : Size: CH 960; CH 283; CH 284; CH 285
- Suitable for De Sina: Size: 1090641
- Suitable for Silva: Size: TB 13
- Also suitable for different vacuum cleaner bags from: AFK, Alaska; Arc En Ciel; Bestron; Blue Air; Boosty; Condel; Dilem; Dirt Devil; DomoStar; Ecron; E-Matic; e-matic; Efbe (Schott); Elvita; El Star; EUP; Eurelem; Express; Fagor; Ferm; Ferrari; FIF; Flama; Fuda; Gemex; Germatic; Hit Company; HUP; IDE Line; Imetec; ITO; Kaisui; Kalorik; Laser; Lervia; Letron; Lloyds; Maxum; MPM; M-Tec; Nevir; OBH; Primera; Privileg; Protech; Quigg; Rotel; Salco; Selecline; Siplec; Skyline; SMC; Solac; Standard; Tchibo (TCM); TEAM; Tokiwa; Tornado; Trilec; Triumph; Trisa; Tristar; UFESA; United; Z.W.T; Weltstar; Westfalia; White& Brown; Zimatik



110028

4 047443 000323



110007

4 047443 000118



110018

4 047443 000224

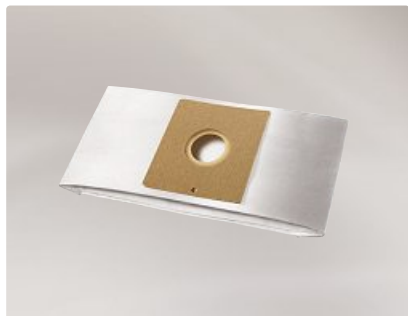

XA 03 P Vacuum Cleaner Bags

Exhaust Air/Motor Filter	Trimmed to Size
Number of Vacuum Cleaner Bags	5
Holding Plate Width x Height	110 x 100 mm

- Made of special paper
- Solid paper form, especially suited to the vacuum cleaner
- Suitable for Fakir vacuum cleaner bags with the designation: Size: 2006805; A 90
- Also suitable for different vacuum cleaner bags from: Buesky; Darel; LG Electronics; Medion; Samsung; SERD; Solac; Tristar

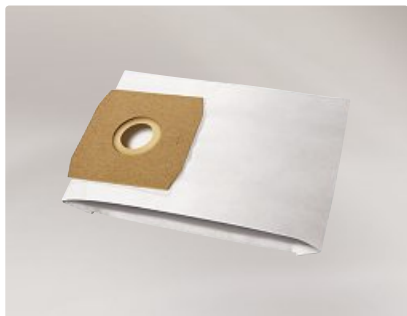

XA 04 P Vacuum Cleaner Bags

Exhaust Air/Motor Filter	Not needed
Number of Vacuum Cleaner Bags	5
Holding Plate Width x Height	110 x 105 mm

- Made of special paper
- Solid paper form, especially suited to the vacuum cleaner
- Suitable for Daewoo vacuum cleaner bags with the designation: Size: RC 300; 320; 350; 370; 805 D; 805 H
- Also suitable for different vacuum cleaner bags from: AFK; Alaska

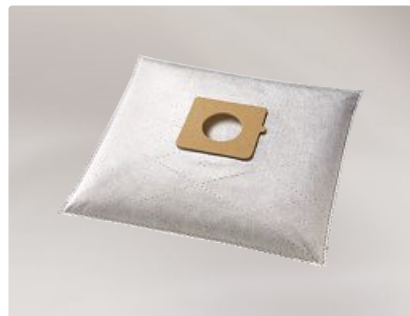

XA 05 Vacuum Cleaner Bags

Exhaust Air/Motor Filter	Original Size
Number of Vacuum Cleaner Bags	4
Holding Plate Width x Height	97 x 86 mm

- Certified: filter performance, suction power and operating life tested by TÜV (German technical inspection association)
- MicroMultiFleece with a filtration of 99.9%, prevents germ formation and mould growth; the multi-layer structure effectively traps fine dust and allergens like pollen and mites
- Suitable for Clatronic vacuum cleaner bags with the designation: Size: SSB 30
- Suitable for Silva vacuum cleaner bags with the designation: Size: TB 16
- Also suitable for different vacuum cleaner bags from: Bomann; LG Electronics; Holland Electro; Privileg; Satrap; Solac; Gold Star



Accessories for household appliances

...	Stove & glass ceramic hob	Extractor hood	Microwave	Vacuum cleaner
-----	---------------------------	----------------	-----------	-----------------------



XA 06 Vacuum Cleaner Bags

Exhaust Air/Motor Filter	Trimmed to Size
Number of Vacuum Cleaner Bags	5
Holding Plate Width x Height	112 x 93 mm

- MicroMultiFleece with a filtration of 99.9%, prevents germ formation and mould growth; the multi-layer structure effectively traps fine dust and allergens like pollen and mites
- Suitable for Bomann vacuum cleaner bags with the designation: Size: CB 929; CB 917
- Suitable for Trisa vacuum cleaner bags with the designation: Size: Beetle
- Suitable for Solac vacuum cleaner bags with the designation: Size: 901; 903
- Also suitable for different vacuum cleaner bags from: Alaska; AFK; CTC Clatronic; De Sina; Dun Rite; Durabrand; Holland Electro; Home Electronics; Ide Line; Kinglake; MBO; Mia; Mistral; Primera; Prophete; Saturn; Team; Tip Top; Tristar; Weltstar; Bauer Versand; SMC; Dirt Devil; Wilfa

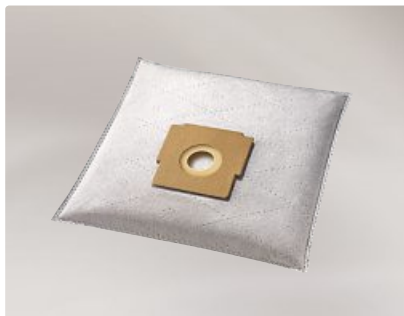

ZE 01 Vacuum Cleaner Bags

Exhaust Air/Motor Filter	Trimmed to Size
Number of Vacuum Cleaner Bags	4
Holding Plate Width x Height	100 x 98 mm

- Certified: filter performance, suction power and operating life tested by TÜV (German technical inspection association)
- MicroMultiFleece with a filtration of 99.9%, prevents germ formation and mould growth; the multi-layer structure effectively traps fine dust and allergens like pollen and mites
- Suitable for Zelmer vacuum cleaner bags with the designation: Size: 49.4000
- Also suitable for different vacuum cleaner bags from: Bestron; Fakir, Hanseatic; Lloyds; Viking; Wilfa; Dalco



ZE 02 Vacuum Cleaner Bags

Exhaust Air/Motor Filter	Trimmed to Size
Number of Vacuum Cleaner Bags	5
Holding Plate Width x Height	90 x 90 mm

- MicroMultiFleece with a filtration of 99.9%, prevents germ formation and mould growth; the multi-layer structure effectively traps fine dust and allergens like pollen and mites
- Suitable for different vacuum cleaner bags from: Zelmer; Alaska; Bestron; Clatronic CTC; Curtiss; De Sina; Hanseatic; InterClean; Kenwood; Lloyds; Privileg; Rotel; Solac



Accessories for household appliances

...	Stove & glass ceramic hob	Extractor hood	Microwave	Vacuum cleaner	
-----	---------------------------	----------------	-----------	----------------	--



ZE 04 Vacuum Cleaner Bags

Exhaust Air/Motor Filter	Trimmed to Size
Number of Vacuum Cleaner Bags	4
Holding Plate Width x Height	108 x 100 mm

- Certified: filter performance, suction power and operating life tested by TÜV (German technical inspection association)
- MicroMultiFleece with a filtration of 99.9%, prevents germ formation and mould growth; the multi-layer structure effectively traps fine dust and allergens like pollen and mites
- Suitable for Zelmer vacuum cleaner bags with the designation: Size: 49.4100
- Also suitable for different vacuum cleaner bags from: Fakir, Hanseatic



OM 02 P Vacuum Cleaner Bags

Exhaust Air/Motor Filter	Trimmed to Size
Number of Vacuum Cleaner Bags	5
Holding Plate Width x Height	95 x 93 mm

- Made of special paper
- Suitable for Omega vacuum cleaner bags with the designation: Size: Carat; Effect; Power; Power 2000
- Suitable for Progress vacuum cleaner bags with the designation: Size: PL 5
- Suitable for Eta vacuum cleaner bags with the designation: Size: 406; 407; 408; Quinto; Birdy
- Also suitable for different vacuum cleaner bags from: Bauknecht; Bob Home; Bomann; De' Longhi; DIV; Elin; Fakir; FAM; Famulus; Holland Electro; Horizon; Lloyds; Mastercraft; Neufunk; Thomas; Ufesa; Wigo

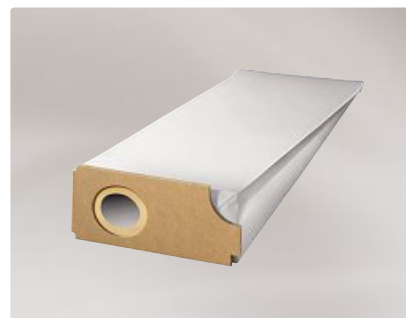

KÄ 01 P Vacuum Cleaner Bags

Exhaust Air/Motor Filter	Not needed
Number of Vacuum Cleaner Bags	5
Holding Plate Width x Height	148 x 73 mm

- Made of special paper
- Suitable for: Kärcher vacuum cleaner bags with the designation: 6.904-059; 6.904-311; 6.906-097
- Kärcher devices with designation: 1033-101; 1033-301; 1057-101; 1057-301; CV 36/2; CV 46/2; CW 50; CW 100; TBS 35; oEZ K
- Columbus devices with the designation: BS 360; BS 460; TK; 25; TK 36; TK 46
- Sebo devices with the designation: 36; 46; 360; 460



- Vacuum Cleaner Bag
- Vacuum cleaner extracted air cleaner**
- Vacuum cleaner engine filter
- HEPA Filter
- Vacuum Cleaner Nozzle
- Vacuum Cleaner Replacement Part



AF 01 Exhaust Air Filter

- Universal special filter for exhaust air



- Vacuum Cleaner Bag
- Vacuum cleaner extracted air cleaner
- Vacuum cleaner engine filter**
- HEPA Filter
- Vacuum Cleaner Nozzle
- Vacuum Cleaner Replacement Part



MF 01 Motor Filter

Width x Length	12 x 17 cm
----------------	------------

- By cutting, the filter can very easily be adapted to nearly all vacuum cleaners

		110241	
20	PO		

Lighting

Coffee & Tea

Household goods & Decoration

Small household appliances

Cleaning & Care

Energy & Technology

Accessories for household appliances

- Vacuum Cleaner Bag
- Vacuum cleaner extracted air cleaner
- Vacuum cleaner engine filter
- HEPA Filter**
- Vacuum Cleaner Nozzle
- Vacuum Cleaner Replacement Part



"FF 06" Fine Filter for AEG

- To maintain effective filtration, the filter must be replaced at least once a year
- Suitable for AEG devices with the designation:
- System Pro: P1, P3, P5,
- Viva Control: AVC 1110... 1120,1130,1190
- Viva Quickstop: AVQ 2115 - 2120, AVQ 2126
- Suitable for Electrolux devices with the designation:
- Airmax: AAM 6100...6108
- Clario: AEC 7570, 7571, 7572
- Cyclone XL: ACX 6200...6203
- System Pro: P3, P3 Plus, P3 Flexi
- Viva Control: AVC 1110... 1120,1130,1190
- Viva Quickstop: AVQ 2115 - 2120, AVQ 2126
- Suitable for Volta devices with the designation:
- Bolido U 4500-4595, Control U 4410-4440,
- Gemini U 2810-2890/2910-2990
- Suitable for Tornado devices with the designation:
- Bolido: U 4510-4595, Essensio TO 4610/N
- Suitable for Progress devices with the designation: Magnum
- Suitable for Hugin devices with the designation: Phantom
- Suitable for Philips devices with the designation: Specialist, Universe

		110297
24	PO	
215 x 350		
4		047443 048189



HF 02 Hepa Filter for AEG

- Cartridge with hypo-allergenic filter of Hepa H 12 filter class
- To maintain effective filtration, the Hepa filter must be replaced at least once a year
- Suitable for AEG devices with the designation: System Pro: P1 > P 999 , Oxygen+, Oxy3System, System_Pro, Ultra Silencer, Maximus, Viva Control, Viva Quickstop, Twin Clean, Cyclone XL, Air Max
- Manufacturer designation: 900 195 150/9, 900 196 669, 900 195 150
- Suitable for Elektrolux devices with the designation: Clario: Z1915, 1925, 1935, 1943, 1944, 1948, 1955; Cyclone Power; Excellio; Oxygen; Praxio; Power System; Smartvac: Z5000 > 5695; Ultra Silencer: Z3341
- Manufacturer designation: 117 975 557
- Suitable for Hugin devices with the designation: Phantom
- Suitable for Philips devices with the designation: Specialist; Universe; Jewel
- Philips filter designation: FC 8030/00
- Suitable for Progress devices with the designation: Magnum
- Suitable for Tornado devices with the designation: Bolido; Serenys; Magnum; 6000
- Suitable for Volta devices with the designation: Gemini; Bolido; Trio Compact: U 6025

		110293
22	PO	
215 x 350		
4		047443 003836



HF 03 Hepa Filter for Bosch/Siemens

- Cartridge with hypo-allergenic filter of Hepa H 12 filter class
- To maintain effective filtration, the Hepa filter must be replaced at least once a year
- Suitable for Bosch devices with the designation: BSG 8 etc.
- Manufacturer designation: BBZ 151 HF
- Suitable for Siemens devices with the designation: VS 08...
- Manufacturer designation: VZ 151 HFB



HF 05 Hepa Filter for Bosch/Siemens

- Cartridge with one hypo-allergenic filter, filter class: Hepa H 12
- To maintain effective filtration, the Hepa filter must be replaced at least once a year
- Suitable for Bosch/Siemens devices with the designation: Activa 61 = BBS 6100; Casa 12 = BSC 1200; Compact Plus; Dino; Edition 150; Exclusiv; Green Energy; Idea 12; Natura; Power Edition; Evolution; Plus; Pro Hygienic; Silence 1400W; Ultra 10, 11, 12; Spera 22, 24; Solitarie
- Suitable for Bosch devices with the designation: BSA...; BBS 6...; BBS 7...; BBS 8...; BSC...; BSD...; BSG 4...; BSF...; BSG L2
- Suitable for Siemens devices with the designation: VS 04G...; VS 50A.../50B.../50C.../50D.../50E.../50KA...; VS 60A...; VS 70C.../D...; VS 9A...; VS 32.../33...; VS 42.../44...
- Manufacturer designation: Bosch BBZ 8 SF 1 and Siemens VZ 54000



"HF 01" Hepa Filter for Miele

- Cartridge with hypo-allergenic filter of Hepa H 12 filter class
- To maintain effective filtration, the Hepa filter must be replaced at least once a year
- Suitable for Miele devices with the designation: S2, S300-800, S7 and Complete C1, Classic C1, Dynamic U1
- Manufacturer designation: SF-AH 30; SF-HA 30; Nr. 9.616.270

20		PO	110294	
215 x 350		4	047443 003843	

20		PO	110296	
215 x 350		4	047443 003867	

22		PO	110292	
215 x 350		4	047443 003829	



HF 04 Hepa Filter for Miele

- Cartridge with one hypo-allergenic filter: filter class Hepa H 12
- To maintain effective filtration, the Hepa filter must be replaced at least once a year
- Suitable for Miele devices with the designation: S4, S5, S6, S8 and Compact C1-C2, Complete C2-C3
- Manufacturer designation: SF-AH 50, SF-HA 50; Nr. 9.616.280

Vacuum Cleaner Bag

Vacuum cleaner extracted air cleaner

Vacuum cleaner engine filter

HEPA Filter

Vacuum Cleaner Nozzle

Vacuum Cleaner Replacement Part



Turbo Brush "TB-140" with Universal Connection, large

Tube Connection	Universal (31 - 37 mm)
-----------------	------------------------

- With rotating brush roller, ideal e.g. for animal hair, threads and similar dirt
- Removes engrained dirt and worn patches and lifts up carpeted floors
- Also suitable for smooth floors
- The brush is powered by the air flow (no additional power supply connection required)
- With cleaning flap; allows the turbine to be easily cleaned
- The 4 rubberized rollers make it especially easy to steer and floor-friendly
- Fits practically all vacuum cleaners





Turbo Brush, small, universal connection

Tube Connection	Universal (31 - 37 mm)
-----------------	------------------------

- Universal brush for intensive cleaning of small surfaces, such as e.g. upholstery and motorcar carpets, etc...
- With rotary brush-rolls ideally for e.g. animal hair, fabric fiber and similar dirt
- Removes low-sitting dirt
- By compact design even for smaller and impenetrable surfaces
- Brush is propelled by the air flow (needs no additional power connection)
- Suitable for nearly all vacuum cleaners
- Tube connection: universal/continuous (for 31 - 37 mm tubes)



Turbo Brush, small, 32/35mm

Tube Connection	32 mm/35 mm
-----------------	-------------

- With rotary brush-rolls ideally for e.g. animal hair, fabric fiber and similar dirt
- Removes low-sitting dirt
- By compact design even for smaller and impenetrable surfaces
- Brush is propelled by the air flow (needs no additional power connection)
- Suitable for nearly all vacuum cleaners
- Tube connection: 35 mm (by enclosed adaptor also suitable for 32 mm)



Universal Nozzle BD-100

Tube Connection	32 mm/35 mm
-----------------	-------------

- By the double thread catcher, hairs and fabric fiber are very effectively removed
- Good cleaning over the whole nozzle-broad
- By current brush border good cleaning results on all smooth soils
- Very long-lived by the base plate made of high-grade steel
- Particularly manoeuvrable by the combined swivel and tilting joint
- Comfortable switching by foot between carpet and smooth soils
- Suitable for nearly all vacuum cleaners
- Tube connection: 35 mm (by enclosed adaptor also suitable for 32 mm)





Universal Nozzle BD-100

For gently cleaning carpets and smooth flooring

Item No. 110260



Universal Nozzle BD-150

Tube Connection	32 mm/35 mm
-----------------	-------------

- Especially flat version, therefore ideal under low sofas and cupboards
- Good cleaning over the whole nozzle-broad
- By the double thread catcher, hairs and fabric fiber are very effectively removed
- Comfortable switching by foot between carpet and smooth soils
- Very long-lived by the base plate made of high-grade steel
- Particularly manoeuvrable by the combined swivel and tilting joint
- Comfortable switching by foot between carpet and smooth soils
- Suitable for nearly all vacuum cleaners
- Tube connection: 35 mm (by enclosed adaptor also suitable for 32 mm)

12 CB		110261	
4 047443 002037			



Parquet Nozzle HD-100 with Horse Hair

Tube Connection	32 mm/35 mm
-----------------	-------------

- Both rubberized rollers are very low-friction and prevent a fast wear out of the nature fibres
- Especially flat version, therefore ideal under low sofas and cupboards
- Very good cleaning over the whole nozzle-broad
- Nozzle with hinge joint
- Suitable for nearly all vacuum cleaners
- Tube connection: 35 mm (by enclosed adaptor also suitable for 32 mm)

6 BC		110262	
210 x 355		4 047443 002044	



Parquet Nozzle HD-150 with synthetic fiber

Tube Connection	32 mm/35 mm
-----------------	-------------

- Both rubberized rollers are very low-friction and prevent a fast wear out of the nature fibres
- Especially flat version, therefore ideal under low sofas and cupboards
- Very good cleaning over the whole nozzle-broad
- Nozzle with hinge joint
- Suitable for nearly all vacuum cleaners
- Tube connection: 35 mm (by enclosed adaptor also suitable for 32 mm)
- 1 piece packed in blister

6 BC		110263	
215 x 358		4 047443 002051	

Accessories for household appliances

...	Stove & glass ceramic hob	Extractor hood	Microwave	Vacuum cleaner
-----	---------------------------	----------------	-----------	----------------



"PD-200" Upholstery Nozzle

Tube Connection	Universal (28 - 37 mm)
-----------------	------------------------

- Suitable for nearly all vacuum cleaners
- Its compact design allows you to use it on small surfaces
- Double thread catcher for easily removing hair and fibres
- Best suited e.g. for automotive seats, curtains and upholstery
- 1 piece in blister packaging



"PD-150" Upholstery Nozzle

Tube Connection	32 mm/35 mm
-----------------	-------------

- Suitable for nearly all vacuum cleaners
- 35 mm tube connection, with the enclosed adapter also suitable for 32 mm tubes
- Its compact design allows you to use it on small surfaces
- Double thread catcher for easily removing hair and fibres from fabric
- Best suited e.g. for automotive seats and upholstery



Nozzle for Joints FD-100 with Dust Brush

Tube Connection	32 mm/35 mm
-----------------	-------------

- Slim design
- The plug-on dust brush removes dust and fluff ball also from small grooves and gaps (ideally in the car for air grille)
- Suitable for nearly all vacuum cleaners
- Tube connection: 35 mm (with enclosed adaptor also suitable for 32 mm)

		110248	
8	BC		
215 x 355		4 047443 047830	

		110266	
6	BC		
160 x 230		4 047443 002082	

		110264	
6	BC		
140 x 230		4 047443 002068	



Nozzle for Joints FD-150 Long

Tube Connection	32 mm/35 mm
-----------------	-------------

- Particularly long and slim design (for cars, upholstery etc.)
- Suitable for nearly all vacuum cleaners
- Tube connection: 35 mm (with enclosed adaptor also suitable for 32 mm)

8		BC	110265	
105 x 300		4		047443 002075



Round Nozzle SD-100, rotary

Tube Connection	32 mm/35 mm
-----------------	-------------

- Suitable for nearly all vacuum cleaners
- 35 mm connection, with the enclosed adaptor also suitable for 32 mm tubes
- The swivel joint allows the nozzle's opening to be rotated 360°, therefore also suitable for hard to reach places
- The brush annulus consists of soft synthetic fibres which also makes it suitable for sensitive surfaces
- Ideal e.g. for cars, furniture and shelves

6		BC	110268	
140 x 230		4		047443 002105



Furniture Nozzle SD-150

Tube Connection	32 mm/35 mm
-----------------	-------------

- Persistent dust is through the fibres removed (e.g. on uneven surfaces or furniture decorations)
- By the rectangular design also for larger surfaces
- For vacuum cleaner with 35 mm tube connection (incl. adaptor for 32 mm tube)

6		BC	110267	
140 x 230		4		047443 002099

- Vacuum Cleaner Bag
- Vacuum cleaner extracted air cleaner
- Vacuum cleaner engine filter
- HEPA Filter
- Vacuum Cleaner Nozzle
- Vacuum Cleaner Replacement Part**



Telescopic Vacuum Cleaner Tube TR-100, 35 mm, chromium-plated

Diameter Machine End	35 mm
Diameter Nozzles	35 mm

- Suitable for nearly all vacuum cleaners
- With 35 mm connection
- Very sturdy due to chrome-plated metal design
- Adjustable to the required length by simply pressing a button (extendible from 485 mm to 790 mm)

110269

6	BC	
920 x 590		

4 047443 002112



TR-101 Telescopic Vacuum Cleaner Tube, 32 mm, chrome-plated

Diameter Machine End	32 mm
Diameter Nozzles	32 mm

- Suitable for nearly all vacuum cleaners
- With 32 mm connection
- Very sturdy due to chrome-plated metal design
- Adjustable to the required length by simply pressing a button (extendible from 485 mm to 790 mm)

110270

6	BC	
920 x 588		

4 047443 002129



Vacuum Cleaner Insert Tube SR-101, 32 mm, plastic

Diameter Machine End	32 mm
Diameter Nozzles	32 mm

- Suitable for nearly all vacuum cleaners
- With 32mm connection
- Very lightweight but solid plastic tube
- By plugging together, adjustable length (by single pipe 440mm; plugged together 845mm)

Vacuum Cleaner Insert Tube SR-101, 35 mm, plastic

Diameter Machine End	35 mm
Diameter Nozzles	35 mm

- With 35mm connection
- Very lightweight but solid plastic tube
- By plugging together, adjustable length (by single pipe 440mm; plugged together 845mm)

Adapter SD-500

Diameter Machine End	35 mm
Diameter Nozzles	35 mm

- Universal adapter for all nozzles and brushes with 35mm tube connection



Accessories for household appliances

...	Stove & glass ceramic hob	Extractor hood	Microwave	Vacuum cleaner
-----	---------------------------	----------------	-----------	----------------



Adapter SD-501

Diameter Machine End	no specifications
Diameter Nozzles	32 mm

- Universal adapter for all nozzles and brushes with 35mm tube connection



Universal Handle, 32 mm

Diameter Machine End	no specifications
Diameter Nozzles	32 mm

- Ergonomically shaped
- With click ring connection for the vacuum cleaner hose
- Cone connection 1:30 for 32 mm vacuum cleaner tubes
- Integrated admixed air regulator
- Suitable for a lot of models from AEG, Elektrolux, Kärcher, Nilfisk, Numatik
- Material: PP



Universal Handle, 35 mm

Diameter Machine End	no specifications
Diameter Nozzles	35 mm

- Ergonomically shaped
- With click ring connection for the vacuum cleaner hose
- Cone connection 1:50 for 35 mm vacuum cleaner tubes
- Integrated admixed air regulator
- Suitable for a lot of models from Bosch, Miele, Panasonic, Rowenta, Samsung, Siemens
- Material: PP





Vacuum Hose for Vacuum Cleaners "SC 100", pre-assembled

Diameter Machine End	45 mm
Diameter Nozzles	45 mm

- Due to the specific weight (0.94 according to Din 53 479) also suitable to exhaust swimming pools
- Completely pre-assembled with click rings and collets
- Glued collets (not releaseable)
- Diameter: inside 32 mm; outside 40.4 mm
- Temperature resistance: -25°C/+65°C
- Vacuum resistance: up to approx. 5m WS
- Antistatic according to Din 53 482

110273

6	CB
---	----

A

Alarm Doorstop	243
Angle valve	258
Anti-Slip Mat	279

B

Backing/Roast Thermometer	317
Baking set	152
Baking tin	151
Baking Tray	308
Bathroom scales	184
Body fat weighing scales	190
Bread knife	155

C

Capsule holder/stand	120
Chopping Board	312
Cleaning cloth	200, 307
Cleaning Kit	138
Cleaning set	203, 209
Coffee pad container	114
Coffee/tea container	119
Coffee & tea makers	131
Condenser Box	284
Cup set	113
Cutting board	153

D

Decorating stencils	132
Descaler	210
Dishwasher salt	199
Drain hose	265
Drinking glass	111
Dryer Ball	283

E

Electronic milk frother	134
Emergency Alarm	239
Exhaust Air Hose	285
Exhaust air pipe	321

F

Fluorescent lamp starter	98
Fluorescent lamp (T5)	96
Fluorescent lamp (T8 Daylight)	93
Fluorescent lamp (T8 Quality Plus)	92
Fluorescent lamp (T8 Standard)	95
Fluorescent tubes	68

G

G 4 lamps	87
G 9 lamps	82
Glass Breakage Detector	236
GU 4 lamps	89
GU 5,3 lamps	90
GU 10 lamps	83
GY 6,35 lamps	88

H

Halogen lamps 230V	75
Halogen lamps 12V	87
HEPA Filter	358
Home Appliance Vibration Damper	281
Hose break protection	263
Hose clip	264
Hose connector	261, 266, 301
Hose extension	260
Household Appliance Base	274
Household appliance connecting cable	270
Household Appliance Stacking Kit	275
Household cleaner	196, 198, 202, 213
Household filter	297, 323

I

Induction Hob Adapter	316
Insulated Bottle	110
Insulated Flask	108
Insulated Mug	104
Ironing board cover	292
Iron protector plate	291

K

Kitchen scales	178
Kitchen timer	181
Knife set	156

L

Lashing Strap	280
Laundry Net	288
LED campaign	69
LED-lamps (Classic Line)	57
LED-lamps (High Line)	44
Lid	161
Lighting Overview Matrix	32
Low-voltage transformers	73
Lubricant	139, 320

M

Measuring jug scales	180
Mechanical milk frother	135
Microwave Box Set	333
Microwave Bracket	327
Microwave Cover	328
Microwave Plate Set	330
Microwave-Safe Dishes	332
Milk jug	136
Milk supply hose	137
Motion alarm sensor	234
Multi-functional lighter	171

O

Oven glove	158
Overview Matrix Lighting	33
Overview Matrix Vacuum Cleaner Bags	334

P

Permanent Filter	129
Personal Alarm	241
Plastic wrap kit	149
Pot coaster set	159
Power cable	273
Power extension cable	272
Protective ironing cloth	290

R

R 7S lamps	85
Radiator Bleeder	250
Radio Socket	246
Reducer	322
Reflector lamps	80
Regulator for Radiators	247
Replacemant Blade	205, 306

Replacement pad for ironing board	293
Roasting/Baking Dish	309
Roller cover for ironing machines	294

S

Salad spinner	154
Scraper	204, 305
Siphon connection	268
Special lamp	298, 303, 325
Storage container set	148
Storage jar	146
Stove wiring box	271
Supply hose	259
Supply hose seal	262
Surveillance Camera Dummy	240

T

Thermometer	295
Thermostat Valve Adapter	249
Transport Device	278
Tubes	68

V

Vacuum Cleaner Bag	338
Vaccum Cleaner Bags Overview Matrix	334
Vacuum Cleaner engine filter	357
Vacuum Cleaner extracted air cleaner	356
Vacuum Cleaner Nozzle	360
Vacuum Cleaner Replacement Part	366

W

Wall hook	172
Water filter	299
Window / door alarm sensor	237
Wireless Alarm System "Feel Safe"	232

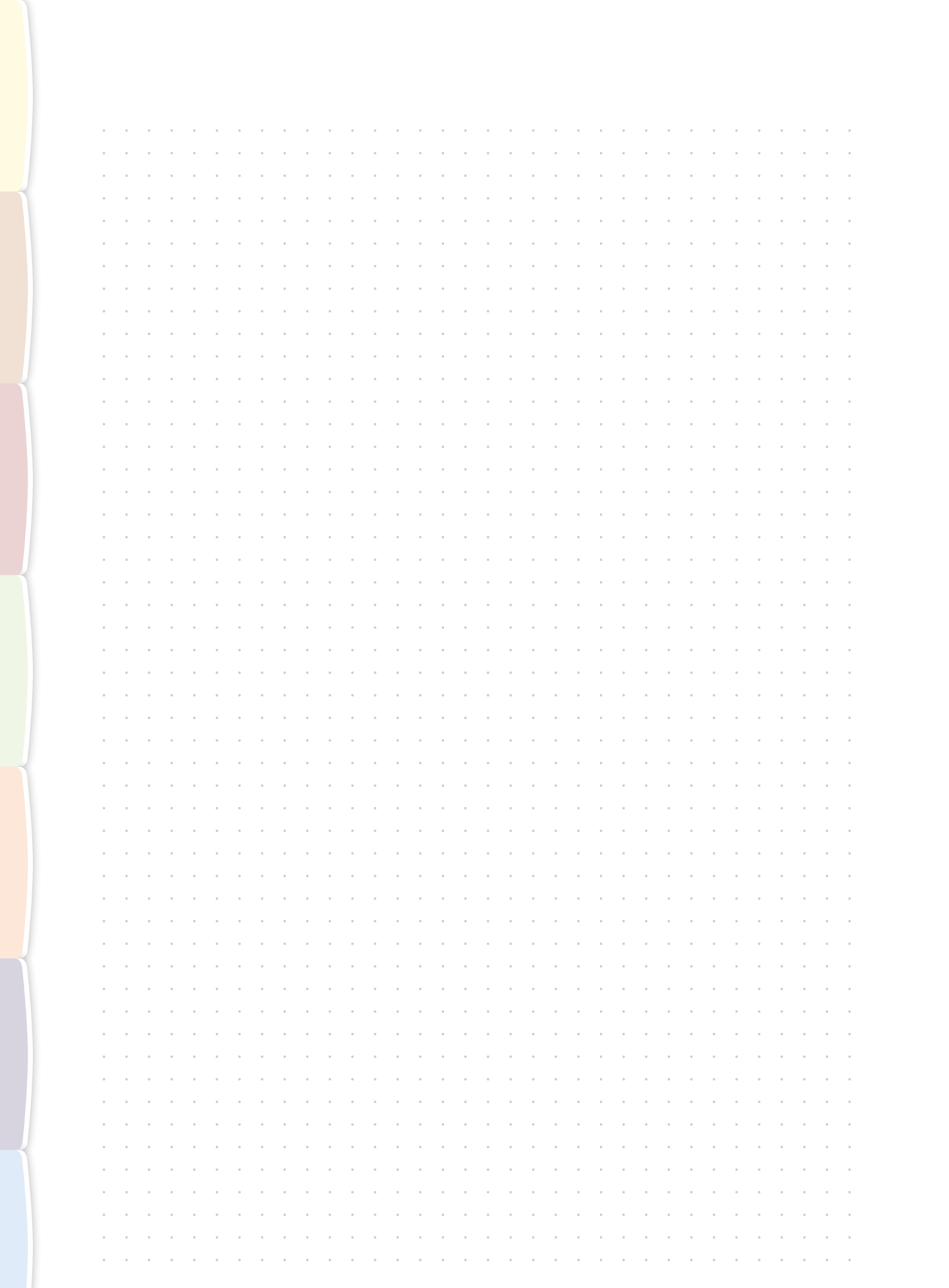

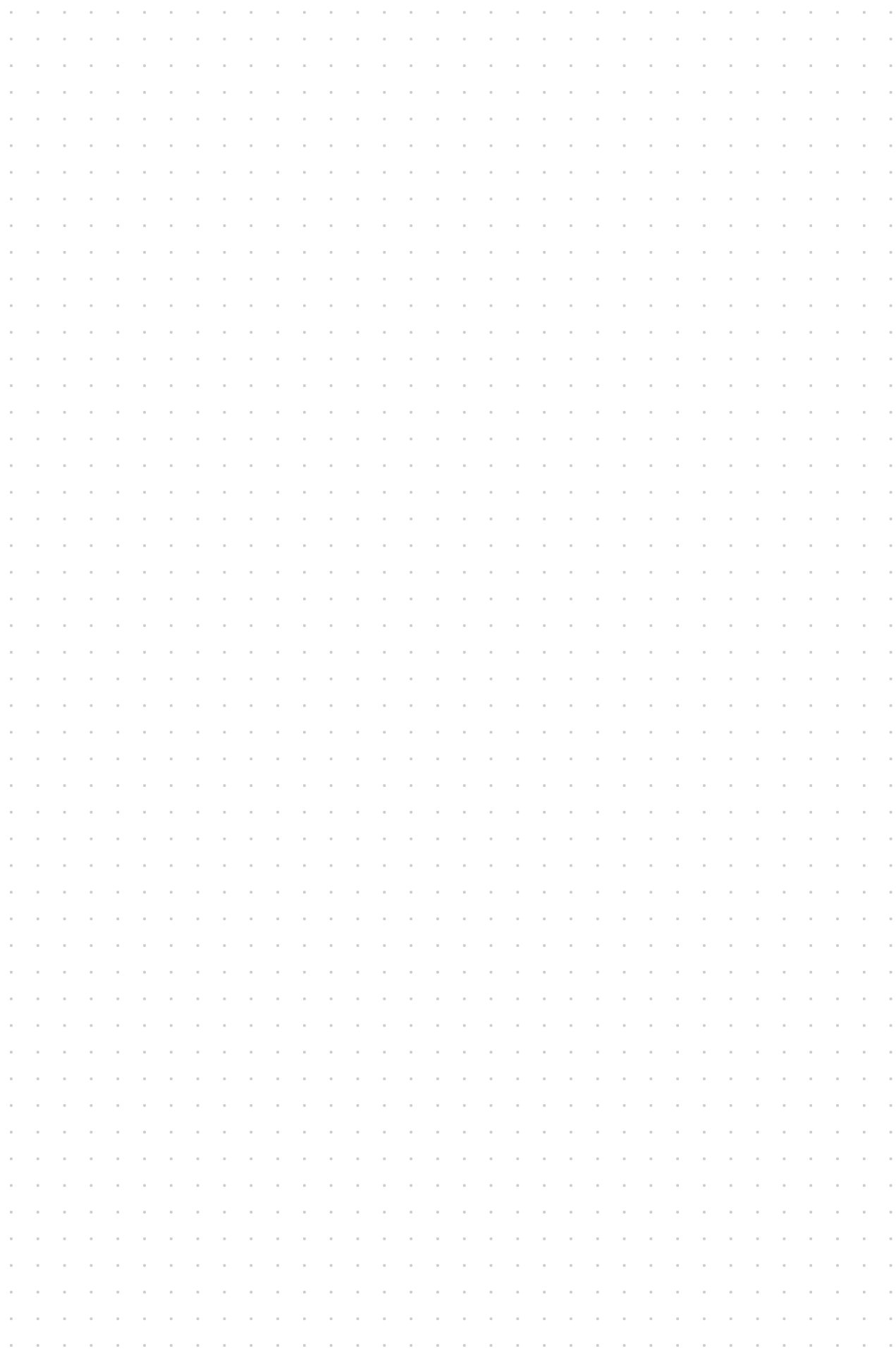

Accessories for household appliances

Energy & Technology

Cleaning & Care

Small household appliances

Household goods & Decoration

Coffee & Tea

Lighting





Qty Quantity

MOQ Minimum order quantity

PT Packaging type

BC Blister card

CB Packed in cardboard box

HT Hangtag

PO Polybag

BA Banderol

000 x 000 Blister card size: width x height in mm

Item no. Item number

Made and distributed by
Hama GmbH & Co KG
Dresdner Str. 9, 86653
Monheim/Germany
www.xavax.eu

All listed brands are trademarks of the
respective companies.
Errors and omissions excepted,
and subject to technical changes.
Our general terms of business are applied.
The depicted articles are
colour patterns which may slightly differ
from the original.

Printed in Germany.

