

# Photo & Video

November 2023



***hama***

# Brand Overview

***hama***

## Explanation of footnotes

**item no.** item number

**Qty** quantity

**MB** minimum order

**PT** packaging type

**BC** blister size

**PO** polybag

**HT** hangtag

**CB** packed in cardboard box

**BA** banderol

**HC** hangcard

**ET** Label

**SU** Sleeve

**HB** hangbox

size specifications: W x D x H (width x depth x height)

# Contents

|   |     |
|---|-----|
| Bags & Backbags .....                   | 5   |
| ActionCam-/GoPro Accessories .....      | 29  |
| Smartphone/Tablet Photo Accessories ... | 35  |
| Tripods & Accessories.....              | 45  |
| Filter & Accessories .....              | 57  |
| Accessories for Lenses .....            | 65  |
| Camera Accessories .....                | 71  |
| Energy .....                            | 81  |
| Accessories for Flashes.....            | 89  |
| Clean & Care .....                      | 91  |
| Storage Media & Accessories .....       | 97  |
| Slide .....                             | 139 |
| Cinefilm & Video.....                   | 141 |
| Projection .....                        | 143 |
| Storage Systeme .....                   | 147 |
| Cutting Machines .....                  | 151 |
| Photo-Studio.....                       | 153 |
| Optical Products .....                  | 169 |
| Index .....                             | 172 |



# Bags & Backbags



# Photo Bag



COMPACT & COLT BAGS

## Compact Bag



**hama**

Compact Bag  
"Hardcase Ambato 60M"

|                             |                              |
|-----------------------------|------------------------------|
| Material                    | Ethylene Vinyl Acetate (EVA) |
| Inside Dimensions W x D x H | 6,5 x 4,5 x 11 cm            |

- Robust EVA outer shell
- Opening with double zip fastener
- Flat interior compartment for storage media
- Removable neck strap with snap hook fastener
- Belt loop for more carrying comfort

|        |          |
|--------|----------|
| Yellow | 00121312 |
| Grey   | 00121311 |
| Black  | 00121310 |
|        | 10 HC    |



**hama**

Compact Bag  
"Hardcase Ambato 80M"

|                             |                     |
|-----------------------------|---------------------|
| Inside Dimensions W x D x H | 7,5 x 4,5 x 12,5 cm |
|-----------------------------|---------------------|

- Robust EVA outer shell
- Opening with double zip fastener
- Flat interior compartment for storage media
- Removable neck strap with snap hook fastener
- Belt loop for more carrying comfort
- With flap guard, so the camera can't fall out when the bag is open

|        |          |
|--------|----------|
| Yellow | 00121315 |
| Grey   | 00121314 |
| Black  | 00121313 |
|        | 10 HC    |



**hama**

Compact Bag  
"Hardcase Ambato 80R"

|                             |                              |
|-----------------------------|------------------------------|
| Material                    | Ethylene Vinyl Acetate (EVA) |
| Inside Dimensions W x D x H | 12 x 6 x 7 cm                |

- Sturdy EVA outer shell for secure camera protection
- Inner compartment for storage media, etc.
- Two variable inner dividers
- With detachable shoulder strap
- Quick-grab handle
- Belt loops

|        |          |
|--------|----------|
| Yellow | 00121318 |
| Grey   | 00121317 |
| Black  | 00121316 |
|        | 10 HC    |



**hama**

"Hardcase Carbon Style"  
Camera Bag, 60 H, black

|                             |                              |
|-----------------------------|------------------------------|
| Material                    | Ethylene Vinyl Acetate (EVA) |
| Inside Dimensions W x D x H | 6,5 x 3 x 10,5 cm            |

- Made of sturdy EVA material
- Flat inner compartment for storage media
- With removable neck strap with snap hook
- Belt loop for carrying convenience

|       |          |
|-------|----------|
| Black | 00023139 |
|       | 10 HC    |



**hama**

"Hardcase Carbon Style"  
Camera Bag, 60 L, black

|                             |               |
|-----------------------------|---------------|
| Inside Dimensions W x D x H | 7 x 4 x 11 cm |
|-----------------------------|---------------|

- Made of sturdy EVA material
- Flat inner compartment for storage media
- With removable neck strap with snap hook
- Belt loop for carrying convenience

|       |          |
|-------|----------|
| Black | 00023142 |
|       | 10 HC    |



**hama**

"Hardcase Colour Style"  
Camera Bag, 60 H, black

|                             |                              |
|-----------------------------|------------------------------|
| Material                    | Ethylene Vinyl Acetate (EVA) |
| Inside Dimensions W x D x H | 6,5 x 3 x 10,5 cm            |

- Made of sturdy EVA material
- Flat inner compartment for storage media
- With removable neck strap with snap hook
- Belt loop for carrying convenience

|       |          |
|-------|----------|
| Black | 00103690 |
|       | 10 HC    |



**hama**

"Hardcase Colour Style"  
Camera Bag, 60 L, black

|                             |               |
|-----------------------------|---------------|
| Inside Dimensions W x D x H | 7 x 4 x 11 cm |
|-----------------------------|---------------|

- Made of sturdy EVA material
- Flat inner compartment for storage media
- With removable neck strap with snap hook
- Belt loop for carrying convenience

|       |          |
|-------|----------|
| Black | 00103691 |
|       | 10 HC    |



**hama**

Compact Bag  
"Hardcase Colour Style 80L"

|                             |                 |
|-----------------------------|-----------------|
| Inside Dimensions W x D x H | 7 x 4 x 12,5 cm |
|-----------------------------|-----------------|

- Made of sturdy EVA material
- Flat inner compartment for storage media
- With removable neck strap with snap hook
- Belt loop for carrying convenience

|       |          |
|-------|----------|
| Black | 00103860 |
|       | 10 HC    |



**hama**

**"Hardcase Colour Style"  
Camera Bag, 80M, black**

|                             |                     |
|-----------------------------|---------------------|
| Inside Dimensions W x D x H | 7,5 x 4,5 x 12,5 cm |
|-----------------------------|---------------------|

- Made of tough EVA material
- Flat inner compartment for storage media
- Padded lining for protecting the camera from shocks
- Removable neck strap with a snap hook
- Belt loop for easy, comfortable carrying

|       |          |
|-------|----------|
| Black | 00126656 |
| 10 HC |          |



**hama**

**Compact Bag  
"Hardcase Trinidad 60M"**

|                             |                   |
|-----------------------------|-------------------|
| Material                    | Polyester         |
| Inside Dimensions W x D x H | 6,5 x 4,5 x 11 cm |

- Robust EVA outer shell
- Opening with double zip fastener
- Flat interior compartment for storage media
- Removable neck strap with snap hook fastener
- Belt loop for more carrying comfort

|       |          |
|-------|----------|
| Grey  | 00185053 |
| 10 HC |          |



**hama**

**Compact Bag  
"Fancy Sporty 60H"**

|                             |                    |
|-----------------------------|--------------------|
| Material                    | Polyester, Ripstop |
| Inside Dimensions W x D x H | 6,5 x 3 x 11 cm    |

- Main compartment with double zipper opening
- Extra zipped compartment on the lid for memory cards and batteries
- Neck strap with a snap hook
- Belt loop for convenient carrying
- The inside lining is made of soft fleece and protects the camera from scratches

|       |          |
|-------|----------|
| Black | 00139818 |
| 10 HC |          |



**hama**

**Compact Bag  
"Fancy Urban 60H"**

|                             |                    |
|-----------------------------|--------------------|
| Material                    | Polyester, Ripstop |
| Inside Dimensions W x D x H | 6,5 x 3 x 11 cm    |

- Main compartment with double zipper opening
- Extra zipped compartment on the lid for memory cards and batteries
- Neck strap with a snap hook
- Belt loop for convenient carrying
- The inside lining is made of soft fleece and protects the camera from scratches

|       |          |
|-------|----------|
| Black | 00139822 |
| 10 HC |          |



**hama**

**"Hardcase Zip" Camera Bag,  
80 M, black/blue**

|                             |                              |
|-----------------------------|------------------------------|
| Material                    | Ethylene Vinyl Acetate (EVA) |
| Inside Dimensions W x D x H | 7,5 x 4,5 x 12,5 cm          |

- Robust EVA outer shell
- Dual zipper opening
- Flat inner compartment for storage media
- Removable neck strap with a snap hook
- Belt loop for carrying convenience

|             |          |
|-------------|----------|
| Black, Blue | 00139835 |
| 10 HC       |          |



**hama**

**"Fancy Neoprene Quad"  
Camera Bag, 70E, black**

|                             |                   |
|-----------------------------|-------------------|
| Material                    | Neoprene          |
| Inside Dimensions W x D x H | 7,5 x 2 x 11,5 cm |

- Double zipper opening
- Inner compartment made of fleece which protects the camera body from scratches
- Flexible neoprene material with stretch effect

|       |          |
|-------|----------|
| Black | 00126659 |
| 10 HC |          |



**hama**

**Compact Bag  
"Fancy Sporty 80M"**

|                             |                     |
|-----------------------------|---------------------|
| Material                    | Polyester, Ripstop  |
| Inside Dimensions W x D x H | 7,5 x 4,5 x 12,5 cm |

- Main compartment with double zipper opening
- Extra zipped compartment on the lid for memory cards and batteries
- Neck strap with a snap hook
- Belt loop for convenient carrying
- The inside lining is made of soft fleece and protects the camera from scratches

|       |          |
|-------|----------|
| Black | 00139820 |
| 10 HC |          |



**hama**

**Compact Bag  
"Fancy Urban 80M"**

|                             |                     |
|-----------------------------|---------------------|
| Material                    | Polyester, Ripstop  |
| Inside Dimensions W x D x H | 7,5 x 4,5 x 12,5 cm |

- Main compartment with double zipper opening
- Extra zipped compartment on the lid for memory cards and batteries
- Neck strap with a snap hook
- Belt loop for convenient carrying
- The inside lining is made of soft fleece and protects the camera from scratches

|       |          |
|-------|----------|
| Grey  | 00139825 |
| Black | 00139824 |
| 10 HC |          |

# Photo Bag



COMPACT & COLT BAGS



**hama**

"Matera" Camera Bag, 60H, black

| Material                    | Recycled Polyester (R-PET) |
|-----------------------------|----------------------------|
| Inside Dimensions W x D x H | 6,5 x 3 x 11 cm            |

- Both the inner and outer material are made from 100% recycled polyester
- Resource-sparing production from recycled PET materials that can be processed into yarn
- Main compartment with dual-zip opening
- Special compartment on the cover for memory cards and batteries

|       |          |
|-------|----------|
| Black | 00121332 |
|       | 10 HC    |



**hama**

"Samara" Camera Bag, 40H, black

| Material                    | Polytex, Polytex (600D) |
|-----------------------------|-------------------------|
| Inside Dimensions W x D x H | 6 x 3 x 9.5 cm          |

- Zip opening
- Belt loop (45 mm wide) for more carrying comfort
- Cut-out for camera strap on the back of the bag
- Soft fleece inside lining to protect the camera from scratches
- Small internal fleece pocket, e.g. for memory cards or batteries

|       |          |
|-------|----------|
| Black | 00185079 |
|       | 10 HC    |



**hama**

"Samara" Camera Bag, 60L, black

| Material                    | Polytex (600D) |
|-----------------------------|----------------|
| Inside Dimensions W x D x H | 6 x 4 x 11 cm  |

- Zip opening
- Belt loop for more carrying comfort
- Cut-out for camera strap on the back of the bag
- Soft fleece inside lining to protect the camera from scratches
- Small internal fleece pocket, e.g. for memory cards or batteries

|       |          |
|-------|----------|
| Black | 00185081 |
|       | 40 HC    |



**hama**

"Terra" Camera Bag, 90 M, grey

| Material                    | Recycled Polyester (R-PET) |
|-----------------------------|----------------------------|
| Inside Dimensions W x D x H | 7.5 x 4.5 x 13 cm          |

- The "Terra" range is synonymous with sustainable, high-quality products that are good for both you and the environment
- Both the inner and outer material are made from 100% recycled polyester
- Resource-sparing production from recycled PET materials that can be processed into yarn

|      |          |
|------|----------|
| Grey | 00121302 |
|      | 10 HC    |



**hama**

"Matera" Camera Bag, 90M, black

| Material                    | Recycled Polyester (R-PET) |
|-----------------------------|----------------------------|
| Inside Dimensions W x D x H | 7.5 x 4.5 x 13 cm          |

- Both the inner and outer material are made from 100% recycled polyester
- Resource-sparing production from recycled PET materials that can be processed into yarn
- Main compartment with dual-zip opening
- Special compartment on the cover for memory cards and batteries

|       |          |
|-------|----------|
| Black | 00121333 |
|       | 10 HC    |



**hama**

"Samara" Camera Bag, 60G, black

| Material                    | Polytex (600D)    |
|-----------------------------|-------------------|
| Inside Dimensions W x D x H | 6 x 2.5 x 10.5 cm |

- Zip opening
- Belt loop (40 mm wide) for more carrying comfort
- Cut-out for camera strap on the back of the bag
- Soft fleece inside lining to protect the camera from scratches
- Small internal fleece pocket, e.g. for memory cards or batteries

|       |          |
|-------|----------|
| Black | 00185080 |
|       | 10 HC    |



**hama**

"Terra" Camera Bag, 60 H, grey

| Material                    | Recycled Polyester (R-PET) |
|-----------------------------|----------------------------|
| Inside Dimensions W x D x H | 6,5 x 3 x 11 cm            |

- The "Terra" range is synonymous with sustainable, high-quality products that are good for both you and the environment
- Both the inner and outer material are made from 100% recycled polyester
- Resource-sparing production from recycled PET materials that can be processed into yarn

|      |          |
|------|----------|
| Grey | 00121301 |
|      | 10 HC    |



**hama**

Compact Bag "Trinidad 60H"

| Material                    | Polyester       |
|-----------------------------|-----------------|
| Inside Dimensions W x D x H | 6,5 x 3 x 11 cm |

- Main compartment with dual-zip opening
- Special zipped compartment on the cover for memory cards and batteries
- Neck strap with snap hook fastening
- Belt loop for more carrying comfort

|       |          |
|-------|----------|
| Red   | 00185043 |
| Blue  | 00185044 |
| Grey  | 00185045 |
| Black | 00185042 |
|       | 10 HC    |





**hama**

**"Valletta" Camera Bag, 60G, black**

|                             |                   |
|-----------------------------|-------------------|
| Material                    | Polytex           |
| Inside Dimensions W x D x H | 6 x 2.5 x 10.5 cm |

- Belt loop for carrying comfort
- Cover flap with hook and loop fastener

|       |    |    |  |                 |
|-------|----|----|--|-----------------|
| Black |    |    |  | <b>00185068</b> |
|       | 10 | HC |  |                 |



**hama**

**"Valletta" Camera Bag, 90P, black**

|                             |                   |
|-----------------------------|-------------------|
| Material                    | Polytex           |
| Inside Dimensions W x D x H | 7.5 x 5.2 x 13 cm |

- Cover flap with hook and loop fastener
- Additional front compartment with zip fastener
- Detachable shoulder strap
- Belt loop for carrying comfort

|       |    |    |  |                 |
|-------|----|----|--|-----------------|
| Black |    |    |  | <b>00185070</b> |
|       | 10 | HC |  |                 |



**hama**

**"Valletta" Camera Bag, 60L, black**

|                             |               |
|-----------------------------|---------------|
| Material                    | Polytex       |
| Inside Dimensions W x D x H | 6 x 4 x 11 cm |

- Belt loop for carrying comfort
- Cover flap with hook and loop fastener

|       |    |    |  |                 |
|-------|----|----|--|-----------------|
| Black |    |    |  | <b>00185069</b> |
|       | 10 | HC |  |                 |

# Photo Bag



Colt Bag

COMPACT & COLT BAGS



**hama**

"Matera" Camera Bag,  
100 Colt, black

|                             |                            |
|-----------------------------|----------------------------|
| Material                    | Recycled Polyester (R-PET) |
| Inside Dimensions W x D x H | 13.5 x 9.5 x 12 cm         |
| Weight                      | 230 g                      |

- Both the inner and outer material are made from 100% recycled polyester
- Resource-sparing production from recycled PET materials that can be processed into yarn
- Double-zipper opening for easy handling
- Compartment under the cover for storage media and accessories
- Front compartment with zip fastener
- 2 side compartments
- Wipeable base
- Detachable shoulder strap
- Belt loop for easy carrying
- Quick-grab handle
- 2 adjustable inner dividers

|       |    |    |  |                 |
|-------|----|----|--|-----------------|
| Black |    |    |  | <b>00121335</b> |
|       | 18 | HT |  |                 |



**hama**

"Matera" Camera Bag,  
110 Colt, black

|                             |                            |
|-----------------------------|----------------------------|
| Material                    | Recycled Polyester (R-PET) |
| Inside Dimensions W x D x H | 16 x 10 x 16 cm            |
| Weight                      | 300 g                      |

- Both the inner and outer material are made from 100% recycled polyester
- Resource-sparing production from recycled PET materials that can be processed into yarn
- Double-zipper opening for easy handling
- Compartment under the cover for storage media and accessories
- Front compartment with zip fastener
- 2 side compartments
- Wipeable base
- Detachable shoulder strap
- Belt loop for easy carrying
- Quick-grab handle
- 2 adjustable inner dividers

|       |    |    |  |                 |
|-------|----|----|--|-----------------|
| Black |    |    |  | <b>00121336</b> |
|       | 12 | HT |  |                 |



**hama**

"Monterey" Camera Bag,  
100 Colt, black

|                             |                    |
|-----------------------------|--------------------|
| Material                    | Polytex            |
| Inside Dimensions W x D x H | 13.5 x 9.5 x 12 cm |
| Weight                      | 325 g              |

- High-quality camera bag in classic design
- Cover construction with zip that opens away from the body
- Soft fleece inside lining to protect the camera from scratches
- Compartment for memory cards, etc. under the cover
- Zipped compartment on the outside for storage media and batteries
- Two side mesh pockets
- Document compartment on the back
- Belt loop for more carrying comfort
- Length-adjustable, removable shoulder strap
- Soft handle
- Rain protection hood integrated into the lower part of the back section
- Wipeable base

|       |    |    |  |                 |
|-------|----|----|--|-----------------|
| Black |    |    |  | <b>00139894</b> |
|       | 18 | HT |  |                 |



**hama**

"Samara" Camera Bag,  
90 Colt, black

|                             |                |
|-----------------------------|----------------|
| Material                    | Polytex (600D) |
| Inside Dimensions W x D x H | 13 x 8 x 11 cm |
| Weight                      | 170 g          |

- Double-zip opening for quick access
- Patch zipped front pocket for accessories
- Length-adjustable shoulder strap
- Handle
- Soft fleece inside lining
- One removable inner divider

|       |    |    |  |                 |
|-------|----|----|--|-----------------|
| Black |    |    |  | <b>00185084</b> |
|       | 12 | HT |  |                 |



**hama**

"Samara" Camera Bag,  
110 Colt, black

|                             |                 |
|-----------------------------|-----------------|
| Material                    | Polytex (600D)  |
| Inside Dimensions W x D x H | 17 x 10 x 17 cm |
| Weight                      | 215 g           |

- Double-zip opening for quick access
- Patch zipped front pocket for accessories
- Length-adjustable shoulder strap
- Handle
- Soft fleece inside lining
- One removable inner divider

|       |    |    |  |                 |
|-------|----|----|--|-----------------|
| Black |    |    |  | <b>00185085</b> |
|       | 12 | HT |  |                 |



**hama**

"Zambia" Camera Bag,  
100 Colt, grey/black

|                             |                 |
|-----------------------------|-----------------|
| Material                    | Polyester       |
| Inside Dimensions W x D x H | 14 x 10 x 14 cm |
| Weight                      | 185 g           |

- Zipped compartment under the cover for storage media and accessories
- Double-zipper opening for easy handling
- Detachable shoulder strap
- Belt loop for easy carrying
- Quick-grab handle

|             |    |    |  |                 |
|-------------|----|----|--|-----------------|
| Black, Grey |    |    |  | <b>00139883</b> |
|             | 16 | HT |  |                 |



**hama**

"Terra" Camera Bag,  
100 Colt, grey

|                             |                            |
|-----------------------------|----------------------------|
| Material                    | Recycled Polyester (R-PET) |
| Inside Dimensions W x D x H | 13.5 x 9.5 x 12 cm         |
| Weight                      | 285 g                      |

- The "Terra" range is synonymous with sustainable, high-quality products that are good for both you and the environment
- Both the inner and outer material are made from 100% recycled polyester
- Resource-sparing production from recycled PET materials that can be processed into yarn
- Compartment under the cover for storage media and accessories
- Double-zipper opening for easy handling
- Front compartment with zip fastener
- Two side compartments
- Wipeable base
- Detachable shoulder strap
- Belt loop for easy carrying
- Quick-grab handle

|      |    |    |  |                 |
|------|----|----|--|-----------------|
| Grey |    |    |  | <b>00121303</b> |
|      | 18 | HT |  |                 |



**hama**

"Terra" Camera Bag, 110 Colt,  
grey

|                             |                            |
|-----------------------------|----------------------------|
| Material                    | Recycled Polyester (R-PET) |
| Inside Dimensions W x D x H | 16 x 10 x 16 cm            |
| Weight                      | 315 g                      |

- The "Terra" range is synonymous with sustainable, high-quality products that are good for both you and the environment
- Both the inner and outer material are made from 100% recycled polyester
- Resource-sparing production from recycled PET materials that can be processed into yarn
- Compartment under the cover for storage media and accessories
- Double-zipper opening for easy handling
- Front compartment with zip fastener
- Two side compartments
- Wipeable base
- Detachable shoulder strap
- Belt loop for easy carrying
- Quick-grab handle

|      |    |    |  |                 |
|------|----|----|--|-----------------|
| Grey |    |    |  | <b>00121304</b> |
|      | 12 | HT |  |                 |

# Photo Bag



COMPACT & COLT BAGS



**hama**

"Valletta" Camera Bag,  
90 Colt, black

|                             |                |
|-----------------------------|----------------|
| Material                    | Polytex        |
| Inside Dimensions W x D x H | 13 x 8 x 11 cm |
| Weight                      | 210 g          |

- Belt loop for carrying comfort
- Main compartment with zip that opens away from the body
- Additional front compartment with zip fastener
- Two side mesh pockets
- Detachable shoulder strap

|       |    |    |  |                 |
|-------|----|----|--|-----------------|
| Black |    |    |  | <b>00185076</b> |
|       | 18 | HT |  |                 |



**hama**

"Valletta" Camera Bag,  
130 Colt, black

|                             |                 |
|-----------------------------|-----------------|
| Material                    | Polytex         |
| Inside Dimensions W x D x H | 16 x 10 x 21 cm |
| Weight                      | 300 g           |

- Two belt loops for comfortable carrying
- Main compartment with zip that opens away from the body
- Additional front compartment with zip fastener
- Two side mesh pockets
- Padded handle
- Detachable shoulder strap

|       |   |    |  |                 |
|-------|---|----|--|-----------------|
| Black |   |    |  | <b>00185078</b> |
|       | 8 | HT |  |                 |



**hama**

"Valletta" Camera Bag,  
110 Colt, black

|                             |                  |
|-----------------------------|------------------|
| Material                    | Polytex          |
| Inside Dimensions W x D x H | 15 x 9 x 15.5 cm |
| Weight                      | 220 g            |

- Belt loop for carrying comfort
- Main compartment with zip that opens away from the body
- Additional front compartment with zip fastener
- Two side mesh pockets
- Padded handle
- Detachable shoulder strap

|       |    |    |  |                 |
|-------|----|----|--|-----------------|
| Black |    |    |  | <b>00185077</b> |
|       | 16 | HT |  |                 |



**hama**

"Albany HC" Camera Bag,  
110 Colt, black

|                             |                 |
|-----------------------------|-----------------|
| Inside Dimensions W x D x H | 15 x 10 x 14 cm |
| Weight                      | 280 g           |

- Main opening with two-way zip fastener
- Zipped front pocket for accessories such as cables, memory cards and batteries
- Mesh side pockets
- Belt loop for more carrying comfort
- Padded handle
- Adjustable, removable shoulder strap
- Stable bag base made from sturdy and resilient EVA material

|       |    |    |  |                 |
|-------|----|----|--|-----------------|
| Black |    |    |  | <b>00185062</b> |
|       | 12 | HT |  |                 |



COMPACT & COLT BAGS

## Organizer Bag



**hama**

**Organizer Bag "Fancy", L**

| Material                     | Polytex          |
|------------------------------|------------------|
| Outside Dimensions W x D x H | 23.5 x 17 x 8 cm |
| Inside Dimensions W x D x H  | 22.5 x 7 x 16 cm |

- The organiser offers plenty of storage space for electronic devices and photo accessories such as cables, USB sticks, filters or SD cards
- All tidied away and ready at hand, ideal for holidays and when out and about
- 2 main compartments with double zip
- 1 zipped pocket inside for power pack or filters
- 2 mesh pockets inside for mobile phones and photo accessories
- 1 mesh pocket with zip fastener in the second main compartment
- 10 rubber loops for cables, etc.
- 6 mesh pockets for USB sticks or SD cards
- Double-zipper opening

|       |  |  |  |    |    |          |
|-------|--|--|--|----|----|----------|
| Black |  |  |  | 10 | HC | 00139875 |
|-------|--|--|--|----|----|----------|

## Camera/Accessories Bag



**hama**

**Camera/Accessories Bag "Fancy", Black**

| Material                     | Polytex            |
|------------------------------|--------------------|
| Outside Dimensions W x D x H | 23.5 x 17 x 4.5 cm |
| Inside Dimensions W x D x H  | 22.5 x 3.5 x 16 cm |

- Bag with zipped opening
- Universal bag for protection against dirt and scratches

|   |  |  |    |    |  |          |
|---|--|--|----|----|--|----------|
| S |  |  |    |    |  | 00139871 |
|   |  |  | 20 | HC |  |          |
| M |  |  |    |    |  | 00139872 |
|   |  |  | 25 | HC |  |          |



**hama**

**Organizer Bag "Fancy", M**

| Material                     | Polytex            |
|------------------------------|--------------------|
| Outside Dimensions W x D x H | 23.5 x 17 x 4.5 cm |
| Inside Dimensions W x D x H  | 22.5 x 3.5 x 16 cm |

- The organiser offers plenty of storage space for photo accessories such as cables, USB sticks, filters or SD cards
- All tidied away and ready at hand, ideal for holidays and when out and about
- 1 zipped pocket for power pack or filters
- 10 rubberised loops
- 6 mesh pockets for USB sticks or SD cards
- Double-zipper opening

|       |  |  |  |    |    |          |
|-------|--|--|--|----|----|----------|
| Black |  |  |  | 20 | HC | 00139874 |
|-------|--|--|--|----|----|----------|



**hama**

**Protection/Cleaning Bag for SLR and System Cameras**

| Material                     | Microfibre         |
|------------------------------|--------------------|
| Outside Dimensions W x D x H | 23.5 x 17 x 4.5 cm |
| Inside Dimensions W x D x H  | 22.5 x 3.5 x 16 cm |

- Universal protection and cleaning bag made of microfibre material
- Can be used as a protection bag for a camera and as a cleaning cloth for displays, etc.
- Antistatic microfibre material for easy dry cleaning
- Drawcord closure (secures the camera in the bag)
- Washable at 30 degrees

|  |  |  |  |    |    |          |
|--|--|--|--|----|----|----------|
|  |  |  |  | 80 | HB | 00121898 |
|--|--|--|--|----|----|----------|

# Photo Bag



## Equipment Bag

EQUIPMENT BAGS



**hama**

"Albany HC" Camera Bag, 110, black

|                             |                 |
|-----------------------------|-----------------|
| Inside Dimensions W x D x H | 15 x 10 x 13 cm |
| Weight                      | 325 g           |

- Main opening with two-way zip fastener
- Zipped front pocket for accessories such as cables, memory cards and batteries
- Mesh side pockets
- Belt loop for more carrying comfort
- Padded handle
- Adjustable, removable shoulder strap
- An adjustable internal divider for clear organisation
- Stable bag base made from sturdy and resilient EVA material

|       |          |
|-------|----------|
| Black | 00185063 |
| 12    | HT       |



**hama**

"Albany HC" Camera Bag, 130, black

|                             |                 |
|-----------------------------|-----------------|
| Inside Dimensions W x D x H | 20 x 11 x 17 cm |
| Weight                      | 380 g           |

- Main opening with two-way zip fastener
- Zipped front pocket for accessories such as cables, memory cards and batteries
- Mesh side pockets
- Belt loops for more carrying comfort
- Padded handle
- Adjustable, removable shoulder strap
- Two adjustable inner dividers for clear organisation
- Stable bag base made from sturdy and resilient EVA material

|       |          |
|-------|----------|
| Black | 00185064 |
| 8     | HT       |



**hama**

"Albany HC" Camera Bag, 135, black

|                             |                   |
|-----------------------------|-------------------|
| Material                    | Polyester         |
| Inside Dimensions W x D x H | 22 x 12.5 x 14 cm |
| Weight                      | 440 g             |

- Main opening with two-way zip fastener
- Zipped front pocket for accessories such as cables, memory cards and batteries
- Mesh side pockets
- Belt loops for more carrying comfort
- Padded handle
- Adjustable, removable shoulder strap
- Two adjustable inner dividers for clear organisation
- Stable bag base made from sturdy and resilient EVA material

|       |          |
|-------|----------|
| Black | 00185065 |
| 8     | HT       |



**hama**

"Matera" Camera Bag, 90, black

|                             |                            |
|-----------------------------|----------------------------|
| Material                    | Recycled Polyester (R-PET) |
| Inside Dimensions W x D x H | 8 x 7.5 x 13 cm            |
| Weight                      | 225 g                      |

- Both the inner and outer material are made from 100% recycled polyester
- Resource-sparing production from recycled PET materials that can be processed into yarn
- Double-zipper opening for easy handling
- Compartment under the cover for storage media and batteries
- Front compartment with zip fastener
- 2 side compartments
- Wipeable base
- Detachable shoulder strap
- Belt loop for easy carrying
- Padded handle
- 1 adjustable inner divider

|       |          |
|-------|----------|
| Black | 00121334 |
| 32    | HT       |



**hama**

**"Matera" Camera Bag, 110, black**

| Material                    | Recycled Polyester (R-PET) |
|-----------------------------|----------------------------|
| Inside Dimensions W x D x H | 15.5 x 10 x 13 cm          |
| Weight                      | 250 g                      |

- Both the inner and outer material are made from 100% recycled polyester
- Resource-sparing production from recycled PET materials that can be processed into yarn
- Double-zipper opening for easy handling
- Compartment under the cover for storage media and accessories
- Front compartment with zip fastener
- 2 side compartments
- Wipeable base
- Detachable shoulder strap
- Belt loop for easy carrying
- Quick-grab handle
- 1 adjustable inner divider

|       |          |
|-------|----------|
| Black | 00121337 |
| 18    | HT       |



**hama**

**"Matera" Camera Bag, 130, black**

| Material                    | Recycled Polyester (R-PET) |
|-----------------------------|----------------------------|
| Inside Dimensions W x D x H | 20 x 10.5 x 16.5 cm        |
| Weight                      | 375 g                      |

- Both the inner and outer material are made from 100% recycled polyester
- Resource-sparing production from recycled PET materials that can be processed into yarn
- Double-zipper opening for easy handling
- Compartment under the cover for storage media and accessories
- Front compartment with zip fastener
- 2 side compartments
- Wipeable base
- Detachable shoulder strap
- Trolley strap
- Quick-grab handle
- 2 adjustable inner dividers

|       |          |
|-------|----------|
| Black | 00121338 |
| 8     | HT       |



**hama**

**"Matera" Camera Bag, 135, black**

| Material                    | Recycled Polyester (R-PET) |
|-----------------------------|----------------------------|
| Inside Dimensions W x D x H | 23 x 9.5 x 14 cm           |
| Weight                      | 350 g                      |

- Both the inner and outer material are made from 100% recycled polyester
- Resource-sparing production from recycled PET materials that can be processed into yarn
- Double-zipper opening for easy handling
- Compartment under the cover for storage media and accessories
- Front compartment with zip fastener
- 2 side compartments
- Wipeable base
- Detachable shoulder strap
- Trolley strap
- Quick-grab handle
- 2 adjustable inner dividers

|       |          |
|-------|----------|
| Black | 00121339 |
| 8     | HT       |



**hama**

**"Monterey" Camera Bag, 100, black**

| Material                    | Polytex          |
|-----------------------------|------------------|
| Inside Dimensions W x D x H | 14 x 8 x 11.5 cm |
| Weight                      | 340 g            |

- High-quality camera bag in classic design
- Cover construction with zip that opens away from the body
- Soft fleece inside lining to protect the camera from scratches
- Compartment for memory cards, etc. under the cover
- Zipped compartment on the outside for storage media and batteries
- Flat zipped compartment at the back for documents
- Two side mesh pockets
- Belt loop for more carrying comfort
- Length-adjustable, removable shoulder strap
- Handle
- 1 variable internal divider for clear organisation
- Rain protection hood integrated into the lower part of the back section
- Wipeable base

|       |          |
|-------|----------|
| Black | 00139888 |
| 16    | HT       |

# Photo Bag



EQUIPMENT BAGS



**hama**

"Pittsburgh" Camera Bag,  
100, black

| Material                    | Polyester        |
|-----------------------------|------------------|
| Inside Dimensions W x D x H | 14 x 8 x 11.5 cm |
| Weight                      | 320 g            |

- Main compartment with dual-zip opening
- Flat front pocket with two mesh compartments for e.g. batteries
- Additional zip fastener under the cover for e.g. memory cards
- Pocket on the inside of the back of the bag
- 2 external mesh compartments on the sides
- Flexible, adjustable tripod holders under the mesh pockets on the sides
- 1 variable inner divider
- 2 belt loops
- Wipeable base
- Removable and length-adjustable shoulder strap with ergonomically shaped shoulder pad
- Padded handle
- Rain protection hood in the lower part of the back section integrated with hook and eye fastener

| Black | 00185008 |
|-------|----------|
| 16    | HT       |



**hama**

"Pittsburgh" Camera Bag,  
130, black

| Material                    | Polyester       |
|-----------------------------|-----------------|
| Inside Dimensions W x D x H | 20 x 11 x 17 cm |
| Weight                      | 470 g           |

- Main compartment with dual-zip opening
- Flat front pocket with 2 mesh compartments for e.g. batteries
- Additional zip fastener under the cover for e.g. memory cards
- Zipped external compartment on the back of the bag
- Pocket on the inside of the back of the bag
- 2 external mesh compartments on the sides
- Flexible, adjustable tripod holders under the mesh pockets on the sides
- 2 variable inner dividers
- Trolley strap on the back
- Wipeable base
- Removable and length-adjustable shoulder strap with ergonomically shaped shoulder pad
- Padded handle
- Rain protection hood in the lower part of the back section integrated with hook and eye fastener

| Black | 00185009 |
|-------|----------|
| 8     | HT       |



**hama**

"Pittsburgh" Camera Bag,  
140, black

| Material                    | Polyester           |
|-----------------------------|---------------------|
| Inside Dimensions W x D x H | 23 x 12.5 x 18.5 cm |
| Weight                      | 520 g               |

- Main compartment with dual-zip opening
- Flat front pocket with 2 mesh compartments for e.g. batteries
- Additional zip fastener under the cover for e.g. memory cards
- Zipped compartment on the back of the bag
- Pocket on the inside of the back of the bag
- 2 external mesh compartments on the sides
- Flexible, adjustable tripod holders under the mesh pockets on the sides
- 2 variable inner dividers
- Trolley strap on the back
- Wipeable base
- Removable and length-adjustable shoulder strap with ergonomically shaped shoulder pad
- Padded handle
- Rain protection hood in the lower part of the back section integrated with hook and eye fastener

| Black | 00185011 |
|-------|----------|
| 8     | HT       |



**hama**

"Pittsburgh" Camera Bag,  
150, black

| Material                    | Polyester       |
|-----------------------------|-----------------|
| Inside Dimensions W x D x H | 24 x 15 x 20 cm |
| Weight                      | 625 g           |

- Main compartment with dual-zip opening
- Flat front pocket with 2 mesh compartments for e.g. batteries
- Additional zip fastener under the cover for e.g. memory cards
- Zipped compartment on the back of the bag
- Pocket on the inside of the back of the bag for a tablet
- 2 external mesh compartments on the sides
- Flexible, adjustable tripod holders under the mesh pockets on the sides
- 4 variable inner dividers
- Trolley strap on the back
- Wipeable base
- Removable and length-adjustable shoulder strap with ergonomically shaped shoulder pad
- Padded handle
- Rain protection hood in the lower part of the back section integrated with hook and eye fastener

| Black | 00185058 |
|-------|----------|
| 4     | HT       |





**hama**

"Pittsburgh" Camera Bag, 170, black

| Material                    | Polyester       |
|-----------------------------|-----------------|
| Inside Dimensions W x D x H | 29 x 16 x 20 cm |
| Weight                      | 725 g           |

- Main compartment with dual-zip opening
- Flat front pocket with 2 mesh compartments for e.g. batteries
- Additional zip fastener under the cover for e.g. memory cards
- Zipped compartment on the back of the bag
- Pocket on the inside of the back of the bag for a tablet
- 2 external mesh compartments on the sides
- Flexible, adjustable tripod holders under the mesh pockets on the sides
- 6 variable inner dividers
- Trolley strap on the back
- Wipeable base
- Removable and length-adjustable shoulder strap with ergonomically shaped shoulder pad
- Padded handle
- Rain protection hood in the lower part of the back section integrated with hook and eye fastener

| Black | 00185059 |
|-------|----------|
| 4     | HT       |



**hama**

"Pittsburgh" Camera Bag, 200, black

| Material                    | Polyester         |
|-----------------------------|-------------------|
| Inside Dimensions W x D x H | 34.5 x 18 x 23 cm |
| Weight                      | 875 g             |

- Main compartment with dual-zip opening
- Flat front pocket with 2 mesh compartments for e.g. batteries
- Additional zip fastener under the cover for e.g. memory cards
- Zipped compartment on the back of the bag
- Pocket on the inside of the back of the bag for a tablet
- 2 external mesh compartments on the sides
- Flexible, adjustable tripod holders under the mesh pockets on the sides
- 7 variable inner dividers
- Trolley strap on the back
- Wipeable base
- Removable and length-adjustable shoulder strap with ergonomically shaped shoulder pad
- Padded handle
- Rain protection hood in the lower part of the back section integrated with hook and eye fastener

| Black | 00185060 |
|-------|----------|
| 2     | HT       |



**hama**

"Phoenix" Camera Bag, 130, black

| Material                    | Recycled Polyester (R-PET) |
|-----------------------------|----------------------------|
| Inside Dimensions W x D x H | 23.5 x 16.5 x 20 cm        |
| Weight                      | 460 g                      |

- Main compartment with dual-zip opening
- Flat front pocket with 3 mesh compartments for e.g. batteries
- Zipped compartment on the cover
- Additional zip fastener under the cover for e.g. memory cards
- Zipped external compartment on the back of the bag
- Pocket on the inside of the back of the bag
- 2 external mesh compartments on the sides
- Flexible, adjustable tripod holders under the mesh pockets on the sides
- 2 variable inner dividers
- Trolley strap on the back
- Wipeable base
- Removable and length-adjustable shoulder strap with ergonomically shaped shoulder pad
- Padded handle
- Rain protection hood integrated into the lower part of the back section

|   | 00121348 |
|---|----------|
| 8 | HT       |



**hama**

"Phoenix" Camera Bag, 135, black

| Material                    | Recycled Polyester (R-PET) |
|-----------------------------|----------------------------|
| Inside Dimensions W x D x H | 26 x 16 x 17.5 cm          |
| Weight                      | 480 g                      |

- Main compartment with dual-zip opening
- Flat front pocket with 2 mesh compartments for e.g. batteries
- Zipped compartment on the cover
- Additional zip fastener under the cover for e.g. memory cards
- Zipped compartment on the back of the bag
- Pocket on the inside of the back of the bag
- 2 external mesh compartments on the sides
- Flexible, adjustable tripod holders under the mesh pockets on the sides
- 2 variable inner dividers
- Trolley strap on the back
- Wipeable base
- Removable and length-adjustable shoulder strap with ergonomically shaped shoulder pad
- Padded handle
- Rain protection hood integrated into the lower part of the back section

|   | 00121349 |
|---|----------|
| 8 | HT       |



EQUIPMENT BAGS



**hama**

"Phoenix" Camera Bag, 140, black

|                             |                            |
|-----------------------------|----------------------------|
| Material                    | Recycled Polyester (R-PET) |
| Inside Dimensions W x D x H | 26 x 16.5 x 21 cm          |
| Weight                      | 500 g                      |

- Main compartment with dual-zip opening
- Flat front pocket with 2 mesh compartments for e.g. batteries
- Zipped compartment on the cover
- Additional zip fastener under the cover for e.g. memory cards
- Zipped compartment on the back of the bag
- Pocket on the inside of the back of the bag
- 2 external mesh compartments on the sides
- Flexible, adjustable tripod holders under the mesh pockets on the sides
- 2 variable inner dividers
- Trolley strap on the back
- Wipeable base
- Removable and length-adjustable shoulder strap with ergonomically shaped shoulder pad
- Padded handle
- Rain protection hood integrated into the lower part of the back section

|          |    |  |
|----------|----|--|
| 00121350 |    |  |
| 8        | HT |  |



**hama**

"Phoenix" Camera Bag, 170, black

|                             |                            |
|-----------------------------|----------------------------|
| Material                    | Recycled Polyester (R-PET) |
| Inside Dimensions W x D x H | 36 x 22 x 23 cm            |
| Weight                      | 700 g                      |

- Main compartment with dual-zip opening
- Flat front pocket with 3 mesh compartments for e.g. batteries
- Zipped compartment on the cover
- Additional zip fastener under the cover for e.g. memory cards
- Zipped compartment on the back of the bag
- Pocket on the inside of the back of the bag for a tablet
- 2 external mesh compartments on the sides
- Flexible, adjustable tripod holders under the mesh pockets on the sides
- 7 variable inner dividers
- Trolley strap on the back
- Wipeable base
- Removable and length-adjustable shoulder strap with ergonomically shaped shoulder pad
- Padded handle
- Rain protection hood integrated into the lower part of the back section

|          |    |  |
|----------|----|--|
| 00121351 |    |  |
| 4        | HT |  |



**hama**

"Phoenix" Camera Bag, 200, black

|                             |                            |
|-----------------------------|----------------------------|
| Material                    | Recycled Polyester (R-PET) |
| Inside Dimensions W x D x H | 38 x 22 x 27 cm            |
| Weight                      | 800 g                      |

- Main compartment with dual-zip opening
- Flat front pocket with 3 mesh compartments for e.g. batteries
- Zipped compartment on the cover
- Additional zip fastener under the cover for e.g. memory cards
- Zipped compartment on the back of the bag
- Pocket on the inside of the back of the bag for a tablet
- 2 external mesh compartments on the sides
- Flexible, adjustable tripod holders under the mesh pockets on the sides
- 7 variable inner dividers
- Trolley strap on the back
- Wipeable base
- Removable and length-adjustable shoulder strap with ergonomically shaped shoulder pad
- Padded handle
- Rain protection hood integrated into the lower part of the back section

|          |    |  |
|----------|----|--|
| 00121352 |    |  |
| 2        | HT |  |



**hama**

"Samara" Camera Bag, 90, black

|                             |                 |
|-----------------------------|-----------------|
| Material                    | Polytex (600D)  |
| Inside Dimensions W x D x H | 13 x 7 x 7.5 cm |
| Weight                      | 135 g           |

- Double-zip opening for quick access
- Patch zipped front pocket for accessories
- Length-adjustable shoulder strap
- Handle

|       |          |    |
|-------|----------|----|
| Black | 00185082 |    |
|       | 10       | HT |



**hama**

"Samara" Camera Bag, 100, black

|                             |                      |
|-----------------------------|----------------------|
| Material                    | Polytex (600D)       |
| Inside Dimensions W x D x H | 14.5 x 7.5 x 10.5 cm |
| Weight                      | 175 g                |

- Double-zip opening for quick access
- Patch zipped front pocket for accessories
- Length-adjustable shoulder strap
- Handle
- Soft fleece inside lining
- One removable inner divider

|       |    |    |  |                 |
|-------|----|----|--|-----------------|
| Black |    |    |  | <b>00185083</b> |
|       | 12 | HT |  |                 |



**hama**

"Samara" Camera Bag, 110, black

|                             |                 |
|-----------------------------|-----------------|
| Material                    | Polytex (600D)  |
| Inside Dimensions W x D x H | 16 x 10 x 13 cm |
| Weight                      | 215 g           |

- Double-zip opening for quick access
- Patch zipped front pocket for accessories
- Length-adjustable shoulder strap
- Handle
- Soft fleece inside lining
- One removable inner divider

|       |   |    |  |                 |
|-------|---|----|--|-----------------|
| Black |   |    |  | <b>00185086</b> |
|       | 8 | HT |  |                 |



**hama**

"Samara" Camera Bag, 140, black

|                             |                 |
|-----------------------------|-----------------|
| Material                    | Polytex (600D)  |
| Inside Dimensions W x D x H | 23 x 11 x 16 cm |
| Weight                      | 300 g           |

- Double-zip opening for quick access
- Patch zipped front pocket for accessories
- Length-adjustable shoulder strap
- Handle
- Soft fleece inside lining
- One removable inner divider

|       |   |    |  |                 |
|-------|---|----|--|-----------------|
| Black |   |    |  | <b>00185087</b> |
|       | 6 | HT |  |                 |



**hama**

"Terra" Camera Bag, 90, grey

|                             |                            |
|-----------------------------|----------------------------|
| Material                    | Recycled Polyester (R-PET) |
| Inside Dimensions W x D x H | 8 x 7.5 x 13 cm            |
| Weight                      | 225 g                      |

- The "Terra" range is synonymous with sustainable, high-quality products that are good for both you and the environment
- Both the inner and outer material are made from 100% recycled polyester
- Resource-sparing production from recycled PET materials that can be processed into yarn
- Compartment under the cover for storage media
- Double-zipper opening for easy handling
- Front compartment
- Two side compartments
- Wipeable base
- Detachable shoulder strap
- Belt loop for easy carrying

|      |    |    |  |                 |
|------|----|----|--|-----------------|
| Grey |    |    |  | <b>00121305</b> |
|      | 32 | HT |  |                 |

# Photo Bag



EQUIPMENT BAGS



**hama**

"Terra" Camera Bag, 110, grey

|                             |                            |
|-----------------------------|----------------------------|
| Material                    | Recycled Polyester (R-PET) |
| Inside Dimensions W x D x H | 15.5 x 10 x 13 cm          |
| Weight                      | 340 g                      |

- The "Terra" range is synonymous with sustainable, high-quality products that are good for both you and the environment
- Both the inner and outer material are made from 100% recycled polyester
- Resource-sparing production from recycled PET materials that can be processed into yarn
- Compartment under the cover for storage media and accessories
- Double-zipper opening for easy handling
- Front compartment with zip fastener
- Two side compartments
- Wipeable base
- Detachable shoulder strap
- Belt loop for easy carrying
- Quick-grab handle
- 1 adjustable inner divider

|      |          |
|------|----------|
| Grey | 00121306 |
| 18   | HT       |



**hama**

"Terra" Camera Bag, 130, grey

|                             |                            |
|-----------------------------|----------------------------|
| Material                    | Recycled Polyester (R-PET) |
| Inside Dimensions W x D x H | 20 x 10.5 x 16.5 cm        |
| Weight                      | 375 g                      |

- The "Terra" range is synonymous with sustainable, high-quality products that are good for both you and the environment
- Both the inner and outer material are made from 100% recycled polyester
- Resource-sparing production from recycled PET materials that can be processed into yarn
- Compartment under the cover for storage media and accessories
- Double-zipper opening for easy handling
- Front compartment with zip fastener
- Two side compartments
- Wipeable base
- Detachable shoulder strap
- Trolley strap
- Quick-grab handle
- 1 adjustable inner divider

|      |          |
|------|----------|
| Grey | 00121307 |
| 8    | HT       |



**hama**

"Terra" Camera Bag, 135, grey

|                             |                            |
|-----------------------------|----------------------------|
| Material                    | Recycled Polyester (R-PET) |
| Inside Dimensions W x D x H | 23 x 9.5 x 14 cm           |
| Weight                      | 400 g                      |

- The "Terra" range is synonymous with sustainable, high-quality products that are good for both you and the environment
- Both the inner and outer material are made from 100% recycled polyester
- Resource-sparing production from recycled PET materials that can be processed into yarn
- Compartment under the cover for storage media and accessories
- Double-zipper opening for easy handling
- Front compartment with zip fastener
- Two side compartments
- Wipeable base
- Detachable shoulder strap
- Trolley strap
- Quick-grab handle
- 1 adjustable inner divider

|      |          |
|------|----------|
| Grey | 00121308 |
| 8    | HT       |



**hama**

"Valletta" Camera Bag, 90, black

|                             |               |
|-----------------------------|---------------|
| Material                    | Polytex       |
| Inside Dimensions W x D x H | 9 x 8 x 13 cm |
| Weight                      | 160 g         |

- Cover flap with hook and loop fastener
- Additional front compartment with zip fastener
- Detachable shoulder strap
- Belt loop for carrying comfort

|       |          |
|-------|----------|
| Black | 00185071 |
| 18    | HT       |



**hama**

"Valletta" Camera Bag, 100, black

|                             |                             |
|-----------------------------|-----------------------------|
| Material                    | Plastic Material, Polyester |
| Inside Dimensions W x D x H | 14.5 x 7.5 x 10.5 cm        |
| Weight                      | 260 g                       |

- Main compartment with zip opening
- Two mesh pockets on the sides
- Additional front compartment with zip fastener
- Two belt loops for comfortable carrying
- Padded handle
- Adjustable inner divider
- Detachable shoulder strap

|       |    |    |  |                 |
|-------|----|----|--|-----------------|
| Black |    |    |  | <b>00185072</b> |
|       | 18 | HT |  |                 |



**hama**

"Valletta" Camera Bag, 110, black

|                             |                   |
|-----------------------------|-------------------|
| Material                    | Polytex           |
| Inside Dimensions W x D x H | 15.5 x 10 x 13 cm |
| Weight                      | 310 g             |

- Main compartment with zip opening
- Two mesh pockets on the sides
- Additional front compartment with zip fastener
- Two belt loops for comfortable carrying
- Padded handle
- Adjustable inner divider
- Detachable shoulder strap

|       |    |    |  |                 |
|-------|----|----|--|-----------------|
| Black |    |    |  | <b>00185073</b> |
|       | 16 | HT |  |                 |



**hama**

"Valletta" Camera Bag, 130, black

|                             |                 |
|-----------------------------|-----------------|
| Material                    | Polyester       |
| Inside Dimensions W x D x H | 20 x 11 x 17 cm |
| Weight                      | 390 g           |

- Main compartment with zip opening
- Two mesh pockets on the sides
- Additional front compartment with zip fastener
- Two belt loops for comfortable carrying
- Padded handle
- Adjustable inner divider
- Detachable shoulder strap

|       |   |    |  |                 |
|-------|---|----|--|-----------------|
| Black |   |    |  | <b>00185074</b> |
|       | 8 | HT |  |                 |



**hama**

"Valletta" Camera Bag, 140, black

|                             |                     |
|-----------------------------|---------------------|
| Material                    | Polytex             |
| Inside Dimensions W x D x H | 22 x 11.5 x 20.5 cm |
| Weight                      | 400 g               |

- Main compartment with zip opening
- Two mesh pockets on the sides
- Additional front compartment with zip fastener
- Two belt loops for comfortable carrying
- Padded handle
- Adjustable inner divider
- Detachable shoulder strap

|       |   |    |  |                 |
|-------|---|----|--|-----------------|
| Black |   |    |  | <b>00185075</b> |
|       | 4 | HT |  |                 |

# Suitcases



Trolley

PHOTO BACKPACK



"Miami" Camera Trolley, 200, black/red

**hama**

|                              |                 |
|------------------------------|-----------------|
| Material                     | Nylon           |
| Outside Dimensions W x D x H | 30 x 23 x 50 cm |
| Weight                       | 2900 g          |

- Padded, removable camera compartment with a lid made of mesh material
- One front compartment with a padded notebook divider
- One additional front compartment each with an organizer and for small accessories
- Tablet compartment made from neoprene material under the lid
- 8 removable inner dividers in the camera compartment, 1 neoprene divider with hook and loop fastener for fixing a camera
- Adjustable length shoulder straps with ergonomic padding integrated in the back of the trolley
- Handle with soft padding
- Two side pockets made of mesh material
- Adjustable tripod holder at the side of the trolley
- Feet
- Trolley frame and wheels
- Suitable as hand luggage
- All-weather cover protects the backpack from rain and dust

|     |  |   |    |          |
|-----|--|---|----|----------|
| 200 |  |   |    | 00139854 |
|     |  | 1 | HT |          |



"Ohio" Camera Trolley, 200, Stable Photo Case for Hand Luggage, black/red

**hama**

|                              |                            |
|------------------------------|----------------------------|
| Material                     | Recycled Polyester (R-PET) |
| Outside Dimensions W x D x H | 30 x 23 x 50 cm            |
| Weight                       | 2900 g                     |

- Main compartment with double zip
- Padded, removable camera compartment with cover closure made from mesh material
- One front compartment with padded notebook divider
- One further front compartment with organiser and pockets for small accessories
- Under the cover is a tablet compartment made from neoprene material
- 8 removable inner dividers in the camera compartment, 1 neoprene divider with hook and loop fastener secures the camera in place
- Length-adjustable backpack strap with ergonomically shaped padding, integrated into the back of the trolley
- Soft, padded carrying handle
- Two side pockets made from mesh material
- Height-adjustable tripod holder on the side of the trolley
- Base
- Trolley frame and wheels
- Suitable as hand luggage
- All-weather cover protects the backpack from rain and dust

|     |  |   |    |          |
|-----|--|---|----|----------|
| 200 |  |   |    | 00121347 |
|     |  | 1 | HT |          |

## Backpack



"Matera" Camera Backpack, 200, black

**hama**

|                              |                            |
|------------------------------|----------------------------|
| Material                     | Recycled Polyester (R-PET) |
| Outside Dimensions W x D x H | 31 x 42 cm                 |
| Volume                       | 22 l                       |
| Weight                       | 900 g                      |

- Quick access to the padded camera compartment via the outside of the backpack
- Compartment that can be filled from the top for personal items, with double zip fastener
- Compartment on the rear with double zip fastener for complete access to the camera gear
- On the inside of the backpack is a compartment for tablets or Notebooks up to 15.6"
- 5 adjustable inner dividers and an elasticated band holder in camera compartment
- Length-adjustable shoulder straps with ergonomically shaped padding
- Padded back
- Adjustable chest strap
- With an additional shoulder strap, the backpack can be converted into a shoulder bag
- Extra carry handle at top and on the side
- 2 compartments with zip fasteners on the front of the backpack
- 1 side pocket (e.g. for water bottle)
- Adjustable loops on the bottom of the backpack for attaching a tripod, etc.
- Suitable as hand luggage
- All-weather cover protects the backpack from rain and dust

|               |          |
|---------------|----------|
| 39 cm (15.4") | 00121341 |
| 2             | HT       |



"Matera" Camera Backpack, 160, black

**hama**

|                              |                            |
|------------------------------|----------------------------|
| Material                     | Recycled Polyester (R-PET) |
| Outside Dimensions W x D x H | 30 x 17.5 x 50 cm          |
| Volume                       | 26 l                       |
| Weight                       | 850 g                      |

- Both the inner and outer material are made from 100% recycled polyester
- Resource-sparing production from recycled PET materials that can be processed into yarn
- Padded, removable camera compartment integrated into bottom section
- Camera compartment opening secured with water-repellent zip fastener
- Compartment that can be filled from the top for personal items etc.
- On the inside of the back is a compartment for tablets or Notebooks up to 15.6"
- 5 removable inner dividers in the camera compartment
- Length-adjustable shoulder straps with ergonomically shaped padding
- Padded back section
- Adjustable chest strap
- Extra carry handle
- 2 side pockets (e.g. for water bottle)
- Adjustable loops for attaching a tripod etc.
- Suitable as hand luggage
- All-weather cover protects the backpack from rain and dust

|               |          |
|---------------|----------|
| 39 cm (15.4") | 00121340 |
| 2             | HT       |



PHOTO BACKPACK

# Backpacks



PHOTO BACKPACK



"Miami" Camera Backpack, 190, black/red

**hama**

|          |           |
|----------|-----------|
| Material | Polyester |
| Volume   | 12 l      |
| Weight   | 950 g     |

- Padded camera compartment
- 8 removable inner dividers in the camera compartment, 1 neoprene divider with hook and loop fastener for fixing a camera
- Adjustable length shoulder straps with ergonomic padding
- Adjustable waist strap
- Handle with soft padding
- Neoprene compartment for tablet PCs up to 10.1" and zippered mesh compartment under the lid
- Additional front compartment with a zippered mesh compartment and an organizer made from neoprene material
- Two side pockets made from mesh material
- Adjustable tripod holder at the side of the backpack
- Suitable for hand luggage
- All-weather cover protects the backpack from rain and dust

|               |                 |
|---------------|-----------------|
| 26 cm (10.2") | <b>00139855</b> |
| 2             | HT              |



"Miami" Camera Backpack, 150, black/red

**hama**

|          |           |
|----------|-----------|
| Material | Polyester |
| Volume   | 5 l       |
| Weight   | 600 g     |

- Padded camera compartment
- 8 removable inner dividers in the camera compartment, 1 neoprene divider with hook and loop fastener for fixing a camera
- Adjustable length shoulder straps with ergonomic padding
- Adjustable waist strap
- Handle with soft padding
- Neoprene compartment for tablet PCs up to 10.1" under the lid
- Additional front compartment with a zippered mesh compartment and an organizer made from neoprene material
- Two side pockets made from mesh material
- Adjustable tripod holder at the side of the backpack
- Suitable for hand luggage
- All-weather cover protects the backpack from rain and dust

|               |                 |
|---------------|-----------------|
| 26 cm (10.2") | <b>00139856</b> |
| 4             | HT              |





PHOTO BACKPACK



"Ohio" Camera Backpack, 190, black/red

**hama**

|                              |                            |
|------------------------------|----------------------------|
| Material                     | Recycled Polyester (R-PET) |
| Outside Dimensions W x D x H | 33 x 20 x 48 cm            |
| Volume                       | 12 l                       |
| Weight                       | 950 g                      |

- Padded camera compartment with double-zipper opening
- 8 removable inner dividers in the camera compartment, 1 Neoprene divider with hook and loop fastener secures the camera in place
- Length-adjustable shoulder straps with ergonomically shaped padding
- Length-adjustable hip strap
- Length-adjustable breast strap
- Soft, padded carrying handle
- Under the cover is a Neoprene compartment for tablet PCs up to 14.6"
- Further front pocket with mesh zip-up compartment and organiser made from Neoprene material
- Two side pockets made from mesh material
- Height-adjustable tripod holder on the side of the backpack
- Suitable as hand luggage
- All-weather cover protects the backpack from rain and dust

|                  |          |
|------------------|----------|
| 32,77 cm (12,9") | 00121346 |
| 2                | HT       |

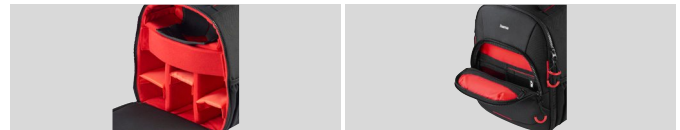

"Ohio" Camera Backpack, 150, black/red

**hama**

|                              |                            |
|------------------------------|----------------------------|
| Material                     | Recycled Polyester (R-PET) |
| Outside Dimensions W x D x H | 26 x 18 x 37 cm            |
| Volume                       | 5 l                        |
| Weight                       | 600 g                      |

- Padded camera compartment with double-zipper opening
- 6 removable inner dividers in the camera compartment, 1 Neoprene divider with hook and loop fastener secures the camera in place
- Length-adjustable shoulder straps with ergonomically shaped padding
- Length-adjustable hip strap
- Length-adjustable breast strap
- Soft, padded carrying handle
- Under the cover is a Neoprene compartment for tablet PCs up to 10.1"
- Further front pocket with mesh zip-up compartment and organiser made from Neoprene material
- Two side pockets made from mesh material
- Height-adjustable tripod holder on the side of the backpack
- Suitable as hand luggage
- All-weather cover protects the backpack from rain and dust

|               |          |
|---------------|----------|
| 27,9 cm (11") | 00121345 |
| 4             | HT       |

# Backpacks



PHOTO BACKPACK



"Profitour" Camera Back Pack, 240, black

**hama**

|          |        |
|----------|--------|
| Material | Nylon  |
| Volume   | 21 l   |
| Weight   | 1950 g |

- Variable internal sectioning thanks to hook and eye connectors allows a mix of photo equipment and personal items
- Lens support ensures a secure grip for the camera
- It is loaded from the back and in the lower section, protecting the contents from theft
- The back pack is divided into two separate photo sections
- Two large side pockets with zip fasteners
- One elastic side pocket
- Padded tablet pocket on the inside of the back
- 1 mesh inner pocket for further accessories
- The internal compartments for full / spent batteries and filters
- Internal compartments for full / empty memory cards directly on the quick access
- 1 zipped compartment under the cover
- 1 zipped compartment on the cover
- Padded, length-adjustable shoulder strap and abdominal belt
- Zipped compartments on the right and left of the abdominal belt
- Soft, padded back section
- Soft handle
- Height-adjustable breast strap with signal piping
- Loop with fastener at the top and stowable small bag at the bottom for secure tripod transport
- Holders on the right and left, with two loops at the bottom for attaching hiking sticks, etc.
- Integrated rain hood
- Suitable as hand luggage

|               |   |    |  |                 |
|---------------|---|----|--|-----------------|
| 26 cm (10.2") |   |    |  | <b>00139842</b> |
|               | 2 | HT |  |                 |



"Profitour" Camera Backpack, 180, black

**hama**

|          |        |
|----------|--------|
| Material | Nylon  |
| Volume   | 15 l   |
| Weight   | 1350 g |

- Inner dividers adjustable by means of hook and loop fasteners, allow accommodation of photographic equipment and personal items
- Lens support provides a secure hold for the camera
- The backpack can be filled from the back, the contents are thus protected from theft
- Two large elastic side pockets
- Padded inner compartment for a tablet PC (on the back)
- 2 mesh compartments (inside) for additional accessories
- Three inner compartments for full/empty batteries and filters
- Inner compartments for full/empty memory cards directly at the quick access opening
- 1 zipped compartment under the lid
- 1 zipped compartment on the lid
- Padded, adjustable shoulder straps and lap belts
- Back with soft padding
- Soft handle
- Adjustable chest strap with signal whistle
- Loop with a fastener at the top and stowable small bag below for safe transportation of a tripod
- Holders on the left and right, two loops for attaching walking sticks and more at the bottom
- Integrated rain cover
- Suitable for hand luggage

|               |   |    |  |                 |
|---------------|---|----|--|-----------------|
| 26 cm (10.2") |   |    |  | <b>00139841</b> |
|               | 2 | HT |  |                 |



"Samara" Camera Backpack, 170, black

**hama**

|          |                |
|----------|----------------|
| Material | Polytex (600D) |
| Volume   | 8 l            |
| Weight   | 390 g          |

- Padded camera compartment with double-zipper opening
- 7 removable inner dividers in the camera compartment
- Length-adjustable shoulder strap
- Handle
- Under the cover is a zipped compartment for further accessories
- Two side pockets made from mesh material
- Tripod holder on the side of the backpack

|  |   |                 |  |
|--|---|-----------------|--|
|  |   | <b>00185088</b> |  |
|  | 3 | HT              |  |



"Terra" Camera Backpack, 140, grey

**hama**

|                              |                            |
|------------------------------|----------------------------|
| Material                     | Recycled Polyester (R-PET) |
| Outside Dimensions W x D x H | 27 x 23 x 42 cm            |
| Volume                       | 13 l                       |
| Weight                       | 750 g                      |

- The "Terra" range is synonymous with sustainable, high-quality products that are good for both you and the environment
- Both the inner and outer material are made from 100% recycled polyester
- Resource-sparing production from recycled PET materials that can be processed into yarn
- Quick access to the padded camera compartment via the outside of the backpack
- Compartment that can be filled from the top for personal items, etc.
- On the inside of the back is a compartment for tablet PCs up to 12.9"
- 1 removable inner divider in the camera compartment
- 1 removable inner divider in the main compartment
- Length-adjustable shoulder straps with ergonomically shaped padding
- Ergonomically padded back section made from mesh material
- Adjustable chest strap
- Special handle on the back at the top
- Additional handle on the side
- On the inside, under the cover, there are two compartments for accessories such as batteries and SD cards
- A zip pocket on the front with internal compartments for cards and pens
- A width-adjustable side pocket for tripods or water bottles
- Adjustable loop for attaching a tripod, etc.
- Suitable as hand luggage
- Trolley strap on the back
- All-weather cover protects the backpack from rain and dust
- Wipeable base

|                  |   |                 |  |
|------------------|---|-----------------|--|
| 32,77 cm (12,9") |   | <b>00121309</b> |  |
|                  | 2 | HT              |  |



# ActionCam-/GoPro Accessories



# Straps and hand straps | Monopods & Tripods



ACTIONCAM-/GOPRO ACCESSORIES

## Carrying Strap



**hama**

### Chest Mount for GoPro

|          |       |
|----------|-------|
| Material | Nylon |
|----------|-------|

- Can be put on quickly, allows easy attachment of the camera and ensures a secure hold in action
- Simply engage the camera on the quick-release fastener
- Allows you to take stunning videos and photos while wearing your camera on your chest, both hands remain free
- Sturdy quick-release fastener
- Elastic stretch material
- With a transport bag for protecting the equipment

|       |          |
|-------|----------|
| Black | 00004358 |
| 6 BK  |          |

## Hand Strap



**hama**

### "2in1" Floaty Grip, black

|          |                  |
|----------|------------------|
| Material | Plastic Material |
|----------|------------------|

- The floaty grip prevents the GoPro action camera or underwater camera from going down in water
- Suitable for GoPro action cameras and underwater cameras with 1/4" screwed connection
- Single hand grip and buoyancy aid in one
- Slip-resistant grip

|       |          |
|-------|----------|
| Black | 00004458 |
| 6 HB  |          |



**hama**

### Floaty Grip for GoPro, yellow

|          |                  |
|----------|------------------|
| Material | Plastic Material |
|----------|------------------|

- The floaty grip prevents the GoPro action camera from going down in water
- Single hand grip and buoyancy aid in one
- Bright yellow signal colour for quickly finding it again
- Adjustable hand strap for securing the camera

|        |          |
|--------|----------|
| Yellow | 00004407 |
| 6 BK   |          |

## Tripod



**hama**

### "Traveller Pro" Tripod for Smartphones, GoPros, Photo Cameras, 105 - Ball

|                           |   |
|---------------------------|---|
| Thread/Connection         | 1/4" (6.4 mm), GoPro, Smartphone holder |
| Leg Segments              | 8 Sections (7x Extendible)              |
| Material                  | Aluminium                               |
| Tripod Head               | Ball Head                               |
| Type                      | Tripod                                  |
| Min. Height - Max. Height | 23 - 105 cm                             |
| Maximum Profile Thickness | 19 mm                                   |
| Weight                    | 455 g                                   |

- Its compact size makes it ideal for travelling, holidays, hikes and outdoor trips
- Sensational, versatile photos and videos from original perspectives and unusual places
- For selfies and videos, perfect for video diaries, blogs and ideal for travel and out and about
- No more wobbly, skewed selfies
- Tripod leg covered with high-quality, durable rubber with a honeycomb pattern for outstanding grip
- Rotary ring on the tripod head allows a wide or narrow spread of the tripod legs depending on the setting
- Extremely flexible, suitable for a smartphone width from 4.8 – 9.5 cm (in horizontal format) thanks to the double extendable clamp spring holder
- Foam padding on the holder protects the smartphone case from scratches
- Patterned rubber feet for firm grip on smooth, slippery and uneven surfaces
- Space-saving design: the smartphone holder can be folded
- Smartphone holder is removable and compatible with other tripods

|      |          |
|------|----------|
| Red  | 00004620 |
| 6 HB |          |



**hama**

### "Traveller Pro" Tripod for Smartphones, GoPros, Photo Cameras, 106 - 2D

|                           |   |
|---------------------------|---|
| Thread/Connection         | 1/4" (6.4 mm), GoPro, Smartphone holder |
| Leg Segments              | 8 Sections (7x Extendible)              |
| Material                  | Aluminium                               |
| Tripod Head               | 2D: 2-Way Head                          |
| Type                      | Tripod                                  |
| Min. Height - Max. Height | 25.5 - 106 cm                           |
| Maximum Profile Thickness | 19 mm                                   |
| Weight                    | 610 g                                   |

- The 2D tilt head allows perfect alignment for landscape shots
- Its compact size makes it ideal for travelling, holidays, hikes and outdoor trips
- Sensational, versatile photos and videos from original perspectives and in unusual locations
- For selfie photos and videos, ideal for video diaries, blogs and for holidays and life on the move
- No more wobbly, skewed selfies
- Tripod leg covered with high-quality, durable rubber with a honeycomb pattern for outstanding grip
- Rotary ring on the tripod head allows a wide or narrow spread of the tripod legs depending on the setting
- Extremely flexible, suitable for a smartphone width from 4.8 – 9.5 cm (in horizontal format) thanks to the double extendable clamp spring holder
- Foam padding on the holder protects the smartphone case from scratches
- Patterned rubber feet for firm grip on smooth, slippery and uneven surfaces
- Space-saving design: the smartphone holder can be folded

|       |          |
|-------|----------|
| Red   | 00004631 |
| 20 HB |          |

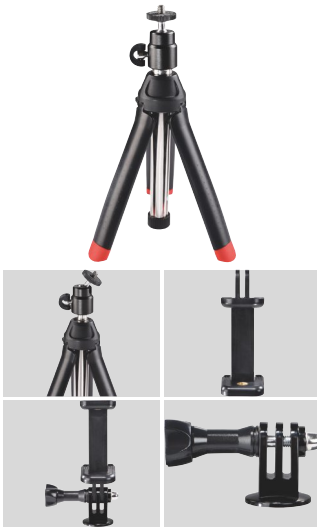

## hama

### "Multi 4in1" Table Tripod

|                           |               |
|---------------------------|---------------|
| Thread/Connection         | 1/4" (6.4 mm) |
| Material                  | Aluminium     |
| Maximum Load              | 400 g         |
| Tripod Head               | 3-Way Head    |
| Type                      | Tripod        |
| Min. Height - Max. Height | 19 -86 cm     |
| Weight                    | 220 g         |

- The ball head allows perfect alignment for shots in portrait and landscape format
- Its compact size makes it ideal for travelling, holidays, hikes and outdoor trips
- The built-in self monopod is ideal for sports and action shots e.g. for filming yourself when skiing Selfie Stick / Telescopic Rod:
- Telescopic rod extendable to 90 cm for a wide range of action, for e.g. concert recordings, hard-to-reach motifs and group shots
- Torsion-resistant telescopic rod through guide groove
- Min/max height: 20/90 cm
- Weight: 225 g

#### Smartphone Holder:

- Extremely flexible, for a smartphone width from 5.5 - 7.8 cm (in horizontal format)
- For selfies and videos, perfect for video diaries, blogs and ideal for travel and out and about
- Also in combination with tripods and telescopic rods with 1/4" connection thread
- No more wobbly, skewed selfies

|       |          |
|-------|----------|
| Black | 00004601 |
| 6     | SC       |

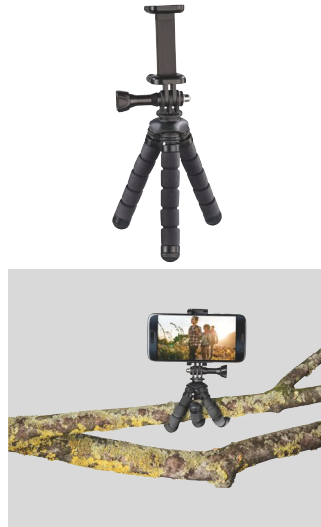

## hama

### Tripod "Flex for Smartphone and GoPro, 14 cm"

|                           |                          |
|---------------------------|--------------------------|
| Thread/Connection         | GoPro, Smartphone holder |
| Leg Segments              | 1 Section                |
| Material                  | Aluminium                |
| Maximum Load              | 4000 g                   |
| Tripod Head               | No                       |
| Type                      | Bendable Tripod          |
| Min. Height - Max. Height | 7 -14 cm                 |
| Maximum Profile Thickness | 26 mm                    |
| Weight                    | 70 g                     |

- The flexible legs are capable of bending up to 360° which allows optimal, secure attachment to various objects, e.g. railings, branches
- 2-in-1 system for smartphones and GoPro cameras
- Its compact size makes it ideal for travelling, holidays, hikes and outdoor trips
- Sensational, versatile photos and videos from original perspectives and unusual places
- Stepless, individually bendable tripod legs — adaptable to many surfaces and objects and can be used as a hand-held tripod
- For selfies and videos, perfect for video diaries, blogs and ideal for travel and out and about
- No more wobbly, skewed selfies
- Tripod legs encased in high quality foam for maximum flexibility and grip, making them especially pleasant to use in cold weather

|       |          |
|-------|----------|
| Blue  | 00004610 |
| Red   | 00004611 |
| Black | 00004609 |
| 6     | HB       |

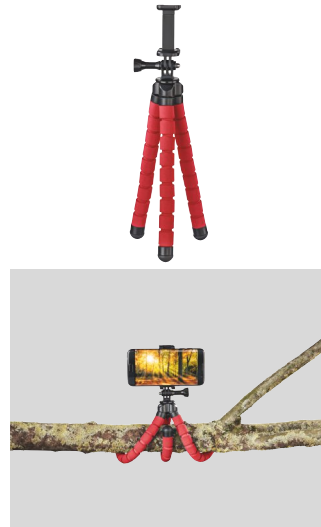

## hama

### Tripod "Flex for Smartphone and GoPro, 26 cm"

|                           |                          |
|---------------------------|--------------------------|
| Thread/Connection         | GoPro, Smartphone holder |
| Leg Segments              | 1 Section                |
| Material                  | Aluminium                |
| Tripod Head               | No                       |
| Type                      | Bendable Tripod          |
| Min. Height - Max. Height | 9 -26 cm                 |
| Weight                    | 145 g                    |

- The flexible legs are capable of bending up to 360° which allows optimal, secure attachment to various objects, e.g. railings, branches
- 2-in-1 system for smartphones and GoPro cameras
- Its compact size makes it ideal for travelling, holidays, hikes and outdoor trips
- Sensational, versatile photos and videos from original perspectives and unusual places
- Stepless, individually bendable tripod legs — adaptable to many surfaces and objects and can be used as a monopod
- For selfies and videos, perfect for video diaries, blogs and ideal for travel and out and about
- No more wobbly, skewed selfies
- Tripod legs encased in high quality foam for maximum flexibility and grip, making them especially pleasant to use in cold weather
- Extremely flexible, suitable for a smartphone width from 5.5 – 7.8 cm (in horizontal format) thanks to the clamp spring holder

|       |          |
|-------|----------|
| Blue  | 00004615 |
| Red   | 00004617 |
| Black | 00004613 |
| 6     | HB       |

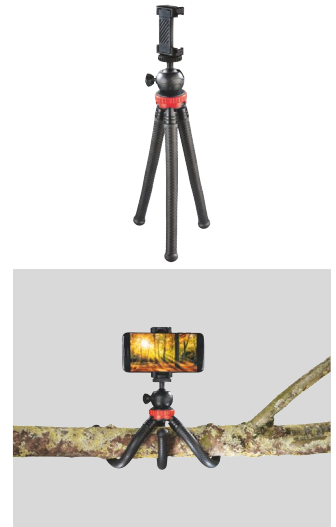

## hama

### Tripod „FlexPro for Smartphone, GoPro and photocopier, 27 cm"

|                           |   |
|---------------------------|---|
| Thread/Connection         | 1/4" (6.4 mm), 3D, Ball, GoPro, Smartphone holder |
| Leg Segments              | 1 Section   |
| Material                  | Aluminium/Rubber                                  |
| Maximum Load              | 300 g   |
| Tripod Head               | Ball Head   |
| Type                      | Bendable Tripod                                   |
| Min. Height - Max. Height | 16 -27 cm   |
| Maximum Profile Thickness | 26 mm   |
| Weight                    | 348 g   |

- The flexible legs are capable of bending up to 360° which allows optimal, secure attachment to various objects, e.g. railings, branches
- 3-in-1 system for smartphones, GoPro cameras and ¼-inch thread
- The ball head allows perfect alignment for shots in portrait and landscape format
- Its compact size makes it ideal for travelling, holidays, hikes and outdoor trips
- Sensational, versatile photos and videos from original perspectives and unusual places
- Stepless, individually bendable tripod legs — adaptable to many surfaces and objects and can be used as a monopod
- For selfies and videos, perfect for video diaries, blogs and ideal for travel and out and about
- No more wobbly, skewed selfies

|       |          |
|-------|----------|
| Red   | 00004608 |
| Blue  | 00004607 |
| Black | 00004605 |
| 6     | HB       |

# Monopods & Tripods



ACTIONCAM-/GOPRO ACCESSORIES



**hama**

"Flex 2in1" Mini-Tripod for Photo Cameras and GoPro, 14 cm

|                           |                      |
|---------------------------|----------------------|
| Thread/Connection         | 1/4" (6.4 mm), GoPro |
| Leg Segments              | 1 Section            |
| Material                  | Aluminium            |
| Maximum Load              | 300 g                |
| Type                      | Bendable Tripod      |
| Min. Height - Max. Height | 7.5 -14 cm           |
| Weight                    | 64 g                 |

- The flexible legs are capable of bending up to 360° which allows optimal, secure attachment to various objects, e.g. railings, branches
- 2in1 system for 1/4 inch threads and GoPro cameras
- Its compact size makes it ideal for travelling, holidays, hikes and outdoor trips
- Non-slip foam on the tripod legs
- Can of course also be used as a normal table tripod

|       |  |   |    |  |  |  |                 |
|-------|--|---|----|--|--|--|-----------------|
| Black |  |   |    |  |  |  | <b>00004557</b> |
|       |  | 6 | HB |  |  |  |                 |



**hama**

"Flex 2in1" Tripod for Photo Cameras and GoPro, 26 cm

|                           |                      |
|---------------------------|----------------------|
| Thread/Connection         | 1/4" (6.4 mm), GoPro |
| Leg Segments              | 1 Section            |
| Material                  | Aluminium            |
| Type                      | Bendable Tripod      |
| Min. Height - Max. Height | 10 -26 cm            |
| Weight                    | 145 g                |

- The flexible legs are capable of bending up to 360° which allows optimal, secure attachment to various objects, e.g. railings, branches
- 2in1 system for 1/4 inch threads and GoPro cameras
- Handy travel format for easy transport in a bag or back pack
- Non-slip foam on the tripod legs
- Can of course also be used as a normal table tripod

|       |  |   |    |  |  |  |                 |
|-------|--|---|----|--|--|--|-----------------|
| Black |  |   |    |  |  |  | <b>00004558</b> |
|       |  | 6 | HB |  |  |  |                 |



**hama**

Suction Mount with Ball Head 360 for GoPro

|              |                  |
|--------------|------------------|
| Material     | Plastic Material |
| Maximum Load | 300 g            |
| Type         | Suction Stand    |
| Weight       | 180 g            |

- The ball head allows perfect alignment for shots in portrait and landscape format
- For GoPro action cameras and digital cameras with a 1/4" connection thread
- 3D ball head with 360° rotation
- Can also be used as a car pod
- Diameter of the suction cup: 90 mm
- Thread length adjustable, therefore universally usable

|       |  |   |    |  |  |  |                 |
|-------|--|---|----|--|--|--|-----------------|
| Black |  |   |    |  |  |  | <b>00004356</b> |
|       |  | 6 | BK |  |  |  |                 |

Selfie Stick



**hama**

"Selfie 90" Self-Monopod

|                |       |
|----------------|-------|
| Maximum Length | 90 cm |
| Minimum Length | 30 cm |

- 2in1 system for 1/4 inch threads and GoPro cameras
- The telescopic pole is extendable up to 90 cm and ideal for situations where additional height is necessary to capture the desired images, e.g. at action recordings, concerts, for difficult-to-capture subjects or group pictures
- Completely new perspectives are possible with this self monopod
- Connection for all cameras with a tripod thread, e.g. action cameras or digital cameras and GoPro connection
- Non-slip foam grip with a hand strap and snap hook for a firm and secure grip
- Can also be used as a tripod extension

|       |  |   |    |  |  |  |                 |
|-------|--|---|----|--|--|--|-----------------|
| Black |  |   |    |  |  |  | <b>00004299</b> |
|       |  | 6 | BK |  |  |  |                 |





**hama**

## "Selfie 50" Self-Monopod

|                |       |
|----------------|-------|
| Maximum Length | 47 cm |
| Minimum Length | 18 cm |

- 2in1 system for 1/4 inch threads and GoPro cameras
- The telescopic pole is extendable up to 47 cm and ideal for situations where additional height is necessary to capture the desired images, e.g. at action recordings, concerts, for difficult-to-capture subjects or group pictures
- Completely new perspectives are possible with this self monopod
- Connection for all cameras with a tripod thread, e.g. action cameras or digital cameras and GoPro connection
- Non-slip foam grip with a hand strap and snap hook for a firm and secure grip
- Can also be used as a tripod extension

|       |  |   |    |                 |
|-------|--|---|----|-----------------|
| Black |  |   |    | <b>00004278</b> |
|       |  | 6 | BK |                 |

### Holder



**hama**

## Head Strap Mount for GoPro

|            |                  |
|------------|------------------|
| Attachment | Strap Attachment |
| Material   | Nylon            |

- Non-slip rubber coating on the inside for a firm hold
- Gives you a near-eye level point of view by securely fitting around your ski and sports helmets, both hands remain free
- The strap can be worn directly on your head or over a helmet
- Fully adjustable to fit different sizes
- Elastic stretch material

|       |  |   |    |                 |
|-------|--|---|----|-----------------|
| Black |  |   |    | <b>00004359</b> |
|       |  | 6 | BK |                 |



**hama**

## "Side" Helmet Mount for GoPro

|            |                   |
|------------|-------------------|
| Attachment | Adhesive Mounting |
| Material   | Plastic Material  |

- 3-way swivelling arm for all imaginable shooting angles
- The high-quality 3M adhesive technology ensures a consistently reliable hold also in the rain and cold
- Gives you a near-eye level point of view by securely fitting around your ski and sports helmets, both hands remain free

|       |  |    |    |                 |
|-------|--|----|----|-----------------|
| Black |  |    |    | <b>00004396</b> |
|       |  | 12 | BK |                 |



**hama**

## "Front" Helmet Mount for GoPro

|            |                   |
|------------|-------------------|
| Attachment | Adhesive Mounting |
| Material   | Plastic Material  |

- The high-quality 3M adhesive technology ensures a consistently reliable hold also in the rain and cold
- Gives you a near-eye level point of view by securely fitting around your ski and sports helmets, both hands remain free
- Allows you to capture forward facing footage by mounting your GoPro action camera on the helmet

|       |  |    |    |                 |
|-------|--|----|----|-----------------|
| Black |  |    |    | <b>00004398</b> |
|       |  | 12 | BK |                 |



**hama**

## Mounting Clamp, 360°, for GoPro

|            |                  |
|------------|------------------|
| Attachment | Clamp for fixing |
| Material   | Plastic Material |

- Allows ultra compact and space-saving attachment
- Can be rotated 360°
- For attaching to jackets, rods, plates, glass and much more
- Small teeth on the inside of the clamp for a firm grip

|       |  |    |    |                 |
|-------|--|----|----|-----------------|
| Black |  |    |    | <b>00004395</b> |
|       |  | 12 | BK |                 |



**hama**

## "Large" Pole Mount for GoPro, from 2.5 - 6.2 cm

|            |                  |
|------------|------------------|
| Attachment | Pole Mount       |
| Material   | Plastic Material |

- 3-way swivelling arm for all imaginable shooting angles
- Extraordinary perspectives on handlebars, rods, ski poles, etc., both hands remain free
- Suitable for rods and tubes from 2.5 to 6.2 cm

|       |  |    |    |                 |
|-------|--|----|----|-----------------|
| Black |  |    |    | <b>00004399</b> |
|       |  | 12 | BK |                 |



**hama**

## "Small" Pole Mount for GoPro, from 1.6 - 4 cm

|            |                  |
|------------|------------------|
| Attachment | Pole Mount       |
| Material   | Plastic Material |

- 3-way swivelling arm for all imaginable shooting angles
- Extraordinary perspectives on handlebars, rods, ski poles, etc., both hands remain free
- Suitable for rods and tubes from 1.6 to 4.0 cm

|       |  |    |    |                 |
|-------|--|----|----|-----------------|
| Black |  |    |    | <b>00004375</b> |
|       |  | 12 | BK |                 |



ACTIONCAM-/GOPRO ACCESSORIES



**hama**

**Diving Goggles for GoPro**

|          |                  |
|----------|------------------|
| Material | Plastic Material |
|----------|------------------|

- Suitable for swimming or snorkelling
- Soft silicone mask for comfortable wearing
- Double sealing lip
- Pull strap for variable adjustment
- Coated safety glass (tempered glass)
- Rust-resistant screw included

|        |          |
|--------|----------|
| Yellow | 00004442 |
|        | 24 HB    |



**hama**

**1/4" Camera Connection Adapter for GoPro Accessories, Version II**

|          |                  |
|----------|------------------|
| Material | Plastic Material |
|----------|------------------|

|       |          |
|-------|----------|
| Black | 00004467 |
|       | 12 BK    |



**hama**

**Camera Adapter for GoPro to 1/4" Tripod Mount**

|          |                  |
|----------|------------------|
| Material | Plastic Material |
|----------|------------------|

|       |          |
|-------|----------|
| Black | 00004354 |
|       | 12 BK    |

Accessories Set



**hama**

**Accessory Set for GoPro**

|                        |    |
|------------------------|----|
| Set Contents in Pieces | 11 |
|------------------------|----|

- 3-way swivelling arm for all imaginable shooting angles
- The high-quality 3M adhesive technology ensures a consistently reliable hold also in the rain and cold
- Set comprising two different adhesive mounts, two different quick-release fasteners, one 3-way swivelling arm and one long replacement screw

Adhesive pads

|  |          |
|--|----------|
|  | 00004397 |
|  | 12 BK    |



**hama**

**Adhesive Mount Set for GoPro**

|                        |   |
|------------------------|---|
| Set Contents in Pieces | 4 |
|------------------------|---|

- The high-quality 3M adhesive technology ensures a consistently reliable hold also in the rain and cold
- 4-part replacement set consisting of two straight (e.g. for car windows) and two curved (e.g. for sports helmets, handlebars) adhesive mounts
- If required the adhesive mounts can be cleanly removed when heat (hair-dryer) is applied

|  |          |
|--|----------|
|  | 00004374 |
|  | 12 BK    |

# Smartphone/Tablet- Photo Accessories



## LED Light

SMARTPHONE/TABLET PHOTO ACCESSORIES



"SpotLight Steady 120 II" LED Ring Light, Ring Light Tripod for Mobile Phone

**hama**

|                |      |
|----------------|------|
| Max. Lumen     | 1020 |
| Number of LEDs | 160  |

- From influencer to video star: the set, comprising an LED ring light and tripod for the ideal height, offers the ideal conditions for every content creator, and is perfect for all online formats, including YouTube, Twitch, Instagram, TikTok and more
- Selfie ring light with mobile phone holder: The flexible clamping jaws hold the smartphone camera perfectly in position on the tripod, so one tripod is enough for both the phone and ring light
- Small when transporting, big effect when filming: the LED ring light with tripod can be set up quick as a flash anywhere, making it perfect for blogs, vlogs, social media and anyone who likes their equipment flexible and practical
- In your best light: the tripod ring light with 160 LEDs creates the ideal lighting for all video and image formats, so there's less post-editing and instead great images and videos from the first take
- From warm white to daylight bright: control the colour temperature in 3 stages (2100/3000/5500 K) using the cabled remote control, for the optimised and even illumination of videos and portraits, for example
- From radiantly bright to pleasantly dimmed: the light intensity can be adjusted in 10 stages
- Sparkling charming eye effect: LED ring light magically creates a light in the eyes through reflections
- Studio smartphone photography: stable tripod made from robust and lightweight aluminium with fully spreadable tripod legs
- Up and away: extendable 3 ways up to 215 cm, ideal for larger scenarios or for being photographed sitting or standing
- Always the perfect recording position: portrait and landscape format thanks to smartphone holder with ball head and flexible swan neck
- Unusual recording angle: the ring light position can be adjusted in all directions thanks to the ball head
- Universal stand for shots in portrait or landscape format, be it selfies, portraits or video, DIY tutorials or Insta-Live

|          |    |
|----------|----|
| 00004659 |    |
| 4        | SC |

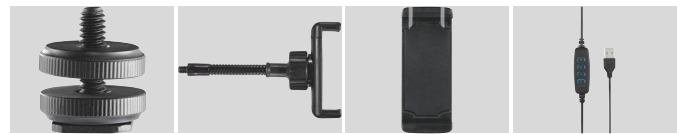

"SpotLight FoldUp 102 II" LED Ring Light, Set for Smartphones, Foldable

**hama**

|                |      |
|----------------|------|
| Max. Lumen     | 1100 |
| Number of LEDs | 128  |

- Sparkling charming eye effect: LED ring light magically creates a light in the eyes through reflections
- From warm white to daylight bright: control the colour temperature in 3 stages using the cabled remote control, for the optimised and even illumination of videos and portraits, for example
- From radiantly bright to pleasantly dimmed: the light intensity can be adjusted in 10 stages
- Photo studio to go: the ring light can be folded together and stored in the stand - perfect for all bloggers and vloggers who are on the go a lot
- Up and away: extendable up to 138 cm, ideal for larger scenarios or for being photographed sitting or standing
- Optimised illumination during make-up tutorials or selfie portraits: can also be used as a table tripod at its minimum height of 52 cm
- Always the perfect recording position: portrait and landscape format thanks to smartphone holder with ball head and flexible swan neck
- One ring light - three ¼" connection options: all connections with ¼" in one place for e.g. swan neck accessories, smartphones, adapter screws
- One right light - four cold shoe connection options: the cold shoe connections are located on all sides for professional and creative photos and videos with further accessories, e.g. microphone, webcam
- LED Ring Light:
  - 10.2" ring light (outer diameter 26.5 cm) with 128 LEDs with cable remote control
  - Power supply via USB-A cable (cable length 190 cm) for connection to e.g. a power pack
  - Unusual recording angle: The ring light can be steplessly tilted backward
  - Easy-carry construction made from aluminium and plastic
- Swan neck with mobile phone holder:
  - For many smartphones: extremely flexible for smartphone widths from 6.0 to 8.0 cm thanks to clamping spring holder
  - Rubber inserts on the holder protect the smartphone casing from scratches

|          |    |
|----------|----|
| 00004658 |    |
| 10       | SC |

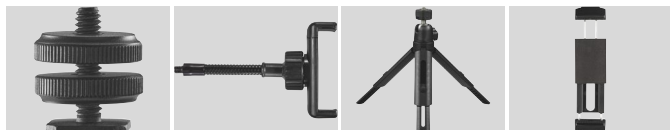

**"SpotLight Smart 80 II" LED Ring Light, Set for Smartphones**



|                |     |
|----------------|-----|
| Max. Lumen     | 950 |
| Number of LEDs | 96  |

- Sparkling charming eye effect: LED ring light magically creates a light in the eyes through reflections
- From warm white to daylight bright: control the colour temperature in 3 stages using the cabled remote control, for the optimised and even illumination of videos and portraits, for example
- From radiantly bright to pleasantly dimmed: the light intensity can be adjusted in 10 stages
- Unusual recording angle: ring light can be pivoted and tilted thanks to the tripod ball head
- Always the perfect recording position: portrait and landscape format thanks to smartphone holder with ball head and flexible swan neck
- One ring light - two 1/4" connection options: the connections are located at the top and bottom for the perfect combination and positioning of equipment such as a webcam and microphone
- One ring light - four cold shoe connection options: the cold shoe connections are located on all sides for professional and creative photos and videos with further accessories,

- e.g. microphone, webcam
- LED Ring Light:
  - 8" ring light (outer diameter 21 cm) with 96 LEDs with cable remote control
  - Power supply via USB-A cable (cable length 190 cm) for connection to e.g. a power pack
- Swan neck with mobile phone holder:
  - For many smartphones: extremely flexible for smartphone widths from 6.0 to 8.0 cm thanks to clamping spring holder
  - Rubber inserts on the holder protect the smartphone casing from scratches
- Ring light with tripod:
  - Height-adjustable desktop tripod from 13.50 cm to 17.50 cm
  - Tripod legs can be adjusted individually in 4 stages in order to adapt the tripod perfectly to different surfaces
  - Rubber feet for firm grip on smooth, slippery and uneven surfaces

|          |    |  |
|----------|----|--|
| 00004657 |    |  |
| 12       | HB |  |



**"49 BD" LED Lights for Smartphone, Photo and Video Cameras**



|                |           |
|----------------|-----------|
| Number of LEDs | 49        |
| Battery Type   | AA Mignon |

- LED Lights
- Ultra-lightweight, stylish surface lights with 49 high-end LEDs for shadow-free image lighting during video and photo shots on a smartphone or camera, as well as close-up and macro-photography
- Optimised illumination ensures even, shadow-free pictures
- For digital video and photo cameras with a standard flash shoe
- Attachment to the camera's standard flash shoe and to a tripod using the integrated 1/4" thread
- With dimmer control
- With integrated 1/4" (6.4 mm) connecting thread for external light positioning on a tripod
- Perfect light source for bloggers and vloggers, ideal for life on the move
- Straightforward operation, no complicated studio equipment required
- For sharp, clear and detail-rich shots
- Great photos even in unfavourable lighting
- No charging required, works with two AA batteries
- Multiple LED lights can also be connected together

- Smartphone Holder:
  - Screw-connected universal holder for devices without tripod socket
  - For attaching all smartphones to tripods with a 1/4" tripod connection
  - Extremely flexible, for a smartphone width from 4.8 - 9.5 cm (landscape format)
  - Cold shoe for attaching LED lights and microphones, for example
  - Folds to a compact size
  - Only in combination with tripods or telescopic rods featuring a 1/4" connection thread, Arca Swiss
  - Clamp spring holder and recess on the surface ensure a firm grip, while rubber protects the housing from scratches

|          |    |  |
|----------|----|--|
| 00004641 |    |  |
| 16       | HB |  |

# Monopods & Tripods

SMARTPHONE/TABLET PHOTO ACCESSORIES

Tripod



**hama**

**Tripod for Smartphone/Tablet, 106 - 3D**

|                           |   |
|---------------------------|---|
| Thread/Connection         | 1/4" (6.4 mm), Smartphone holder, Tablet holder |
| Leg Segments              | 4 Sections (3x Extendible)                      |
| Material                  | Aluminium                                       |
| Maximum Load              | 500 g   |
| Tripod Head               | 3D: 3-Way Head                                  |
| Type                      | Tripod  |
| Min. Height - Max. Height | 36,5 - 106 cm                                   |
| Maximum Profile Thickness | 16.8 mm   |
| Weight                    | 520 g   |

- Camera Tripod:
- Camera tripod for blur-free images and stability on uneven surfaces
- 3D: 3-way head allows perfect orientation for level, horizontal and portrait-format snaps
- Quick-change plate for rapid changing of the camera
- Spirit level integrated into the tripod head
- Infinite height adjustment of the central pillar
- Cross-struts and rubber feet for secure stand
- Functional quick-action leg locks for fast and simple locking of the leg length in any position

Smartphone / Tablet Holder:

- with this holder, all smartphones and tablets can be attached to tripod
- Screw-connected universal holder for devices without tripod socket
- Extremely flexible for a smartphone width from 5.5 to 8.2 cm and a tablet width from 11.2 to 18.5 cm (in horizontal format)

|           |                 |
|-----------|-----------------|
| Champagne | <b>00004619</b> |
| 20        | SC              |



**hama**

**"Star Smartphone" 112 tripod, 3D with "BRS3" Blue-tooth® remote shutter rele**

|                           |                                  |
|---------------------------|----------------------------------|
| Thread/Connection         | 1/4" (6.4 mm), Smartphone holder |
| Leg Segments              | 3 Sections (2x Extendible)       |
| Material                  | Aluminium                        |
| Maximum Load              | 4000 g                           |
| Tripod Head               | 3-Way Head                       |
| Type                      | Tripod                           |
| Min. Height - Max. Height | 40 - 112 cm                      |
| Maximum Profile Thickness | 17 mm                            |
| Weight                    | 480 g                            |

- Camera Tripod
- Camera tripod for blur-free images and stability on uneven surfaces
- 3D: 3-way head allows perfect orientation for horizontal, vertical and portrait-format snaps
- Infinite height adjustment of the central pillar
- Cross-struts and rubber feet for secure stand
- Functional quick-action legs for fast and simple adjustment of the leg length in any position

Smartphone Holder

- Cold shoe for attaching LED lights and microphones, for example
- Extremely flexible, for smartphone width of 5.6 - 8.2 cm
- Compact design
- For selfies and videos, perfect for video diaries, blogs and ideal for out and about
- No more wobbly, skewed selfies

|       |                 |
|-------|-----------------|
| Black | <b>00004640</b> |
| 15    | SC              |



**hama**

**"Traveller Pro" Tripod for Smartphones, GoPros, Photo Cameras, 105 - Ball**

|                           |   |
|---------------------------|---|
| Thread/Connection         | 1/4" (6.4 mm), GoPro, Smartphone holder |
| Leg Segments              | 8 Sections (7x Extendible)              |
| Material                  | Aluminium                               |
| Tripod Head               | Ball Head                               |
| Type                      | Tripod                                  |
| Min. Height - Max. Height | 23 - 105 cm                             |
| Maximum Profile Thickness | 19 mm                                   |
| Weight                    | 455 g                                   |

- Its compact size makes it ideal for travelling, holidays, hikes and outdoor trips
- Sensational, versatile photos and videos from original perspectives and unusual places
- For selfies and videos, perfect for video diaries, blogs and ideal for travel and out and about
- No more wobbly, skewed selfies
- Tripod leg covered with high-quality, durable rubber with a honeycomb pattern for outstanding grip
- Rotary ring on the tripod head allows a wide or narrow spread of the tripod legs depending on the setting
- Extremely flexible, suitable for a smartphone width from 4.8 - 9.5 cm (in horizontal format) thanks to the double extendable clamp spring holder
- Foam padding on the holder protects the smartphone case from scratches
- Patterned rubber feet for firm grip on smooth, slippery and uneven surfaces
- Space-saving design: the smartphone holder can be folded

|     |                 |
|-----|-----------------|
| Red | <b>00004620</b> |
| 6   | HB              |

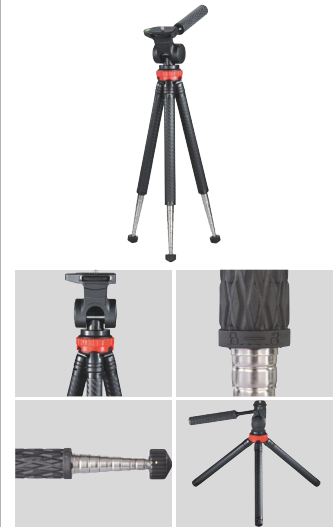

**hama**

**"Traveller Pro" Tripod for Smartphones, GoPros, Photo Cameras, 106 - 2D**

|                           |   |
|---------------------------|---|
| Thread/Connection         | 1/4" (6.4 mm), GoPro, Smartphone holder |
| Leg Segments              | 8 Sections (7x Extendible)              |
| Material                  | Aluminium                               |
| Tripod Head               | 2D: 2-Way Head                          |
| Type                      | Tripod                                  |
| Min. Height - Max. Height | 25.5 - 106 cm                           |
| Maximum Profile Thickness | 19 mm                                   |
| Weight                    | 610 g                                   |

- the 2D tilt head allows perfect alignment for landscape shots
- Its compact size makes it ideal for travelling, holidays, hikes and outdoor trips
- Sensational, versatile photos and videos from original perspectives and in unusual locations
- For selfie photos and videos, ideal for video diaries, blogs and for holidays and life on the move
- No more wobbly, skewed selfies
- Tripod leg covered with high-quality, durable rubber with a honeycomb pattern for outstanding grip
- Rotary ring on the tripod head allows a wide or narrow spread of the tripod legs depending on the setting
- Extremely flexible, suitable for a smartphone width from 4.8 - 9.5 cm (in horizontal format) thanks to the double extendable clamp spring holder
- Foam padding on the holder protects the smartphone case from scratches
- Patterned rubber feet for firm grip on smooth, slippery and uneven surfaces

|     |                 |
|-----|-----------------|
| Red | <b>00004631</b> |
| 20  | HB              |

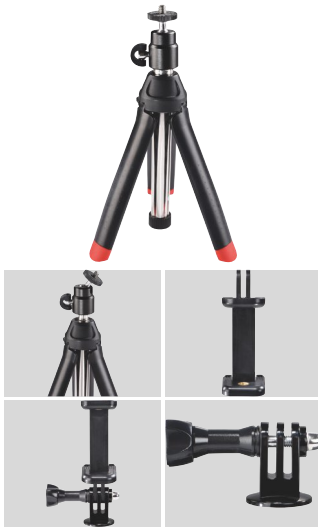

**hama**

## "Multi 4in1" Table Tripod

|                           |               |
|---------------------------|---------------|
| Thread/Connection         | 1/4" (6.4 mm) |
| Material                  | Aluminium     |
| Maximum Load              | 400 g         |
| Tripod Head               | 3-Way Head    |
| Type                      | Tripod        |
| Min. Height - Max. Height | 19 -86 cm     |
| Weight                    | 220 g         |

- The ball head allows perfect alignment for shots in portrait and landscape format
- Its compact size makes it ideal for travelling, holidays, hikes and outdoor trips
- The built-in self monopod is ideal for sports and action shots e.g. for filming yourself when skiing
- Telescopic rod extendable to 90 cm for a wide range of action, for e.g. concert recordings, hard-to-reach motifs and group shots
- Torsion-resistant telescopic rod through guide groove
- Min/max height: 20/90 cm
- Weight: 225 g

### Smartphone Holder:

- Extremely flexible, for a smartphone width from 5.5 - 7.8 cm (in horizontal format)
- For selfies and videos, perfect for video diaries, blogs and ideal for travel and out and about
- Also in combination with tripods and telescopic rods with 1/4" connection thread
- No more wobbly, skewed selfies

|       |   |    |  |                 |
|-------|---|----|--|-----------------|
| Black |   |    |  | <b>00004601</b> |
|       | 6 | SC |  |                 |



**hama**

## "Rotary Smartphone" 150 Tripod, Set with Bluetooth® Remote Shutter Release

|                           |                            |
|---------------------------|----------------------------|
| Thread/Connection         | 1/4" (6.4 mm)              |
| Leg Segments              | 3 Sections (2x Extendible) |
| Material                  | Aluminium                  |
| Maximum Load              | 1000 g                     |
| Tripod Head               | No                         |
| Type                      | Tripod                     |
| Min. Height - Max. Height | 41.5 -150 cm               |
| Maximum Profile Thickness | 20 mm                      |
| Weight                    | 1850 g                     |

- Flexible alternative to large tripods: ideal when things need to move quickly or when there isn't enough space for a large tripod, for example
- Its compact size makes it ideal for travelling, holidays, hikes and outdoor trips
- With the combination of the tripod and holder, take blur-free photographs with the smartphone
- Can be used completely folded up as a selfie monopod
- Stepless height adjustment thanks to telescope mechanism
- Cross-struts and rubber feet for firm grip on smooth, slippery and uneven surfaces
- Swivel smartphone holder for portrait and landscape format
- Extremely flexible, for smartphone width of 5.8 - 8.8 cm
- Compact design
- For selfies and videos, perfect for video diaries, blogs and ideal for out and about

|       |    |    |  |                 |
|-------|----|----|--|-----------------|
| Black |    |    |  | <b>00004646</b> |
|       | 20 | HB |  |                 |



**hama**

## "Solid" Table Tripod for Smartphones and Photo Cameras, 19B

|                           |                                  |
|---------------------------|----------------------------------|
| Thread/Connection         | 1/4" (6.4 mm), Smartphone holder |
| Material                  | Plastic Material                 |
| Tripod Head               | 3D Ball Head                     |
| Type                      | Tripod                           |
| Min. Height - Max. Height | 18 -21 cm                        |
| Weight                    | 270 g                            |

- Stable and robust workmanship with high-quality materials and screwed-in rather than bonded components to guarantee a tripod with a long service life
- The ball head allows perfect alignment for shots in portrait and landscape format
- Its compact size makes it ideal for travelling, holidays, hikes and outdoor trips
- 2in1 system for smartphones, universal 1/4" thread
- Tripod legs can be pulled out in 4 stages: adjustable via moving engagement mechanism at the press of a button on the inside of the tripod legs
- Tripod legs can be adjusted individually in order to adapt the tripod perfectly to different substrates and images
- Extremely flexible, suitable for a smartphone width from 5.9 – 9.0 cm (in horizontal format) thanks to the extendable clamp spring holder
- Double-folding smartphone holder for space-saving and secure transport that protects mechanical parts
- Rubberised padding on the holder and a rubberised protective cap on the thread protect the smartphone casing from scratches

|       |   |    |  |                 |
|-------|---|----|--|-----------------|
| Black |   |    |  | <b>00004630</b> |
|       | 6 | HB |  |                 |

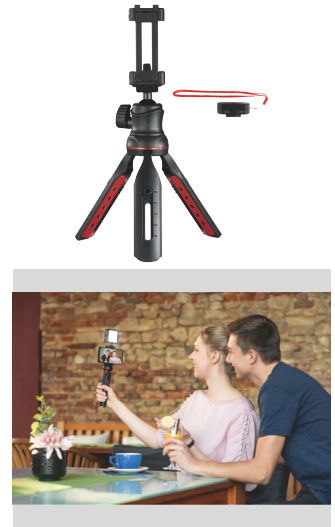

**hama**

## "Solid II, 21B" Table Tripod, with "BRS2" Bluetooth® Remote Trigger

|                           |                                  |
|---------------------------|----------------------------------|
| Thread/Connection         | 1/4" (6.4 mm), Smartphone holder |
| Material                  | Plastic Material                 |
| Tripod Head               | 3D Ball Head                     |
| Type                      | Tripod                           |
| Min. Height - Max. Height | 18 -21 cm                        |
| Weight                    | 270 g                            |

- Stable and robust workmanship with high-quality materials and screwed-in rather than bonded components to guarantee a tripod with a long service life
- The ball head allows perfect alignment for shots in portrait and landscape format
- Its compact size makes it ideal for travelling, holidays, hikes and outdoor trips
- 2in1 system for smartphones, universal 1/4" thread
- Desktop Tripod:
- Tripod legs can be pulled out in 4 stages: adjustable via moving engagement mechanism at the press of a button on the inside of the tripod legs
- Tripod legs can be adjusted individually in order to adapt the tripod perfectly to different surfaces and images
- For a smartphone width from 5.9 – 9.0 cm (in horizontal format) thanks to the extendable clamp spring holder
- Double-folding smartphone holder for space-saving and secure transport that protects mechanical parts
- Rubber finish on the handle and thread protects against scratches
- Cold shoe for attaching LED lights and microphones, for example

|       |    |    |  |                 |
|-------|----|----|--|-----------------|
| Black |    |    |  | <b>00004635</b> |
|       | 10 | HB |  |                 |

# Monopods & Tripods



SMARTPHONE/TABLET PHOTO ACCESSORIES



**hama**

**"Solid III, 80B" Table Tripod for Smartphones, "BRS2" Bluetooth® Remote Tri**

|                           |                                  |
|---------------------------|----------------------------------|
| Thread/Connection         | 1/4" (6.4 mm), Smartphone holder |
| Material                  | Plastic Material                 |
| Tripod Head               | 3D Ball Head                     |
| Type                      | Tripod                           |
| Min. Height - Max. Height | 22 -80 cm                        |
| Weight                    | 345 g                            |

- Stable and robust workmanship with high-quality materials and screwed-in rather than bonded components to guarantee a tripod with a long service life
- The ball head allows perfect alignment for shots in portrait and landscape format
- Its compact size makes it ideal for travelling, holidays, hikes and outdoor trips
- 2in1 system for smartphones, universal 1/4" thread Desktop Tripod:
- Tripod legs can be pulled out in 4 stages: adjustable via moving engagement mechanism at the press of a button on the inside of the tripod legs
- Tripod legs can be adjusted individually in order to adapt the tripod perfectly to different surfaces and images
- For a smartphone width from 5.9 – 9.0 cm (in horizontal format) thanks to the extendable clamp spring holder
- Double-folding smartphone holder for space-saving and secure transport that protects mechanical parts
- Rubber finish on the handle and thread protects against scratches
- Cold shoe for attaching LED lights and microphones, for example

|       |  |  |  |  |   |    |                 |
|-------|--|--|--|--|---|----|-----------------|
| Black |  |  |  |  | 6 | HB | <b>00004653</b> |
|-------|--|--|--|--|---|----|-----------------|

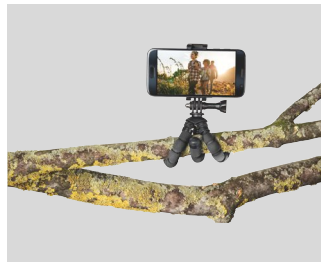

**hama**

**Tripod "Flex for Smartphone and GoPro, 14 cm"**

|                           |                          |
|---------------------------|--------------------------|
| Thread/Connection         | GoPro, Smartphone holder |
| Leg Segments              | 1 Section                |
| Material                  | Aluminium                |
| Maximum Load              | 4000 g                   |
| Tripod Head               | No                       |
| Type                      | Bendable Tripod          |
| Min. Height - Max. Height | 7 -14 cm                 |
| Maximum Profile Thickness | 26 mm                    |
| Weight                    | 70 g                     |

- The flexible legs are capable of bending up to 360° which allows optimal, secure attachment to various objects, e.g. railings, branches
- 2-in-1 system for smartphones and GoPro cameras
- Its compact size makes it ideal for travelling, holidays, hikes and outdoor trips
- Sensational, versatile photos and videos from original perspectives and unusual places
- Stepless, individually bendable tripod legs — adaptable to many surfaces and objects and can be used as a hand-held tripod
- For selfies and videos, perfect for video diaries, blogs and ideal for travel and out and about
- No more wobbly, skewed selfies
- Tripod legs encased in high quality foam for maximum flexibility and grip, making them especially pleasant to use in cold weather

|       |  |  |  |  |   |    |                 |
|-------|--|--|--|--|---|----|-----------------|
| Black |  |  |  |  | 6 | HB | <b>00004609</b> |
|-------|--|--|--|--|---|----|-----------------|

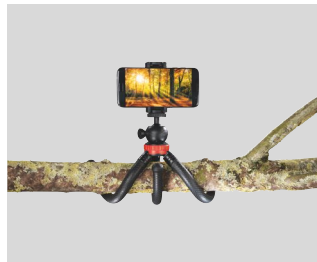

**hama**

**Tripod „FlexPro for Smartphone, GoPro and photocal cameras, 27 cm"**

|                           |   |
|---------------------------|---|
| Thread/Connection         | 1/4" (6.4 mm), 3D, Ball, GoPro, Smartphone holder |
| Leg Segments              | 1 Section   |
| Material                  | Aluminium/Rubber                                  |
| Maximum Load              | 300 g   |
| Tripod Head               | Ball Head   |
| Type                      | Bendable Tripod                                   |
| Min. Height - Max. Height | 16 -27 cm   |
| Maximum Profile Thickness | 26 mm   |
| Weight                    | 348 g   |

- The flexible legs are capable of bending up to 360° which allows optimal, secure attachment to various objects, e.g. railings, branches
- 3-in-1 system for smartphones, GoPro cameras and 1/4-inch thread
- The ball head allows perfect alignment for shots in portrait and landscape format
- Its compact size makes it ideal for travelling, holidays, hikes and outdoor trips
- Sensational, versatile photos and videos from original perspectives and unusual places
- Stepless, individually bendable tripod legs — adaptable to many surfaces and objects and can be used as a monopod
- For selfies and videos, perfect for video diaries, blogs and ideal for travel and out and about
- No more wobbly, skewed selfies

|       |  |  |  |  |  |  |                 |
|-------|--|--|--|--|--|--|-----------------|
| Red   |  |  |  |  |  |  | <b>00004608</b> |
| Black |  |  |  |  |  |  | <b>00004605</b> |

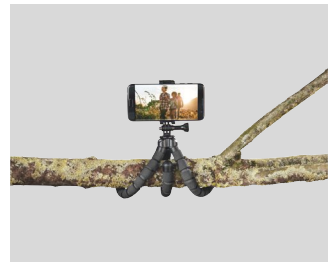

**hama**

**Tripod "Flex for Smartphone and GoPro, 26 cm"**

|                           |                          |
|---------------------------|--------------------------|
| Thread/Connection         | GoPro, Smartphone holder |
| Leg Segments              | 1 Section                |
| Material                  | Plastic Material         |
| Tripod Head               | No                       |
| Type                      | Bendable Tripod          |
| Min. Height - Max. Height | 9 -26 cm                 |

- The flexible legs are capable of bending up to 360° which allows optimal, secure attachment to various objects, e.g. railings, branches
- 2-in-1 system for smartphones and GoPro cameras
- Its compact size makes it ideal for travelling, holidays, hikes and outdoor trips
- Sensational, versatile photos and videos from original perspectives and unusual places
- Stepless, individually bendable tripod legs — adaptable to many surfaces and objects and can be used as a monopod
- For selfies and videos, perfect for video diaries, blogs and ideal for travel and out and about
- No more wobbly, skewed selfies
- Tripod legs encased in high quality foam for maximum flexibility and grip, making them especially pleasant to use in cold weather
- Extremely flexible, suitable for a smartphone width from 5.5 – 7.8 cm (in horizontal format) thanks to the clamp spring holder
- Rubber inserts on the holder protect the smartphone case from scratches
- Rubber feet for firm grip on smooth and slippery surfaces

|       |  |  |  |  |   |    |                 |
|-------|--|--|--|--|---|----|-----------------|
| Black |  |  |  |  | 6 | HB | <b>00004613</b> |
|-------|--|--|--|--|---|----|-----------------|





## hama

### "Pocket II Rotation" Smartphone Mini-Tripod

|                           |                                  |
|---------------------------|----------------------------------|
| Thread/Connection         | 1/4" (6.4 mm), Smartphone holder |
| Leg Segments              | 1 Section                        |
| Material                  | Plastic Material                 |
| Maximum Load              | 300 g                            |
| Tripod Head               | No                               |
| Type                      | Mini Tripod                      |
| Min. Height - Max. Height | 6,5 cm                           |
| Weight                    | 80 g                             |

- Compact, handy and space-saving
- For selfies and videos, perfect for video diaries, blogs and ideal for travel and out and about
- Mini-tripod with 1/4" connection
- Detachable smartphone holder with 1/4" connection
- Swivel smartphone holder for portrait and landscape format
- Extremely flexible for smartphone widths of between 5.8 and 8.5 cm (in horizontal format) thanks to clamping spring holder
- Rubber inserts on the holder protect the smartphone casing from scratches
- Can also be used as a manual tripod
- Rubberised tripod legs for secure grip
- Can also be used as a stand for the smartphone, e.g. on a desk or bedside table
- Cold shoe for attaching LED lights and microphones, for example

|            |          |
|------------|----------|
| Black, Red | 00004649 |
| 16         | HB       |



## hama

### "Pocket" Smartphone Mini-Tripod, 20 cm, black

|                           |                   |
|---------------------------|-------------------|
| Thread/Connection         | Smartphone holder |
| Leg Segments              | 1 Section         |
| Material                  | Plastic Material  |
| Tripod Head               | No                |
| Type                      | Mini Tripod       |
| Min. Height - Max. Height | 10 -20 cm         |
| Weight                    | 87 g              |

- Integrated mirror for the perfect selfie angle with the front camera
- The built-in self monopod is ideal for sports and action shots e.g. for filming yourself when skiing
- Compact, handy and space-saving: fits in any pocket because the smartphone holder can be folded

#### Selfie Stick / Telescopic Rod:

- Telescopic rod extendable to 20 cm for a wide range of action, for e.g. concert recordings, hard-to-reach motifs and group shots
- Torsion-resistant telescopic rod through guide groove
- For selfies and videos, perfect for video diaries, blogs and ideal for travel and out and about
- No more wobbly, skewed selfies
- Extremely flexible, suitable for a smartphone width from 5.0 – 8.5 cm (in horizontal format) thanks to the clamp spring holder
- Rubber inserts on the holder protect the smartphone case from scratches
- Stepless, individually adjustable tripod legs — adaptable to many surfaces and can be used as a hand-held tripod
- Rubberised tripod legs for secure grip

|       |          |
|-------|----------|
| Black | 00004621 |
| 6     | HB       |

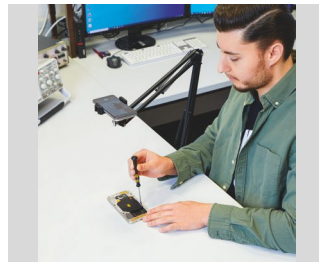

## hama

### "700 II" Flexible Articulated Arm, 1/4", max. 70 cm, Smartphone Holder, Table Clamp

|                           |                                  |
|---------------------------|----------------------------------|
| Thread/Connection         | 1/4" (6.4 mm), Smartphone holder |
| Leg Segments              | 2 Sections (1x Extendible)       |
| Material                  | Metal                            |
| Tripod Head               | No                               |
| Type                      | Light Stand                      |
| Min. Height - Max. Height | 70 cm                            |
| Weight                    | 468 g                            |

- Adjustable screw clamp for various attachment options: all types of desks, workstations, shelves, bars
- No adapter needed: flexible mobile phone holder for attachment to the articulated arm enclosed, for extraordinary shooting angles and perfects shots for every format
- Vertical and horizontal: ring light, camera, webcam, smartphone or tablet - all of them can be precisely positioned wherever you need them thanks to the two highly flexible joints
- Practical, full-motion holder, ideal for office, kitchen, hobby workshop, influencer/vlogger/blogger/YouTube studio or bedside table
- Maximum length 70 cm
- Allows quick and easy access to the device
- Ideal for taking photographs and making videos, for browsing, watching films or for video chats, but also perfectly suited for use in the office
- Comfortable use: the hands are always free and yet each device is in view or quickly adjusted for another scenario or to prevent it getting in the way

|       |          |
|-------|----------|
| Black | 00004660 |
| 24    | HB       |

#### Selfie Stick



## hama

### "Fancy Stand 170" Selfie Stick Tripod for Mobile Phone, Bluetooth® Remote Trigger, blk

|                      |        |
|----------------------|--------|
| Clamping Range From  | 6.2 cm |
| Clamping Range Up To | 9.5 cm |
| Maximum Length       | 170 cm |
| Minimum Length       | 38 cm  |

- Its compact size makes it ideal for travelling, holidays, hikes and outdoor trips

#### Selfie Monopod / Selfie Stick:

- For selfie photos and videos, blogs, ideal for trips and for life on the move
- This selfie monopod opens up completely new perspectives
- Perfect selfie stick for streaming, gaming, cooking and DIY hobbies
- Telescopic bar extendable up to 170 cm for a wider view, e.g. for selfies and group selfies, concerts
- Twist-proof telescopic rod through guide groove
- With smartphone quick clamp for quick attachment to the smartphone
- Swivel smartphone holder for portrait and landscape format
- Extremely flexible, for a smartphone width from 6.5 - 9.5 cm (landscape format)
- Clamp spring holder ensures firm grip, while ribbed rubber pads on the resting surfaces protect the smartphone

#### Bluetooth release:

- Removable Bluetooth trigger for smartphone and tablet cameras
- Connection via Bluetooth directly with the smartphone, no additional app
- Allows unusual photo and selfie angles

|       |          |
|-------|----------|
| Black | 00004662 |
| 6     | HB       |

# Monopods & Tripods | Tripod Accessories



SMARTPHONE/TABLET PHOTO ACCESSORIES

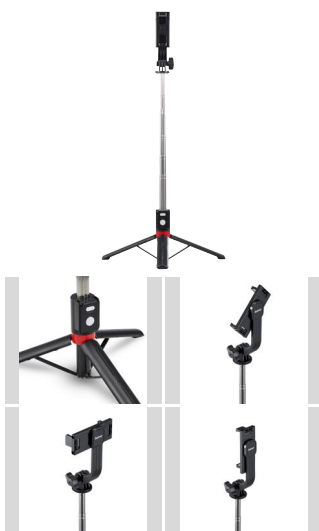

**hama**

## "Fancy Stand 110" Selfie Stick Tripod for Mobile Phone, Bluetooth® Remote Trigger, blk

|                      |        |
|----------------------|--------|
| Clamping Range From  | 6.2 cm |
| Clamping Range Up To | 9 cm   |
| Maximum Length       | 110 cm |
| Minimum Length       | 31 cm  |

- Its compact size makes it ideal for travelling, holidays, hikes and outdoor trips
- Selfie Monopod / Selfie Stick:
- For selfie photos and videos, blogs, ideal for trips and for on the go
- Completely new perspectives are possible with this selfie monopod
- Perfect selfie stick for streaming, gaming, cooking and DIY hobbies
- Telescopic bar extendable up to 110 cm for a wider field of action, e.g. on selfie or group shots, concerts
- Rotation-proof telescopic bar thanks to guide groove
- With smartphone quick clamp for quick smartphone attachment
- Rotating smartphone holder for portrait and landscape format
- Extremely flexible for a smartphone width from 6.5 to 9.5 cm (landscape format)
- Clamp spring holder ensures a firm grip, with rippled rubber pads on the resting surface to protect the smartphone

- Bluetooth trigger:
- Removable Bluetooth trigger for smartphone and tablet cameras
  - Connection via Bluetooth directly with the smartphone, no additional app
  - Allows unusual photo and selfie perspectives

|       |  |   |    |  |  |  |  |  |                 |
|-------|--|---|----|--|--|--|--|--|-----------------|
| Black |  |   |    |  |  |  |  |  | <b>00004661</b> |
|       |  | 6 | HB |  |  |  |  |  |                 |

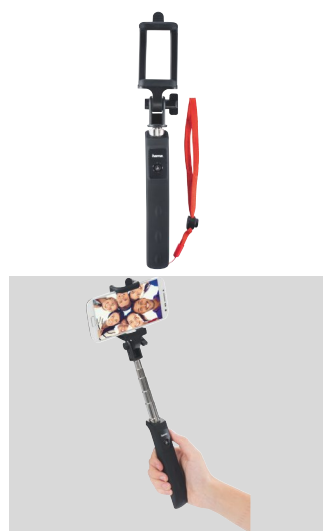

**hama**

## "Fun 70" Selfie, Bluetooth®, black

|                      |         |
|----------------------|---------|
| Clamping Range From  | 5.5 cm  |
| Clamping Range Up To | 8.5 cm  |
| Maximum Length       | 70 cm   |
| Minimum Length       | 20.5 cm |

- Telescopic bar extendable up to 70 cm for a wider view, e.g. for selfies and group selfies, concerts
- Twist-proof telescopic rod through guide groove
- Connection via Bluetooth directly with the smartphone, no additional app required
- Allows unusual photo and selfie angles
- For selfie photos and videos, blogs, ideal for trips, for life on the move and for action photography
- Better focusing, faster snapshots, resulting in better pictures and sharp, un-blurred selfies
- This selfie monopod opens up completely new perspectives
- With smartphone quick clamp for quick attachment to the smartphone
- Non-slip rubber grip for firm, secure grip
- Extremely flexible, for a smartphone width from 5.5 - 8.5 cm (in horizontal format)
- Compact design
- Clamp spring holder ensures firm grip
- Independent of self-trigger mode
- USB connection: micro USB 2.0

|       |  |   |    |  |  |  |  |  |                 |
|-------|--|---|----|--|--|--|--|--|-----------------|
| Black |  |   |    |  |  |  |  |  | <b>00004315</b> |
|       |  | 6 | HB |  |  |  |  |  |                 |

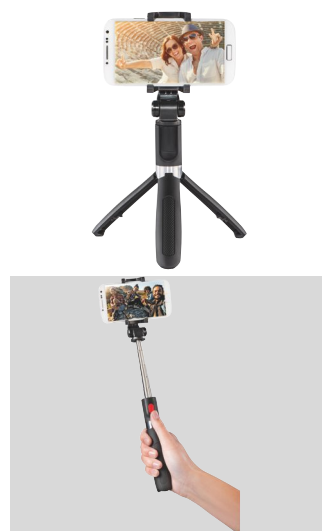

**hama**

## "Funstand 57" Selfie Stick, with Bluetooth® Remote Shutter, black

|                      |        |
|----------------------|--------|
| Clamping Range From  | 6 cm   |
| Clamping Range Up To | 8.5 cm |
| Maximum Length       | 57 cm  |
| Minimum Length       | 16 cm  |

- Its compact size makes it ideal for travelling, holidays, hikes and outdoor trips
- Selfie Monopod / Selfie Stick:
- Ideal for sport and action shots, e.g. filming yourself skiing
- For selfie photos and videos, blogs, ideal for trips and for life on the move
- This selfie monopod opens up completely new perspectives
- Perfect arm extension for wobble-free selfies
- Telescopic bar extendable up to 57 cm for a wider view, e.g. for selfies and group selfies, concerts
- Twist-proof telescopic rod through guide groove
- With smartphone quick clamp for quick attachment to the smartphone
- Swivel smartphone holder for portrait and landscape format
- Non-slip rubber grip for firm, secure grip
- Extremely flexible, for a smartphone width from 6.0 - 8.5 cm (landscape format)
- Clamp spring holder ensures firm grip, while ribbed rubber pads on the resting surfaces protect the smartphone
- Compact design
- Min/max length: 16/57cm

- Bluetooth release:
- Removable Bluetooth trigger for smartphone and tablet cameras

|       |  |   |    |  |  |  |  |  |                 |
|-------|--|---|----|--|--|--|--|--|-----------------|
| Black |  |   |    |  |  |  |  |  | <b>00004316</b> |
|       |  | 6 | HB |  |  |  |  |  |                 |

Ball Joint/Tilt Head



**hama**

## "Twin Ball 72" Joint

|                   |               |
|-------------------|---------------|
| Thread/Connection | 1/4" (6.4 mm) |
| Weight            | 35 g          |

- Ideal attachment arm for vlogger cameras and webcams with 1/4" connection to ring lights with 1/4" connection
- 2 ball joints for customised orientation and fixation of the accessories
- Can be used universally with two 1/4" threads
- Stable metal construction
- Total length 72 mm

|       |  |   |    |  |  |  |  |  |                 |
|-------|--|---|----|--|--|--|--|--|-----------------|
| Black |  |   |    |  |  |  |  |  | <b>00004650</b> |
|       |  | 6 | HB |  |  |  |  |  |                 |

Clamp / Tension Bracket



**hama**

**Clamp / Tension Bracket  
"For Smartphones"**

|            |                            |
|------------|----------------------------|
| Attachment | Tripod Thread 1/4"         |
| Material   | Plastic Material           |
| Model      | Tripod-Mobile Phone-Holder |

- 3 additional threaded connections of 1/4" for professional videos for connection to tripods and 2 additional accessory shoes for further accessories such as LED lights and microphone
- A must-have for anyone who wants to record perfect videos and pictures without "wobble" on their smartphone

|       |                 |    |  |
|-------|-----------------|----|--|
| Black | <b>00004622</b> |    |  |
|       | 18              | HB |  |



**hama**

**"Puck" Tripod Mobile Phone Holder, Magnetic, Universal**

|            |                            |
|------------|----------------------------|
| Attachment | Magnet                     |
| Material   | Metal                      |
| Model      | Tripod-Mobile Phone-Holder |

- Firm grip: the magnetic mobile phone holder keeps the smartphone securely on the magnetic ring and firmly in place without any additional attachments

|  |                 |    |  |
|--|-----------------|----|--|
|  | <b>00004655</b> |    |  |
|  | 6               | HB |  |



**hama**

**"Pro II" Smartphone Holder, 9.5 cm, with "BRS2" Bluetooth® Remote Trigger**

|            |                            |
|------------|----------------------------|
| Attachment | Tripod Thread 1/4"         |
| Material   | Aluminium                  |
| Model      | Tripod-Mobile Phone-Holder |

- Smartphone Holder:
- Screw-connected universal holder for devices without tripod socket
- For attaching smartphones to tripods with a 1/4" tripod connection
- Extremely flexible, for a smartphone width from 4.8 - 9.5 cm (landscape format)
- No more wobbly, skewed selfies

|       |                 |    |  |
|-------|-----------------|----|--|
| Black | <b>00004633</b> |    |  |
|       | 12              | HB |  |



**hama**

**2in1 Smartphone / Tablet Holder, 1/4"**

|          |                  |
|----------|------------------|
| Material | Plastic Material |
|----------|------------------|

- Screw-connected universal holder for devices without tripod socket
- Extremely flexible for a smartphone width from 5.5 to 8.2 cm and a tablet width from 11.2 to 18.5 cm (in horizontal format)
- Compact design
- For selfie photos and videos, ideal for video diaries, blogs and for holidays and life on the move

|       |                 |    |  |
|-------|-----------------|----|--|
| Black | <b>00004638</b> |    |  |
|       | 6               | HB |  |



**hama**

**"Pro" 2in1 Smartphone / Tablet Holder, 1/4"**

|            |                            |
|------------|----------------------------|
| Attachment | Tripod Thread 1/4"         |
| Model      | Tripod-Mobile Phone-Holder |

- Screw-connected universal holder for devices without tripod socket
- Compact design with red toggle switch to increase the size from 6.5 to 17.5 cm
- Cold shoe for attaching LED lights and microphones, for example
- Clamp spring holder and recess on the surface ensure a firm grip, while rubber protects the housing from scratches

|  |                 |    |  |
|--|-----------------|----|--|
|  | <b>00004645</b> |    |  |
|  | 16              | HB |  |



**hama**

**"Bottle Pod Fun" Mobile Phone Holder for Bottles, for Smartphones 5.8 - 8.5**

|            |                    |
|------------|--------------------|
| Attachment | Tripod Thread 1/4" |
| Material   | Silicone           |

- When the bottles empty, the fun really begins: the perfect gadget for spontaneous pictures at birthday, bbq parties and après-ski
- For all common drinks bottles
- Tripod attachment with smartphone holder in a compact pocket format, can travel to any party in a pocket
- Perfect grip in the bottle thanks to tapered silicone cone

|  |                 |    |  |
|--|-----------------|----|--|
|  | <b>00004654</b> |    |  |
|  | 16              | HB |  |



**hama**

**"Pro II" Smartphone Holder, 9.5 cm, 1/4"**

|          |                            |
|----------|----------------------------|
| Material | Plastic Material           |
| Model    | Tripod-Mobile Phone-Holder |

- Screw-connected universal holder for devices without tripod socket
- Extremely flexible, for a smartphone width from 4.8 - 9.5 cm (landscape format)
- No more wobbly, skewed selfies
- For selfies and videos, perfect for video diaries, blogs and ideal for travel and out and about
- Cold shoe for attaching LED lights and microphones, for example

|       |                 |    |  |
|-------|-----------------|----|--|
| Black | <b>00004648</b> |    |  |
|       | 24              | HB |  |



**hama**

**Smartphone Holder, 8.2 cm, 1/4"**

|            |                            |
|------------|----------------------------|
| Attachment | Tripod Thread 1/4"         |
| Material   | Plastic Material           |
| Model      | Tripod-Mobile Phone-Holder |

- Screw-connected universal holder for devices without tripod socket
- Extremely flexible, for a smartphone width from 5.5 - 8.2 cm (in horizontal format)
- Compact design
- For selfie photos and videos, ideal for video diaries, blogs and for holidays and life on the move

|       |                 |    |  |
|-------|-----------------|----|--|
| Black | <b>00004637</b> |    |  |
|       | 24              | HB |  |

## Monitor Arm



**hama**

### Monitor Holder for Streaming Setup, 4 Arms, Height-adjustable, Swivel

|                   |       |
|-------------------|-------|
| Max. Monitor Size | 81 cm |
|-------------------|-------|

- Perfect for the next streaming or gaming session: whether webcam, microphone, smartphone or tablet, ring light or camera, monitor or laptop, there is room for a lot of streaming equipment on the four arms, making it ideal for bloggers, streamers, gamers and so on
- For an ergonomic workstation: the streaming arm adapts to your personal requirements and posture. Whether you need stepless height adjustability, swivel and tilt functions, pull-out capability or portrait or landscape formats, this is how ergonomics works in the office and home office while gaming
- Space for two monitors: the monitor arms be used for all common screen sizes with a diagonal of 33 - 81 cm (13 - 32") and up to a weight of 8 kg per arm
- Unusual recording angle: Streaming light or camera can be rotated and tilted thanks to tripod ball head - for the perfect streaming setup
- Always the perfect recording position: Portrait and landscape format thanks to swivelling smartphone and tablet holder
- For tidy workstations: Cable management guides the monitor cable tidily behind the screen, avoiding cable spaghetti and saving space. The cable guide also protects the cable against breakage thanks to strain relief

|       |   |    |  |                 |
|-------|---|----|--|-----------------|
| Black |   |    |  | <b>00004663</b> |
|       | 1 | SC |  |                 |

## Wireless Shutter Release



**hama**

### "BR53" Bluetooth® remote shutter release

|                   |     |
|-------------------|-----|
| Bluetooth Version | 4.0 |
|-------------------|-----|

- Connection via Bluetooth directly with the smartphone or tablet
- Allows unusual photo and selfie angles
- For selfie photos and videos, blogs, ideal for trips, for life on the move and for action photography
- Better focusing, faster snapshots, resulting in better pictures and sharp, un-blurred selfies
- If the smartphone or tablet is positioned in a suitable spot, both arms can remain free - the extended selfie arm is passé
- Safe photography in high-action situations
- Perfect for party and group shots because the range of up to 10 m allows a much wider image field
- Independent of self-trigger mode
- Small and compact, the Bluetooth shutter release can go anywhere

|       |    |    |  |                 |
|-------|----|----|--|-----------------|
| Black |    |    |  | <b>00004639</b> |
|       | 24 | HB |  |                 |

## USB Lights



**hama**

### "To Go" Streaming Light, 7 LEDs, 3 Light Colours, Touch Sensor and Clip

|                |                |
|----------------|----------------|
| Number of LEDs | 7              |
| Power Supply   | USB Connection |

- Flexible goose neck for optimum positioning
- Integrated touch sensor for switching on / off and changing the colour temperature on 3 levels by touch
- Clip for secure attachment of the LED light, for example to the laptop display
- Laptop light with the advantages of a ring light

|       |   |    |  |                 |
|-------|---|----|--|-----------------|
| Black |   |    |  | <b>00054121</b> |
|       | 6 | HB |  |                 |

## Microphone



**hama**

### "RMN Uni" Directional Microphone, for Accessory Shoe

|              |                  |
|--------------|------------------|
| Connection   | 3.5 mm Jack Plug |
| Directivity  | Uni-directional  |
| Model        | Mono             |
| Cable Length | 0.32 m           |

- From smartphones to camcorders - for bloggers or film-makers: the microphone is ideal for all devices
- The vibration-attenuating anti-shock frame absorbs mechanical vibration and noise
- Passive, dynamic directional microphone

|       |    |    |  |                 |
|-------|----|----|--|-----------------|
| Black |    |    |  | <b>00004647</b> |
|       | 10 | HB |  |                 |



**hama**

### "Smart" Lavalier Microphone

|              |                  |
|--------------|------------------|
| Connection   | 3.5 mm Jack Plug |
| Directivity  | omni-directional |
| Model        | Mono             |
| Cable Length | 6 m              |

- From smartphones to camcorders - for bloggers or film-makers: the microphone is ideal for all devices
- 6 metres for plenty of room to manoeuvre: reporters, vloggers and influencers therefore have plenty of freedom for their voice and video recordings

|       |   |    |  |                 |
|-------|---|----|--|-----------------|
| Black |   |    |  | <b>00004634</b> |
|       | 6 | HB |  |                 |

# Tripods & Accessories



# Monopods & Tripods

## Tripod



**hama**

"Profil Duo" Tripod, 150 - 3D

|                           |                            |
|---------------------------|----------------------------|
| Thread/Connection         | 1/4" (6.4 mm)              |
| Leg Segments              | 3 Sections (2x Extendible) |
| Material                  | Aluminium                  |
| Maximum Load              | 5000 g                     |
| Tripod Head               | 3D: 3-Way Head             |
| Type                      | Tripod                     |
| Min. Height - Max. Height | 53 -150 cm                 |
| Maximum Profile Thickness | 22 mm                      |
| Weight                    | 1480 g                     |

- The 3D tilt head allows perfect alignment for landscape and portrait shots
- Quick-release plate for quickly changing the camera
- The central column can be removed to be used as a fully functioning monopod
- Large, functional quick-action leg locks for fast and simple locking of the leg length in any position
- Spirit level integrated into the tripod head and base
- With rubber feet for secure stand
- Non-slip foam handles on the stand legs for use in all weathers
- Monopod, min. height 45 cm/max. height 162 cm
- Replacement coupling plate Item no. 00004471

|       |   |    |  |                 |
|-------|---|----|--|-----------------|
| Black |   |    |  | <b>00004481</b> |
|       | 6 | SC |  |                 |



**hama**

"TAR Duo" Tripod, 165 - Ball

|                           |                                |
|---------------------------|--------------------------------|
| Thread/Connection         | 1/4" (6.4 mm)                  |
| Leg Segments              | 4 Sections (3x Extendible)     |
| Material                  | Aluminium                      |
| Maximum Load              | 8000 g                         |
| Tripod Head               | 3D Ball Head with Pan function |
| Type                      | Tripod                         |
| Min. Height - Max. Height | 50 -165 cm                     |
| Maximum Profile Thickness | 26 mm                          |
| Weight                    | 1600 g                         |

- Ball head with panorama function allows perfect orientation for recording in portrait and landscape
- Quick-release plate for quickly changing the camera
- Inverted position allows macrophotographs near the ground
- In combination with a leg segment the removable central column can be used as a fully functioning monopod
- Lightweight and sturdy aluminium construction
- Functional quick-action leg locks for fast and simple locking of the leg length in any position
- With rubber feet for secure stand
- Compact pack size of 45 cm thanks to foldable tripod legs
- Spirit level integrated into the tripod head
- Quick-change plate with rubber lining
- Telescoping central pillar with weight hooks for improved stability during windy conditions and on rough terrain
- Tripod legs can be spread apart in increments (3 increments)
- Non-slip foam grip on the tripod legs for use in all weathers

|       |   |    |  |                 |
|-------|---|----|--|-----------------|
| Black |   |    |  | <b>00004475</b> |
|       | 6 | SC |  |                 |



**hama**

"Star 5" Tripod

|                           |                            |
|---------------------------|----------------------------|
| Thread/Connection         | 1/4" (6.4 mm)              |
| Leg Segments              | 4 Sections (3x Extendible) |
| Material                  | Aluminium                  |
| Maximum Load              | 500 g                      |
| Tripod Head               | 3D: 3-Way Head             |
| Type                      | Tripod                     |
| Min. Height - Max. Height | 36,5 -106.5 cm             |
| Maximum Profile Thickness | 16.8 mm                    |
| Weight                    | 520 g                      |

- The 3D tilt head allows perfect alignment for landscape and portrait shots
- Quick-release plate for quickly changing the camera
- Spirit level integrated into the tripod head
- Continuous height adjustment of the centre column
- Leg braces and rubber feet for a firm and steady grip
- With the functional quick-action leg locks the tripod legs can easily and quickly be fixed at the required height or position

|           |    |    |  |                 |
|-----------|----|----|--|-----------------|
| Champagne |    |    |  | <b>00004105</b> |
|           | 15 | SC |  |                 |



**hama**

"Star 20" Tripod

|                           |                            |
|---------------------------|----------------------------|
| Thread/Connection         | 1/4" (6.4 mm)              |
| Leg Segments              | 3 Sections (2x Extendible) |
| Material                  | Aluminium                  |
| Maximum Load              | 2000 g                     |
| Tripod Head               | 3D: 3-Way Head             |
| Type                      | Tripod                     |
| Min. Height - Max. Height | 47 -125 cm                 |
| Maximum Profile Thickness | 21 mm                      |
| Weight                    | 780 g                      |

- The 3D tilt head allows perfect alignment for landscape and portrait shots
- Quick-release plate for quickly changing the camera
- Spirit level integrated into the tripod head
- Continuous height adjustment of the centre column
- Leg braces and rubber feet for a firm and steady grip
- With the functional quick-action leg locks the tripod legs can easily and quickly be fixed at the required height or position

|        |   |    |  |                 |
|--------|---|----|--|-----------------|
| Silver |   |    |  | <b>00004117</b> |
|        | 9 | SC |  |                 |

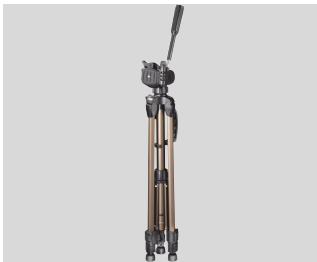

**hama**

"Star 61" Tripod

|                           |                            |
|---------------------------|----------------------------|
| Thread/Connection         | 1/4" (6.4 mm)              |
| Leg Segments              | 3 Sections (2x Extendible) |
| Material                  | Aluminium                  |
| Maximum Load              | 3000 g                     |
| Tripod Head               | 3D: 3-Way Head             |
| Type                      | Tripod                     |
| Min. Height - Max. Height | 60 -153 cm                 |
| Maximum Profile Thickness | 20 mm                      |
| Weight                    | 1220 g                     |

- The 3D tilt head allows perfect alignment for landscape and portrait shots
- Quick-release plate for quickly changing the camera
- Spirit level integrated into the tripod head and spirit vial at the base
- With crank for continuous height adjustment of the centre column
- Lockable leg braces and flexible rubber feet for a firm and steady grip on uneven surfaces
- With the functional quick-action leg locks the tripod legs can easily and quickly be fixed at the required height or position
- Handle
- With hook for weighing the tripod down in strong winds and on rough terrain
- Spare quick release plate: Hama item no. 00004154

|           |                 |
|-----------|-----------------|
| Champagne | <b>00004161</b> |
|           | 6 SC            |

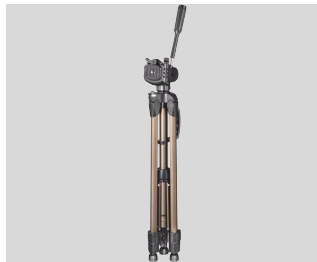

**hama**

"Star 62" Tripod

|                           |                            |
|---------------------------|----------------------------|
| Thread/Connection         | 1/4" (6.4 mm)              |
| Leg Segments              | 3 Sections (2x Extendible) |
| Material                  | Aluminium                  |
| Maximum Load              | 4000 g                     |
| Tripod Head               | 3D: 3-Way Head             |
| Type                      | Tripod                     |
| Min. Height - Max. Height | 64 -160 cm                 |
| Maximum Profile Thickness | 23 mm                      |
| Weight                    | 1500 g                     |

- The 3D tilt head allows perfect alignment for landscape and portrait shots
- Quick-release plate for quickly changing the camera
- Spirit level integrated into the tripod head and spirit vial at the base
- With crank for continuous height adjustment of the centre column
- Lockable leg braces and flexible rubber feet for a firm and steady grip on uneven surfaces
- With the functional quick-action leg locks the tripod legs can easily and quickly be fixed at the required height or position
- Handle
- With hook for weighing the tripod down in strong winds and on rough terrain
- Spare quick release plate: Hama item no. 00004154

|           |                 |
|-----------|-----------------|
| Champagne | <b>00004162</b> |
|           | 6 SC            |



**hama**

"Star 63" Tripod

|                           |                            |
|---------------------------|----------------------------|
| Thread/Connection         | 1/4" (6.4 mm)              |
| Leg Segments              | 3 Sections (2x Extendible) |
| Material                  | Aluminium                  |
| Maximum Load              | 4000 g                     |
| Tripod Head               | 3D: 3-Way Head             |
| Type                      | Tripod                     |
| Min. Height - Max. Height | 66 -166 cm                 |
| Maximum Profile Thickness | 26.7 mm                    |
| Weight                    | 1740 g                     |

- The 3D tilt head allows perfect alignment for landscape and portrait shots
- Quick-release plate for quickly changing the camera
- Spirit level integrated into the tripod head and spirit vial at the base
- With crank for continuous height adjustment of the centre column
- Lockable leg braces and flexible rubber feet for a firm and steady grip on uneven surfaces
- With the functional quick-action leg locks the tripod legs can easily and quickly be fixed at the required height or position
- Handle
- With hook for weighing the tripod down in strong winds and on rough terrain
- Spare quick release plate: Hama item no. 00004154

|           |                 |
|-----------|-----------------|
| Champagne | <b>00004163</b> |
|           | 6 SC            |



**hama**

"Star 64" Tripod

|                           |                            |
|---------------------------|----------------------------|
| Thread/Connection         | 1/4" (6.4 mm)              |
| Leg Segments              | 3 Sections (2x Extendible) |
| Material                  | Aluminium                  |
| Maximum Load              | 4000 g                     |
| Tripod Head               | 3D: 3-Way Head             |
| Type                      | Tripod                     |
| Min. Height - Max. Height | 69 -185 cm                 |
| Maximum Profile Thickness | 26.7 mm                    |
| Weight                    | 1660 g                     |

- The 3D tilt head allows perfect alignment for landscape and portrait shots
- Quick-release plate for quickly changing the camera
- Spirit level integrated into the tripod head and spirit vial at the base
- With crank for continuous height adjustment of the centre column
- Lockable leg braces and flexible rubber feet for a firm and steady grip on uneven surfaces
- With the functional quick-action leg locks the tripod legs can easily and quickly be fixed at the required height or position
- Handle
- With hook for weighing the tripod down in strong winds and on rough terrain
- Spare quick release plate: Hama item no. 00004154

|           |                 |
|-----------|-----------------|
| Champagne | <b>00004464</b> |
|           | 6 SC            |



TRIPODS & ACCESSORIES

# Monopods & Tripods

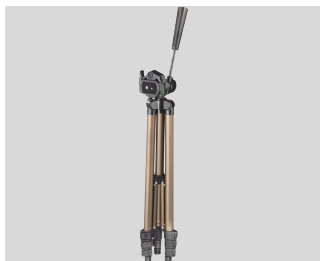

**hama**

"Star 75" Tripod

|                           |                            |
|---------------------------|----------------------------|
| Thread/Connection         | 1/4" (6.4 mm)              |
| Leg Segments              | 4 Sections (3x Extendible) |
| Material                  | Aluminium                  |
| Maximum Load              | 2500 g                     |
| Tripod Head               | 3D: 3-Way Head             |
| Type                      | Tripod                     |
| Min. Height - Max. Height | 42.5 -125 cm               |
| Maximum Profile Thickness | 19.8 mm                    |
| Weight                    | 620 g                      |

- The 3D tilt head allows perfect alignment for landscape and portrait shots
- Quick-release plate for quickly changing the camera
- Spirit level integrated into the tripod head
- Continuous height adjustment of the centre column
- Leg braces and rubber feet for a firm and steady grip
- With the functional quick-action leg locks the tripod legs can easily and quickly be fixed at the required height or position

|           |    |    |  |                 |
|-----------|----|----|--|-----------------|
| Champagne |    |    |  | <b>00004175</b> |
|           | 15 | SC |  |                 |

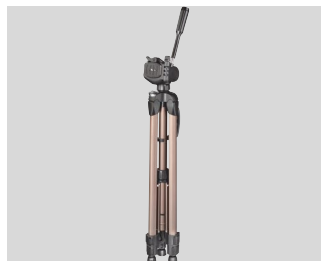

**hama**

"Star 700 EF Digital" Tripod

|                           |                            |
|---------------------------|----------------------------|
| Thread/Connection         | 1/4" (6.4 mm)              |
| Leg Segments              | 4 Sections (3x Extendible) |
| Material                  | Aluminium                  |
| Maximum Load              | 2500 g                     |
| Tripod Head               | 3D: 3-Way Head             |
| Type                      | Tripod                     |
| Min. Height - Max. Height | 42.5 -125 cm               |
| Maximum Profile Thickness | 19.8 mm                    |
| Weight                    | 620 g                      |

- The 3D tilt head allows perfect alignment for landscape and portrait shots
- Spirit level integrated into the tripod head
- Continuous height adjustment of the centre column
- Leg braces and rubber feet for a firm and steady grip
- With the functional quick-action leg locks the tripod legs can easily and quickly be fixed at the required height or position

|           |    |    |  |                 |
|-----------|----|----|--|-----------------|
| Champagne |    |    |  | <b>00004133</b> |
|           | 15 | SC |  |                 |



**hama**

"Traveller 117 Ball" Tripod

|                           |                            |
|---------------------------|----------------------------|
| Thread/Connection         | 1/4" (6.4 mm)              |
| Leg Segments              | 3 Sections (2x Extendible) |
| Material                  | Aluminium                  |
| Maximum Load              | 4000 g                     |
| Tripod Head               | 3-Way Head                 |
| Type                      | Tripod                     |
| Min. Height - Max. Height | 35 -117 cm                 |
| Maximum Profile Thickness | 20 mm                      |
| Weight                    | 820 g                      |

- The ball head allows perfect alignment for shots in portrait and landscape format
- Its compact size makes it ideal for travelling, holidays, hikes and outdoor trips
- Lightweight aluminium design
- With the functional quick-action leg locks the tripod legs can easily and quickly be fixed at the required height or position
- Rubber feet for a firm and steady grip
- The legs are covered with non-slip foam which makes the tripod suitable for all kinds of weather
- With hook for weighing the tripod down in strong winds and on rough terrain

|       |   |    |  |                 |
|-------|---|----|--|-----------------|
| Black |   |    |  | <b>00004290</b> |
|       | 6 | SC |  |                 |



**hama**

"Traveller 163 Ball" Tripod

|                           |                            |
|---------------------------|----------------------------|
| Thread/Connection         | 1/4" (6.4 mm)              |
| Leg Segments              | 3 Sections (2x Extendible) |
| Material                  | Aluminium                  |
| Maximum Load              | 4000 g                     |
| Tripod Head               | 3-Way Head                 |
| Type                      | Tripod                     |
| Min. Height - Max. Height | 47 -163 cm                 |
| Maximum Profile Thickness | 23 mm                      |
| Weight                    | 1350 g                     |

- The ball head allows perfect alignment for shots in portrait and landscape format
- Quick-release plate for quickly changing the camera
- Inverted position allows macrophotographs near the ground
- The spikes at the tripod feet ensure that a particularly firm and steady grip is maintained on soft or slippery surfaces
- Its compact size makes it ideal for travelling, holidays, hikes and outdoor trips
- Lightweight aluminium design
- Spirit vial at the ball head
- Quick release plate with safety catch and "click function" for quick and easy camera change with just one click
- Brake for locking the centre column into place
- With the functional quick-action leg locks the tripod legs can easily and quickly be fixed at the required height or position
- Expandable legs for optimum proximity to the ground
- Rubber feet for a firm and steady grip

|       |   |    |  |                 |
|-------|---|----|--|-----------------|
| Black |   |    |  | <b>00004291</b> |
|       | 6 | SC |  |                 |



TRIPODS & ACCESSORIES





## hama

### "Gamma 153" Tripod, 3D

|                           |                            |
|---------------------------|----------------------------|
| Thread/Connection         | 1/4" (6.4 mm)              |
| Leg Segments              | 3 Sections (2x Extendible) |
| Material                  | Aluminium                  |
| Maximum Load              | 3000 g                     |
| Tripod Head               | 3-Way Head                 |
| Type                      | Tripod                     |
| Min. Height - Max. Height | 58 -153 cm                 |
| Maximum Profile Thickness | 20 mm                      |
| Weight                    | 990 g                      |

- The 3D tilt head allows perfect alignment for landscape and portrait shots
- Quick-release plate for quickly changing the camera
- Spirit vial at the base
- Crank for continuous height adjustment of the central column
- With the functional quick-action leg locks the tripod legs can easily and quickly be fixed at the required height or position
- Handle
- Spare quick release plate: Hama item no. 00004154

|       |  |  |    |    |  |  |  |  |  |                 |
|-------|--|--|----|----|--|--|--|--|--|-----------------|
| Black |  |  |    |    |  |  |  |  |  | <b>00004096</b> |
|       |  |  | 10 | SC |  |  |  |  |  |                 |



## hama

### "Delta Duo 170" Tripod, 3D

|                           |                            |
|---------------------------|----------------------------|
| Thread/Connection         | 1/4" (6.4 mm)              |
| Leg Segments              | 3 Sections (2x Extendible) |
| Material                  | Aluminium                  |
| Maximum Load              | 4000 g                     |
| Tripod Head               | 3-Way Head                 |
| Type                      | Tripod                     |
| Min. Height - Max. Height | 62 -170 cm                 |
| Maximum Profile Thickness | 26 mm                      |
| Weight                    | 1850 g                     |

- The 3D tilt head allows perfect alignment for landscape and portrait shots
- Quick-release plate for quickly changing the camera
- The central column can be removed to be used as a fully functioning monopod
- Large, functional quick-action leg locks for fast and simple locking of the leg length in any position
- Spirit level integrated into the tripod head and base
- With rubber feet for secure stand
- Spikes on the tripod feet ensure an especially sturdy position on soft or slippery surfaces
- Monopod, min. height 59 cm/max. height 148 cm
- Replacement quick coupling plate (rubber): Item No. 00004424

|       |  |  |   |    |  |  |  |  |  |                 |
|-------|--|--|---|----|--|--|--|--|--|-----------------|
| Black |  |  |   |    |  |  |  |  |  | <b>00004098</b> |
|       |  |  | 6 | SC |  |  |  |  |  |                 |



## hama

### "Ramble II Duo Carbon" Tripod, 160 Ball, with Smartphone Holder

|                           |                                   |
|---------------------------|-----------------------------------|
| Thread/Connection         | 1/4" (6.4 mm), Smartphone holder  |
| Leg Segments              | 4 Sections (3x Extendible)        |
| Material                  | Carbon                            |
| Maximum Load              | 8000 g                            |
| Tripod Head               | Ball Head with Panoramic Function |
| Type                      | Mono Tripod/Tripod                |
| Min. Height - Max. Height | 46 -160 cm                        |
| Maximum Profile Thickness | 25 mm                             |
| Weight                    | 1620 g                            |

- Ball head with panorama function allows perfect orientation for recording in portrait and landscape
- Quick-release plate for quickly changing the camera
- Inverted position allows macrophotographs near the ground
- The spikes at the tripod feet ensure that a particularly firm and steady grip is maintained on soft or slippery surfaces
- In combination with a leg segment the removable central column can be used as a fully functioning monopod
- With the combination of the tripod and holder, take blur-free photographs with the smartphone- Extremely lightweight and sturdy carbon construction
- With rubber feet for secure stand

|        |  |  |   |    |  |  |  |  |  |                 |
|--------|--|--|---|----|--|--|--|--|--|-----------------|
| Carbon |  |  |   |    |  |  |  |  |  | <b>00004486</b> |
|        |  |  | 6 | SC |  |  |  |  |  |                 |



## hama

### Tripod "Star 78 Mono"

|                           |                            |
|---------------------------|----------------------------|
| Thread/Connection         | 1/4" (6.4 mm)              |
| Leg Segments              | 4 Sections (3x Extendible) |
| Material                  | Aluminium                  |
| Maximum Load              | 4000 g                     |
| Tripod Head               | 3D: 3-Way Head             |
| Type                      | Mono Tripod                |
| Min. Height - Max. Height | 61 -176 cm                 |
| Maximum Profile Thickness | 26.7 mm                    |
| Weight                    | 665 g                      |

- The 3D tilt head allows perfect alignment for landscape and portrait shots
- Quick-release plate for quickly changing the camera
- Flexible rubber foot for a firm grip on uneven surfaces and for easy camera alignment in different positions
- With the functional quick-action leg locks the leg of the monopod can easily and quickly be fixed at the required height or position
- Spirit level integrated into the monopod head
- The non-slip, rubber-coated handle allows you to use the monopod in all weathers
- Spare quick release plate: Hama item no. 00004154

|           |  |  |    |    |  |  |  |  |  |                 |
|-----------|--|--|----|----|--|--|--|--|--|-----------------|
| Champagne |  |  |    |    |  |  |  |  |  | <b>00004178</b> |
|           |  |  | 10 | SC |  |  |  |  |  |                 |

# Monopods & Tripods



**hama**

**"Smooth" Monostand, 155 Click, with Three-Arm Base**

|                           |                            |
|---------------------------|----------------------------|
| Thread/Connection         | 1/4" (6.4 mm)              |
| Leg Segments              | 4 Sections (3x Extendible) |
| Material                  | Aluminium                  |
| Maximum Load              | 5000 g                     |
| Tripod Head               | No                         |
| Type                      | Mono Tripod                |
| Min. Height - Max. Height | 63,5 -155 cm               |
| Maximum Profile Thickness | 28 mm                      |
| Weight                    | 900 g                      |

- Air lock system: stepless adjustment without screw clamps - for more speed when hunting for the perfect shot
- A cleverly attached joint at the end of the tripod ensures gentle and smooth movements and pivoting, with the joint allowing tilts of up to 20° in all directions
- Flexible alternative to large tripods: ideal when things have to happen fast, if there's not much space for a large tripod, for example, for photographing with large lenses, for animal shots with large focal lengths
- Also for fascinating 360° panoramic shots and vivid indoor and property photographs
- The monopod's three leg segments are extendable, and each of them is individually steplessly adjustable, making them perfect for custom positioning even up to eye level height
- Made from sturdy and lightweight aluminium, weighing 900 grams and, thanks to its small dimensions, is also suitable for travel

|       |    |    |  |                 |
|-------|----|----|--|-----------------|
| Black |    |    |  | <b>00004468</b> |
|       | 12 | SC |  |                 |

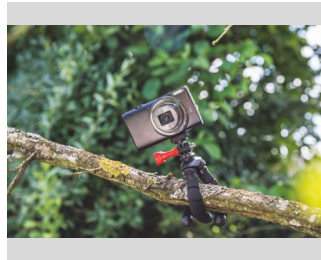

**hama**

**"Flex 2in1" Mini-Tripod for Photo Cameras and GoPro, 14 cm**

|                           |                      |
|---------------------------|----------------------|
| Thread/Connection         | 1/4" (6.4 mm), GoPro |
| Leg Segments              | 1 Section            |
| Material                  | Aluminium            |
| Maximum Load              | 300 g                |
| Type                      | Bendable Tripod      |
| Min. Height - Max. Height | 7.5 -14 cm           |
| Weight                    | 64 g                 |

- The flexible legs are capable of bending up to 360° which allows optimal, secure attachment to various objects, e.g. railings, branches
- 2in1 system for 1/4 inch threads and GoPro cameras
- Its compact size makes it ideal for travelling, holidays, hikes and outdoor trips
- Non-slip foam on the tripod legs
- Can of course also be used as a normal table tripod

|       |   |    |  |                 |
|-------|---|----|--|-----------------|
| Black |   |    |  | <b>00004557</b> |
|       | 6 | HB |  |                 |



**hama**

**"Flex 2in1" Tripod for Photo Cameras and GoPro, 26 cm**

|                           |                      |
|---------------------------|----------------------|
| Thread/Connection         | 1/4" (6.4 mm), GoPro |
| Leg Segments              | 1 Section            |
| Material                  | Aluminium            |
| Type                      | Bendable Tripod      |
| Min. Height - Max. Height | 10 -26 cm            |
| Weight                    | 145 g                |

- The flexible legs are capable of bending up to 360° which allows optimal, secure attachment to various objects, e.g. railings, branches
- 2in1 system for 1/4 inch threads and GoPro cameras
- Handy travel format for easy transport in a bag or back pack
- Non-slip foam on the tripod legs
- Can of course also be used as a normal table tripod

|       |   |    |  |                 |
|-------|---|----|--|-----------------|
| Black |   |    |  | <b>00004558</b> |
|       | 6 | HB |  |                 |



**hama**

**"Flexi" Mini Tripod M, 20 Pcs in Display**

|                           |                 |
|---------------------------|-----------------|
| Thread/Connection         | 1/4" (6.4 mm)   |
| Leg Segments              | 1 Section       |
| Material                  | Metal           |
| Tripod Head               | No              |
| Type                      | Bendable Tripod |
| Min. Height - Max. Height | 7 -10 cm        |
| Weight                    | 58 g            |

- With clip for attaching to a camera bag, belt or shirt pocket, etc.
- Compact mini-tripod with flexible legs
- Can be used as a tabletop tripod for all compact cameras with 1/4" (6.4 mm) tripod thread

|       |    |    |  |                 |
|-------|----|----|--|-----------------|
| Black |    |    |  | <b>00004553</b> |
|       | 20 | SC |  |                 |

TRIPODS & ACCESSORIES



**hama**

"Flexi" Mini-Tripod, M, black

|                           |                  |
|---------------------------|------------------|
| Thread/Connection         | 1/4" (6.4 mm)    |
| Leg Segments              | 1 Section        |
| Material                  | Plastic Material |
| Maximum Load              | 200 g            |
| Tripod Head               | No               |
| Type                      | Bendable Tripod  |
| Min. Height - Max. Height | 7 -10 cm         |

- With clip for attaching to a camera bag, belt or shirt pocket, etc.
- Compact mini-tripod with flexible legs
- Can be used as a tabletop tripod for all compact cameras with 1/4" (6.4 mm) tripod thread

|       |          |
|-------|----------|
| Black | 00004552 |
| 6     | HB       |



**hama**

Tripod  
"Ball L"

|                           |                            |
|---------------------------|----------------------------|
| Thread/Connection         | 1/4" (6.4 mm)              |
| Leg Segments              | 2 Sections (1x Extendible) |
| Material                  | Aluminium                  |
| Maximum Load              | 300 g                      |
| Tripod Head               | 3D Ball Head               |
| Type                      | Mini Tripod                |
| Min. Height - Max. Height | 14 -21 cm                  |
| Weight                    | 114 g                      |

- The ball head allows perfect alignment for shots in portrait and landscape format
- For photo and video cameras, micro-phones and mini-loudspeakers

|        |          |
|--------|----------|
| Silver | 00004551 |
| Black  | 00004555 |
| 6      | HB       |



**hama**

"Ball" Mini-Tripod, L Mini,  
black

|                           |                            |
|---------------------------|----------------------------|
| Thread/Connection         | 1/4" (6.4 mm), 3D, Ball    |
| Leg Segments              | 4 Sections (3x Extendible) |
| Material                  | Metal                      |
| Tripod Head               | 3D Ball Head               |
| Type                      | Mini Tripod                |
| Min. Height - Max. Height | 10.5 -19 cm                |
| Weight                    | 110 g                      |

- The ball head allows perfect alignment for shots in portrait and landscape format
- For photo and video cameras, micro-phones and mini-loudspeakers

|       |          |
|-------|----------|
| Black | 00004554 |
| 6     | HB       |



**hama**

"Ball" Mini-Tripod, XL, black/  
silver

|                           |                            |
|---------------------------|----------------------------|
| Thread/Connection         | 1/4" (6.4 mm), 3D, Ball    |
| Leg Segments              | 3 Sections (2x Extendible) |
| Material                  | Plastic Material           |
| Maximum Load              | 300 g                      |
| Tripod Head               | 3D Ball Head               |
| Type                      | Mini Tripod                |
| Min. Height - Max. Height | 14 -26 cm                  |

- The ball head allows perfect alignment for shots in portrait and landscape format
- For photo and video cameras, micro-phones and mini-loudspeakers

|       |          |
|-------|----------|
| Black | 00004556 |
| 6     | HB       |



TRIPODS & ACCESSORIES

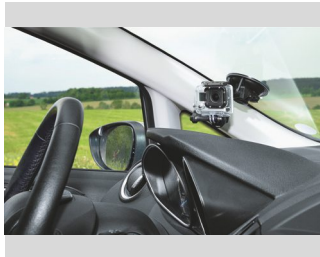

**hama**

### Suction Mount with Ball Head 360 for GoPro

|              |                  |
|--------------|------------------|
| Material     | Plastic Material |
| Maximum Load | 300 g            |
| Type         | Suction Stand    |
| Weight       | 180 g            |

- The ball head allows perfect alignment for shots in portrait and landscape format
- For GoPro action cameras and digital cameras with a 1/4" connection thread
- 3D ball head with 360° rotation
- Can also be used as a car pod
- Diameter of the suction cup: 90 mm
- Thread length adjustable, therefore universally usable

|       |  |   |    |                 |
|-------|--|---|----|-----------------|
| Black |  |   |    | <b>00004356</b> |
|       |  | 6 | BK |                 |



**hama**

### Lighting Tripod 200

|                           |               |
|---------------------------|---------------|
| Thread/Connection         | 1/4" (6.4 mm) |
| Leg Segments              | 1 Section     |
| Material                  | Metal         |
| Maximum Load              | 2500 g        |
| Tripod Head               | No            |
| Type                      | Light Stand   |
| Min. Height - Max. Height | 75 -200 cm    |
| Maximum Profile Thickness | 24 mm         |
| Weight                    | 980 g         |

- Stable design thanks to cross-struts
- Functional quick-action leg locks for rapid and simple locking
- Especially lightweight, therefore ideal for shots outside the studio

|       |  |   |    |                 |
|-------|--|---|----|-----------------|
| Black |  |   |    | <b>00004084</b> |
|       |  | 6 | SC |                 |

#### Ball Joint/Tilt Head



**hama**

### Ball Head, height: 50 mm

|                   |               |
|-------------------|---------------|
| Thread/Connection | 1/4" (6.4 mm) |
| Diameter          | 30 mm         |
| Height            | 50 mm         |
| Weight            | 114 g         |

- (A) 1/4" (6.4 mm) camera screw
- (B) 1/4" (6.4 mm) and (B) 3/8" (9.5 mm) screw hole

|       |  |   |    |                 |
|-------|--|---|----|-----------------|
| Black |  |   |    | <b>00005014</b> |
|       |  | 6 | BK |                 |



**hama**

### Ball Head, height: 38 mm

|                   |               |
|-------------------|---------------|
| Thread/Connection | 1/4" (6.4 mm) |
| Diameter          | 20 mm         |
| Height            | 38 mm         |
| Weight            | 36 g          |

- (B) 1/4" (6.4 mm) screw hole
- (A) 1/4" (6.4 mm) camera screw

|       |  |   |    |                 |
|-------|--|---|----|-----------------|
| Black |  |   |    | <b>00005011</b> |
|       |  | 6 | BK |                 |

#### Camera Quick-Release System



**hama**

### Quick Release Plate, 41.7 x 41.7 mm, Photo/Video

|                 |                  |
|-----------------|------------------|
| Shade of colour | Black            |
| Material        | Plastic Material |
| Width x Height  | 4.17 x 4.17 cm   |

- For lightweight cameras, SLR and camcorders
- High-quality, reinforced plastic
- Camera plate with A 1/4" (6.4 mm) screw and sprung video pin
- Suitable e.g. for item no. 00004352

|  |  |   |    |                 |
|--|--|---|----|-----------------|
|  |  |   |    | <b>00004360</b> |
|  |  | 6 | BK |                 |

Camera Plate



**hama**

Quick Release Plate for Delta Pro 180 Ball

|                 |           |
|-----------------|-----------|
| Shade of colour | Black     |
| Material        | Aluminium |
| Width x Height  | 6 x 5 cm  |

|               |                 |
|---------------|-----------------|
| 1/4" (6.4 mm) | <b>00004414</b> |
| 6 BK          |                 |



**hama**

Tripod Camera Plate for Traveller 150 Prem. Duo & Prof. Premium Duo Carbon

|                 |           |
|-----------------|-----------|
| Shade of colour | Black     |
| Material        | Aluminium |
| Width x Height  | 4 x 4 cm  |

- For "Traveller 150 Premium Duo" tripod, Item No.: 00004265
- For "Professional Premium Duo Carbon" tripod, Art. No.: 00004286

|               |                 |
|---------------|-----------------|
| 1/4" (6.4 mm) | <b>00004246</b> |
| 6 BK          |                 |



**hama**

Quick-release Plate for Tripod, Arca-Swiss-Compatible

|                 |            |
|-----------------|------------|
| Shade of colour | Black      |
| Material        | Aluminium  |
| Width x Height  | 5 x 3.9 cm |

|               |                 |
|---------------|-----------------|
| 1/4" (6.4 mm) | <b>00004463</b> |
| 6 BK          |                 |



**hama**

Quick Release Plate for Delta Pro 180 2D

|                 |              |
|-----------------|--------------|
| Shade of colour | Black        |
| Material        | Cork         |
| Width x Height  | 5.1 x 5.1 cm |

- Video locating pin

|               |                 |
|---------------|-----------------|
| 1/4" (6.4 mm) | <b>00004413</b> |
| 6 BK          |                 |



**hama**

Quick Release Plate for Traveller Premium 144/146

|                 |            |
|-----------------|------------|
| Shade of colour | Black      |
| Material        | Aluminium  |
| Width x Height  | 4 x 3.5 cm |

|               |                 |
|---------------|-----------------|
| 1/4" (6.4 mm) | <b>00004243</b> |
| 6 BK          |                 |



**hama**

Quick Release Plate for Profi Duo 170 3D

|                 |              |
|-----------------|--------------|
| Shade of colour | Black        |
| Material        | Aluminium    |
| Width x Height  | 6,5 x 4.1 cm |

|               |                 |
|---------------|-----------------|
| 1/4" (6.4 mm) | <b>00004512</b> |
| 6 BK          |                 |



**hama**

"Click II" Tripod Camera Plate

|                 |                |
|-----------------|----------------|
| Shade of colour | Black          |
| Material        | Aluminium      |
| Width x Height  | 4.08 x 4.08 cm |

- For Gamma tripods
- For lightweight SLR cameras and camcorders
- High-quality, reinforced plastic, spring video pin, camera plate with A 1/4" screw (6.4 mm)

|               |                 |
|---------------|-----------------|
| 1/4" (6.4 mm) | <b>00004376</b> |
| 6 BK          |                 |



**hama**

Quick Release Plate for "Traveller 163 Ball" Tripod

|                 |            |
|-----------------|------------|
| Shade of colour | Black      |
| Material        | Cork       |
| Width x Height  | 4 x 3.9 cm |

|               |                 |
|---------------|-----------------|
| 1/4" (6.4 mm) | <b>00004439</b> |
| 6 BK          |                 |



TRIPODS & ACCESSORIES

# Tripod Accessories



**hama**

Quick Release Plate for Delta Pro 180 3D

|                 |            |
|-----------------|------------|
| Shade of colour | Black      |
| Material        | Cork       |
| Width x Height  | 8 x 4.8 cm |

- Video locating pin

|               |                 |
|---------------|-----------------|
| 1/4" (6.4 mm) | <b>00004415</b> |
| 6 BK          |                 |



**hama**

Quick Release Plate for "Star 55-64", "Star 200", "Gamma 153", "Action 165"

|                 |                  |
|-----------------|------------------|
| Shade of colour | Black            |
| Material        | Plastic Material |
| Width x Height  | 6.6 x 5.1 cm     |

|               |                 |
|---------------|-----------------|
| 1/4" (6.4 mm) | <b>00004154</b> |
| 6 BK          |                 |



**hama**

Quick Release Plate for "Delta 160", 3D/"Delta Duo 170", 3D Tripods

|                 |                  |
|-----------------|------------------|
| Shade of colour | Black            |
| Material        | Plastic Material |
| Width x Height  | 7 x 5.2 cm       |

- Video pin

|               |                 |
|---------------|-----------------|
| 1/4" (6.4 mm) | <b>00004424</b> |
| 6 BK          |                 |



**hama**

Tripod Camera Plate for "Star 75" Tripod

|                 |                  |
|-----------------|------------------|
| Shade of colour | Black            |
| Material        | Plastic Material |
| Width x Height  | 4.7 x 3.5 cm     |

- With video pin

|               |                 |
|---------------|-----------------|
| 1/4" (6.4 mm) | <b>00004008</b> |
| 6 BK          |                 |



**hama**

Quick-Release Plate for Omega Premium I, II and III

|                 |                  |
|-----------------|------------------|
| Shade of colour | Black            |
| Material        | Plastic Material |
| Width x Height  | 5.3 x 4.2 cm     |

|               |                 |
|---------------|-----------------|
| 1/4" (6.4 mm) | <b>00004262</b> |
| 6 BK          |                 |



**hama**

Quick-Release Coupling Platform for "Profil Duo" Tripod, 150 - 3D

|                 |                  |
|-----------------|------------------|
| Shade of colour | Black            |
| Material        | Plastic Material |
| Width x Height  | 4.2 x 5.8 cm     |

- With video pin

|               |                 |
|---------------|-----------------|
| 1/4" (6.4 mm) | <b>00004471</b> |
| 6 BK          |                 |



**hama**

Tripod Camera Plate for "Star 20" Three-Legged Tripod

|                 |                  |
|-----------------|------------------|
| Shade of colour | Black            |
| Material        | Plastic Material |
| Width x Height  | 4.2 x 3.7 cm     |

- With video pin

|               |                 |
|---------------|-----------------|
| 1/4" (6.4 mm) | <b>00004229</b> |
| 6 BK          |                 |

TRIPODS & ACCESSORIES

# Tripod Accessories | Mounting Materials

## Conversion Bushings



**hama**

Adaptermount 1/4" to 3/8"  
"GS5000", Silver

- (A) 3/8" (9.5 mm) threaded stem
- (B) 1/4" (6.4 mm) threaded hole

|  |   |    |          |
|--|---|----|----------|
|  |   |    | 00005120 |
|  | 6 | BK |          |

## Socket



**hama**

Tripod Conversion Screws,  
(A) 1/4" (6.4 mm) > (B) 3/8"  
(9.5 mm)

|                 |        |
|-----------------|--------|
| Shade of colour | Silver |
| Diameter        | 25 mm  |

- (A) 1/4" (6.4 mm) threaded stem
- (B) 3/8" (9.5 mm) threaded hole

|  |   |    |          |
|--|---|----|----------|
|  |   |    | 00005121 |
|  | 6 | BK |          |



**hama**

Tripod Conversion Screws,  
(A) 3/8" (9.5 mm) > (B) 1/4"  
(6.4 mm)

|                 |        |
|-----------------|--------|
| Shade of colour | Silver |
| Diameter        | 25 mm  |

- (A) 3/8" (9.5 mm) threaded stem
- (B) 1/4" (6.4 mm) threaded hole

|  |   |    |          |
|--|---|----|----------|
|  |   |    | 00005122 |
|  | 6 | BK |          |

## Clamp Extensions



**hama**

"Studio Clamp 40", Set of 3

|       |       |
|-------|-------|
| Shape | Wedge |
|-------|-------|

- Powerful spring clamp
- Support opening: approx. 60 mm, clamping width: approx. 40 mm
- Width: approx. 80 mm

|  |    |    |          |
|--|----|----|----------|
|  |    |    | 00021205 |
|  | 30 | HB |          |

## Screw



**hama**

Metal Camera Screws

- (A) 1/4" (6.4 mm) threaded stem
- (B) 1/4" (6.4 mm) threaded hole

|  |   |    |          |
|--|---|----|----------|
|  |   |    | 00005124 |
|  | 6 | BK |          |



**hama**

Camera Screws, 11 mm

- (A) 1/4" (6.4 mm) threaded mount
- (B) 1/4" (6.4 mm) threaded hole

|  |   |    |          |
|--|---|----|----------|
|  |   |    | 00005134 |
|  | 6 | BK |          |

TRIPODS & ACCESSORIES





# Filter & Accessories

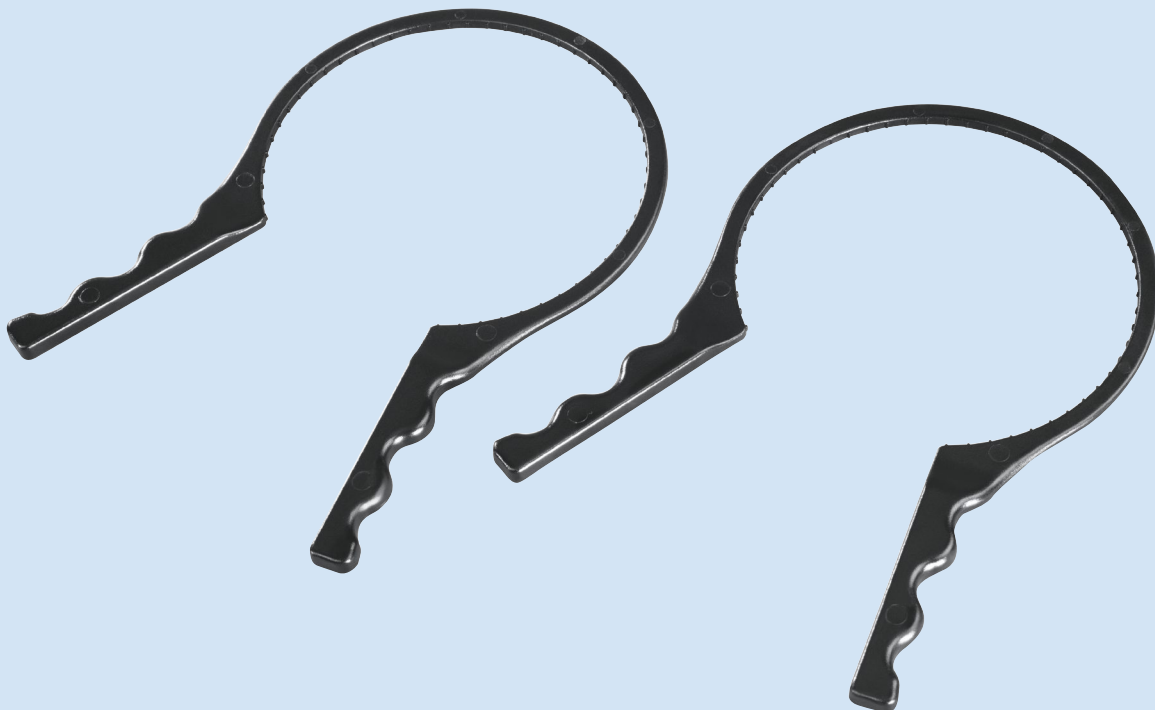

# Picture Frames | Photo filter

## Clips/Clamp



**hama**

2 Filter Clamps, 49 - 58 cm

|                 |       |
|-----------------|-------|
| Shade of colour | Black |
|-----------------|-------|

- For filters or other screwable lens attachments with a diameter between 49 and 58 mm

|          |    |  |
|----------|----|--|
| 00005896 |    |  |
| 6        | BK |  |

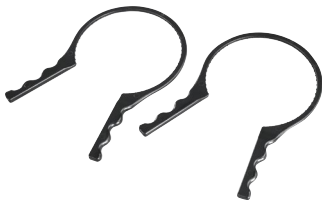

**hama**

2 Filter Clamps, 62 - 86 mm

|                 |       |
|-----------------|-------|
| Shade of colour | Black |
|-----------------|-------|

- For filters or other screwable lens attachments with a diameter between 62 and 86 mm

|          |    |  |
|----------|----|--|
| 00005897 |    |  |
| 6        | BK |  |

## Lens filter



**hama**

Lens filter  
"Gray Filter Set ND58, ND64, ND100, with Filter Bag"

|                 |                                   |
|-----------------|-----------------------------------|
| Coating         | NMC16 (Nano Multi-Coated 16-fold) |
| Metal Mount     | Black                             |
| Mount Thickness | 2.9 mm                            |
| Type            | Grey Filter                       |
| Type of Glass   | High-Grade Lens Glass             |

- Exposure correction: 8x = 3 aperture values; 64 = 6 aperture values; 1000 = 10 aperture values
- NMC16 coating: eight layers on each side, for maximum anti-reflective properties
- Vapour-deposited nano-coating
- Developed especially for digital cameras thanks to double-sided coating
- With front thread for other filters, lens cap or lens hood
- Quality class (glass): high-quality lens glass

Picture impact:

- Running water is portrayed as soft and flowing by long exposure times
- Popular squares become void of people through long-term exposure

|       |          |
|-------|----------|
| 58 mm | 00076899 |
|       | 10 HB    |
| 62 mm | 00076900 |
|       | 10 HB    |
| 67 mm | 00076901 |
|       | 10 HB    |
| 72 mm | 00076902 |
|       | 10 HB    |
| 77 mm | 00076903 |
|       | 10 HB    |
| 82 mm | 00076904 |
|       | 10 HB    |

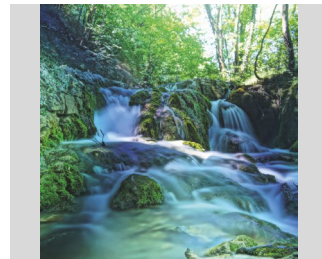

**hama**

Lens filter  
"Gray Filter Vario DC ND-2400, DC Double Coated"

|                 |                       |
|-----------------|-----------------------|
| Coating         | Coated                |
| Metal Mount     | Black                 |
| Mount Thickness | 7 mm                  |
| Type            | Grey Filter           |
| Type of Glass   | High-Grade Lens Glass |

- Possibility to lengthen the exposure time between +1 and +8 (ND2-400) aperture stops
- Rotary mount for individual adjustment
- Coating: one layer on each side
- Quality standard (glass): high-quality lens glass

Impact on the pictures:

|         |          |
|---------|----------|
| 40.5 mm | 00079141 |
| 49 mm   | 00079149 |
|         | 9 BK     |
| 52 mm   | 00079152 |
|         | 6 BK     |
| 55 mm   | 00079155 |
|         | 6 BK     |
| 58 mm   | 00079158 |
|         | 6 BK     |
| 62 mm   | 00079162 |
|         | 10 BK    |
| 67 mm   | 00079167 |
|         | 6 BK     |
| 72 mm   | 00079172 |
|         | 6 BK     |
| 77 mm   | 00079177 |
|         | 9 BK     |
| 82 mm   | 00079182 |
|         | 9 BK     |



**hama**

Lens filter  
"L Protect Filter Professional, HTMC-8, Wide"

|                 |                  |
|-----------------|------------------|
| Coating         | HTMC (8 x)       |
| Metal Mount     | Black            |
| Mount Thickness | 3 mm             |
| Type            | L-Protect-Filter |
| Type of Glass   | Crown Lens Glass |

- Transparent
- HTMC coating: four layers on each side, for high light transmission
- Quality standard (glass): crown lens glass
- Specially designed for DSLR, system and bridge cameras with wide-angle, wide-angle zoom and travel zoom lenses
- Flat metal mount (only 3 mm), therefore no vignetting (dark shading of picture corners)

|         |          |
|---------|----------|
| 40.5 mm | 00078641 |
| 43 mm   | 00078643 |
|         | 6 HB     |
| 49 mm   | 00078649 |
|         | 6 HB     |
| 52 mm   | 00078652 |
|         | 6 HB     |
| 55 mm   | 00078655 |
|         | 6 HB     |
| 58 mm   | 00078658 |
|         | 6 HB     |
| 62 mm   | 00078662 |
|         | 6 HB     |
| 67 mm   | 00078667 |
|         | 6 HB     |
| 72 mm   | 00078672 |
|         | 6 HB     |
| 77 mm   | 00078677 |
|         | 6 HB     |
| 82 mm   | 00078682 |
|         | 6 HB     |

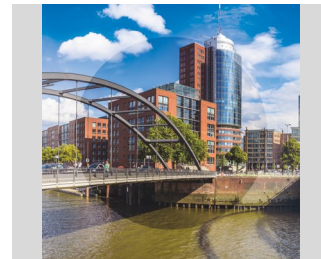
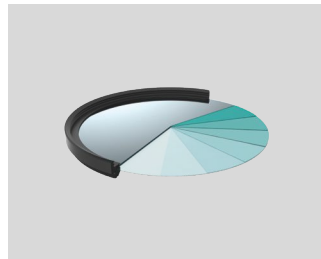
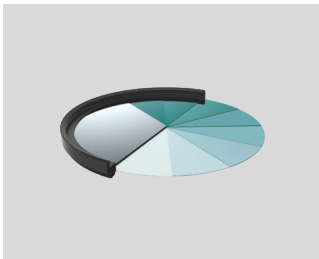

## hama

### Lens filter "Polarization Filter Premium, circular, NSC18 Nano"

|                 |                                   |
|-----------------|-----------------------------------|
| Coating         | NSC18 (Nano Super-Coated 18-fold) |
| Metal Mount     | Black                             |
| Mount Thickness | 4.5 mm                            |
| Type            | Polarization Filter               |
| Type of Glass   | High-Grade Lens Glass             |

- Enhances contrast and brings depth to the picture, e.g. the sky becomes a strong blue, clouds become artificially white, colours are clearer and more intense
- Depending on the filter setting, the contrast and depth vary and non-metallic reflections (water, plastic, glass, etc.) are removed
- Maximum effectiveness with a photographic angle of 30-40° to the reflecting surface
- Ultra-flat and ultra-lightweight rotary mount for variable settings
- Effect filter with effects that cannot be achieved subsequently using an image editing program: objects worth seeing, for example behind shop windows or aquariums, become visible
- NSC18 coating: nine layers on each side, for excellent permeability to light and maximum anti-reflective properties
- Vapour-deposited, multi-layer coating
- Nano-coating for the lotus effect: easy to clean, prevents misting and further dirt accretion, water, oil and dirt-repellent
- Scratch and shock-resistant

|         |          |
|---------|----------|
| 37 mm   | 00077200 |
| 40.5 mm | 00077201 |
| 46 mm   | 00077203 |
| 49 mm   | 00077204 |
|         | 6 HB     |

## hama

### Lens filter "Polarization Filter Profi Line, circular, NMC16 Nano"

|                 |                                   |
|-----------------|-----------------------------------|
| Coating         | NMC16 (Nano Multi-Coated 16-fold) |
| Metal Mount     | Black                             |
| Mount Thickness | 4.5 mm                            |
| Type            | Polarization Filter               |
| Type of Glass   | High-Grade Lens Glass             |

- Enhances contrast and brings depth to the picture, e.g. the sky becomes a strong blue, clouds become artificially white, colours are clearer and more intense
- Depending on the filter setting, the contrast and depth vary and non-metallic reflections (water, plastic, glass, etc.) are removed
- Maximum effectiveness with a photographic angle of 30-40° to the reflecting surface
- Ultra-flat and ultra-lightweight rotary mount for variable settings

|       |          |
|-------|----------|
| 37 mm | 00077100 |
| 49 mm | 00077101 |
| 52 mm | 00077102 |
| 55 mm | 00077103 |
|       | 6 HB     |
| 58 mm | 00077104 |
| 62 mm | 00077105 |
|       | 6 HB     |
| 67 mm | 00077106 |
|       | 6 HB     |
| 77 mm | 00077108 |
|       | 6 HB     |
| 82 mm | 00077109 |
|       | 6 HB     |
| 72 mm | 00077107 |
|       | 6 HB     |

## hama

### Lens filter "Polarization Filter Professional, circular, HTMC-8"

|                 |                     |
|-----------------|---------------------|
| Coating         | HTMC (8 x)          |
| Metal Mount     | Black               |
| Mount Thickness | 4.5 mm              |
| Type            | Polarization Filter |
| Type of Glass   | Crown Lens Glass    |

- Special filter with ultra-flat rotary mount (4.5 mm)
- Protects the lens against scratches, dust and fingerprints, also serves as UV filter
- For wide-angle and wide-angle zoom lenses, especially for fast AF lenses with integrated motor drive or front lens focus
- No vignetting (dark shading of picture corners)
- New, optical glass of superior quality (only 1 mm thick)
- From a focal length of 17 mm (with miniature photographs)

|       |          |
|-------|----------|
| 49 mm | 00078849 |
|       | 6 HB     |
| 52 mm | 00078852 |
|       | 6 HB     |
| 55 mm | 00078855 |
|       | 6 HB     |
| 58 mm | 00078858 |
|       | 6 HB     |
| 62 mm | 00078862 |
|       | 6 HB     |
| 67 mm | 00078867 |
|       | 6 HB     |
| 72 mm | 00078872 |
|       | 6 HB     |
| 77 mm | 00078877 |
|       | 6 HB     |
| 82 mm | 00078882 |
|       | 6 HB     |

## hama

### Lens filter "Polarization Filter AR, circular, multi-coated"

|                 |                       |
|-----------------|-----------------------|
| Coating         | AR Coated (4x)        |
| Metal Mount     | Black                 |
| Mount Thickness | 6 mm                  |
| Type            | Polarization Filter   |
| Type of Glass   | High-Grade Lens Glass |

- Neutral colour
- AR coating: two layers on each side, for better light transmission
- Quality standard (glass): high-quality lens glass
- Rotary mount with a pin

Impact on the pictures:

|         |          |
|---------|----------|
| 37 mm   | 00072537 |
|         | 10 SC    |
| 40.5 mm | 00072541 |
| 46 mm   | 00072546 |
|         | 9 SC     |
| 49 mm   | 00072549 |
|         | 10 SC    |
| 52 mm   | 00072552 |
|         | 10 SC    |
| 55 mm   | 00072555 |
|         | 9 SC     |
| 58 mm   | 00072558 |
|         | 9 SC     |
| 62 mm   | 00072562 |
|         | 10 SC    |
| 67 mm   | 00072567 |
|         | 10 SC    |
| 72 mm   | 00072572 |
|         | 9 SC     |
| 77 mm   | 00072577 |
|         | 10 SC    |
| 82 mm   | 00072582 |
|         | 9 SC     |

# Photo filter



FILTER & ACCESSORIES

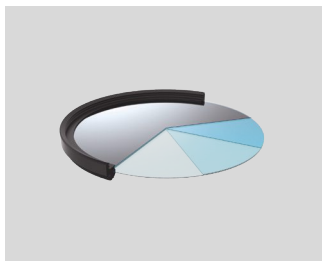

**hama**

**Lens filter**  
"Protect filter „Ultimate“,  
MC8, Wide"

|                 |                       |
|-----------------|-----------------------|
| Coating         | MC8 (8x Multi-Coated) |
| Metal Mount     | Black                 |
| Mount Thickness | 2.4 mm                |
| Type            | Protection Filter     |
| Type of Glass   | Optical Glass         |

- MC8 coating: four layers on each side, for excellent permeability to light and maximum anti-reflective properties
- Vapour-deposited, multi-layer coating
- Scratch-resistant
- Filter front and back are coated, ensuring no loss of contrast or brilliance and preventing ghosting and double images
- Ultra-thin, wide mount: prevents vignetting, can remain on the lens permanently
- Barely increases the lens front section
- A protected front lens saves expensive repair costs
- Quality class (glass): optical glass

|       |  |  |   |    |  |                 |
|-------|--|--|---|----|--|-----------------|
| 37 mm |  |  |   |    |  | <b>00071300</b> |
| 49 mm |  |  |   |    |  | <b>00071301</b> |
|       |  |  | 6 | HB |  |                 |
| 52 mm |  |  |   |    |  | <b>00071302</b> |
|       |  |  | 6 | HB |  |                 |
| 55 mm |  |  |   |    |  | <b>00071303</b> |
|       |  |  | 6 | HB |  |                 |
| 58 mm |  |  |   |    |  | <b>00071304</b> |
|       |  |  | 6 | HB |  |                 |
| 62 mm |  |  |   |    |  | <b>00071305</b> |
|       |  |  | 6 | HB |  |                 |
| 67 mm |  |  |   |    |  | <b>00071306</b> |
|       |  |  | 6 | HB |  |                 |
| 72 mm |  |  |   |    |  | <b>00071307</b> |
|       |  |  | 6 | HB |  |                 |
| 77 mm |  |  |   |    |  | <b>00071308</b> |
|       |  |  | 6 | HB |  |                 |

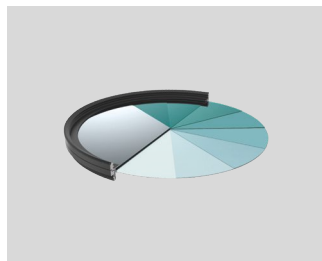
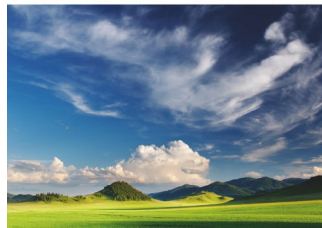

**hama**

**Lens filter**  
"UV Protection Filter Premi-  
um 390, Wide, NSC18 Nano"

|                 |                                   |
|-----------------|-----------------------------------|
| Coating         | NSC18 (Nano Super-Coated 18-fold) |
| Metal Mount     | Black                             |
| Mount Thickness | 2.9 mm                            |
| Type            | UV Protection Filter              |
| Type of Glass   | High-Grade Lens Glass             |

- Block UV rays up to 390 nm
- Especially clear, sharp pictures with brilliant colours since the unwanted blue colouring of ultra-violet radiation is avoided, reducing haze and preventing blurring
- NSC18 coating: nine layers on each side, for excellent permeability to light and maximum anti-reflective properties
- Vapour-deposited nano-coating

|         |  |  |   |    |  |                 |
|---------|--|--|---|----|--|-----------------|
| 40.5 mm |  |  |   |    |  | <b>00071500</b> |
| 46 mm   |  |  |   |    |  | <b>00071501</b> |
|         |  |  | 6 | HB |  |                 |
| 49 mm   |  |  |   |    |  | <b>00071502</b> |
|         |  |  | 6 | HB |  |                 |
| 52 mm   |  |  |   |    |  | <b>00071503</b> |
|         |  |  | 6 | HB |  |                 |
| 55 mm   |  |  |   |    |  | <b>00071504</b> |
|         |  |  | 6 | HB |  |                 |
| 58 mm   |  |  |   |    |  | <b>00071505</b> |
|         |  |  | 6 | HB |  |                 |
| 62 mm   |  |  |   |    |  | <b>00071506</b> |
|         |  |  | 6 | HB |  |                 |
| 67 mm   |  |  |   |    |  | <b>00071507</b> |
|         |  |  | 6 | HB |  |                 |
| 72 mm   |  |  |   |    |  | <b>00071508</b> |
|         |  |  | 6 | HB |  |                 |
| 77 mm   |  |  |   |    |  | <b>00071509</b> |
|         |  |  | 6 | HB |  |                 |
| 82 mm   |  |  |   |    |  | <b>00071510</b> |
|         |  |  | 6 | HB |  |                 |

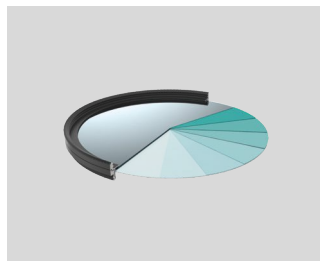

**hama**

**Lens filter**  
"UV Protection Filter Profi  
Line, Wide, NMC 16 Nano"

|                 |                                   |
|-----------------|-----------------------------------|
| Coating         | NMC16 (Nano Multi-Coated 16-fold) |
| Metal Mount     | Black                             |
| Mount Thickness | 2.4 mm                            |
| Type            | UV Protection Filter              |
| Type of Glass   | High-Grade Lens Glass             |

- Clear pictures with brilliant colours since the unwanted blue colouring of ultra-violet radiation is avoided, reducing haze and preventing blurring

|         |  |  |    |    |  |                 |
|---------|--|--|----|----|--|-----------------|
| 37 mm   |  |  |    |    |  | <b>00071400</b> |
| 40.5 mm |  |  |    |    |  | <b>00071401</b> |
| 43 mm   |  |  |    |    |  | <b>00071402</b> |
| 46 mm   |  |  |    |    |  | <b>00071403</b> |
| 49 mm   |  |  |    |    |  | <b>00071404</b> |
|         |  |  | 6  | HB |  |                 |
| 52 mm   |  |  |    |    |  | <b>00071405</b> |
|         |  |  | 6  | HB |  |                 |
| 55 mm   |  |  |    |    |  | <b>00071406</b> |
|         |  |  | 6  | HB |  |                 |
| 58 mm   |  |  |    |    |  | <b>00071407</b> |
|         |  |  | 6  | HB |  |                 |
| 62 mm   |  |  |    |    |  | <b>00071408</b> |
|         |  |  | 6  | HB |  |                 |
| 67 mm   |  |  |    |    |  | <b>00071409</b> |
|         |  |  | 6  | HB |  |                 |
| 72 mm   |  |  |    |    |  | <b>00071410</b> |
|         |  |  | 6  | HB |  |                 |
| 77 mm   |  |  |    |    |  | <b>00071411</b> |
|         |  |  | 6  | HB |  |                 |
| 82 mm   |  |  |    |    |  | <b>00071412</b> |
|         |  |  | 6  | HB |  |                 |
| 95 mm   |  |  |    |    |  | <b>00071413</b> |
|         |  |  | 10 | HB |  |                 |
| 105 mm  |  |  |    |    |  | <b>00071414</b> |
|         |  |  | 10 | HB |  |                 |



**hama**

**Lens filter**  
"UV Protection Filter Profes-  
sional, C-18 Nano, Wide"

|                 |                      |
|-----------------|----------------------|
| Coating         | C18 (18x) NANO       |
| Metal Mount     | Black                |
| Mount Thickness | 3.4 mm               |
| Type            | UV Protection Filter |
| Type of Glass   | Crown Lens Glass     |

- Neutral colour
- C18 coating: nine layers on each side, for very high light transmission
- Nano coating reliably repels water and oil from the filter glass
- Quality standard (glass): crown lens glass
- Specially designed for high-quality lenses
- Flat metal mount, therefore no vignetting (dark shading of picture corners)
- Nevertheless with a front thread for lens caps, other filters or lens hoods

Impact on the pictures:

|       |  |  |   |    |  |                 |
|-------|--|--|---|----|--|-----------------|
| 49 mm |  |  |   |    |  | <b>00104449</b> |
|       |  |  | 6 | HB |  |                 |
| 52 mm |  |  |   |    |  | <b>00104452</b> |
|       |  |  | 6 | HB |  |                 |
| 55 mm |  |  |   |    |  | <b>00104455</b> |
|       |  |  | 6 | HB |  |                 |
| 58 mm |  |  |   |    |  | <b>00104458</b> |
|       |  |  | 6 | HB |  |                 |
| 62 mm |  |  |   |    |  | <b>00104462</b> |
|       |  |  | 6 | HB |  |                 |
| 67 mm |  |  |   |    |  | <b>00104467</b> |
|       |  |  | 6 | HB |  |                 |
| 72 mm |  |  |   |    |  | <b>00104472</b> |
|       |  |  | 6 | HB |  |                 |
| 77 mm |  |  |   |    |  | <b>00104477</b> |
|       |  |  | 6 | HB |  |                 |
| 82 mm |  |  |   |    |  | <b>00104482</b> |
|       |  |  | 6 | HB |  |                 |



**hama**

**Lens filter**  
"UV-Protection Filter 390,  
HTMC-8"

|                 |                       |
|-----------------|-----------------------|
| Coating         | HTMC (8 x)            |
| Metal Mount     | Black                 |
| Mount Thickness | 5 mm                  |
| Type            | UV Protection Filter  |
| Type of Glass   | High-Grade Lens Glass |

- Neutral colour
- HTMC coating: four layers on each side, for high light transmission
- Quality standard (glass): high-quality lens glass

Impact on the pictures:

- Clear, sharp photos
- Absorbs ultraviolet rays up to 390 nm
- Reduces haze and prevents fuzziness

|        |          |
|--------|----------|
| 37 mm  | 00070637 |
| 6 SC   |          |
| 52 mm  | 00070652 |
| 6 BK   |          |
| 55 mm  | 00070655 |
| 6 BK   |          |
| 72 mm  | 00070672 |
| 6 BK   |          |
| 77 mm  | 00070677 |
| 6 SC   |          |
| 86 mm  | 00070686 |
| 6 SC   |          |
| 105 mm | 00070605 |
| 6 BK   |          |



**hama**

**Lens filter**  
"UV-Protection Filter AR-4"

|                 |                       |
|-----------------|-----------------------|
| Coating         | AR Coated             |
| Metal Mount     | Black                 |
| Mount Thickness | 5 mm                  |
| Type            | UV Protection Filter  |
| Type of Glass   | High-Grade Lens Glass |

- Neutral colour
- AR coating: two layers on each side, for better light transmission
- Quality standard (glass): high-quality lens glass

Impact on the pictures:

- Clear, sharp photos
- Reduces haze and prevents fuzziness

|         |          |
|---------|----------|
| 37 mm   | 00070137 |
| 40.5 mm | 00070141 |
| 43 mm   | 00070143 |
| 9 SC    |          |
| 46 mm   | 00070146 |
| 10 SC   |          |
| 49 mm   | 00070149 |
| 9 SC    |          |
| 52 mm   | 00070152 |
| 10 SC   |          |
| 55 mm   | 00070155 |
| 10 SC   |          |
| 58 mm   | 00070158 |
| 10 SC   |          |
| 62 mm   | 00070162 |
| 10 SC   |          |
| 67 mm   | 00070167 |
| 10 SC   |          |
| 72 mm   | 00070172 |
| 10 SC   |          |
| 77 mm   | 00070177 |
| 9 SC    |          |



**hama**

**Lens filter**  
"UV Protection Filter DC  
Double Coated"

|                 |                      |
|-----------------|----------------------|
| Coating         | Coated               |
| Metal Mount     | Black                |
| Mount Thickness | 3.4 mm               |
| Type            | UV Protection Filter |
| Type of Glass   | Optical Glass        |

- Neutral colour
- Coating: one layer on each side
- Quality standard (glass): optical glass

Impact on the pictures:

- Clear, sharp photos
- Reduces haze and prevents fuzziness

|       |          |
|-------|----------|
| 37 mm | 00070037 |
| 49 mm | 00070049 |
| 10 SC |          |
| 52 mm | 00070052 |
| 10 SC |          |
| 55 mm | 00070055 |
| 9 SC  |          |
| 58 mm | 00070058 |
| 10 SC |          |
| 62 mm | 00070062 |
| 10 SC |          |
| 67 mm | 00070067 |
| 10 SC |          |
| 72 mm | 00070072 |
| 10 SC |          |
| 77 mm | 00070077 |
| 10 SC |          |

Adapter Ring



**hama**

**Adapter Ring**  
"For 30 mm Lens"

|                    |       |
|--------------------|-------|
| Shade of colour    | Black |
| Camera/Lens Thread | 30 mm |

- Adapter for all lenses and attachments with screw thread
- Precision metal rings with matt black surface

|       |          |
|-------|----------|
| 37 mm | 00013137 |
| 12 BK |          |



**hama**

**Adapter Ring**  
"For 30.5 mm Lens"

|                    |         |
|--------------------|---------|
| Shade of colour    | Black   |
| Camera/Lens Thread | 30.5 mm |

- Adapter for all lenses and attachments with screw thread
- Precision metal rings with matt black surface

|       |          |
|-------|----------|
| 37 mm | 00013037 |
| 12 BK |          |

# Filter accessories



FILTER & ACCESSORIES



**hama**

**Adapter Ring  
"For 37 mm Lens"**

|                    |       |
|--------------------|-------|
| Shade of colour    | Black |
| Camera/Lens Thread | 37 mm |

- Adapter for all lenses and attachments with screw thread
- Precision metal rings with matt black surface

|       |                 |
|-------|-----------------|
| 37 mm | <b>00013737</b> |
| 43 mm | <b>00013743</b> |
| 46 mm | <b>00013746</b> |
| 52 mm | <b>00013752</b> |
|       | 12 BK           |



**hama**

**Adapter Ring  
"For 46 mm Lens"**

|                    |       |
|--------------------|-------|
| Shade of colour    | Black |
| Camera/Lens Thread | 46 mm |

- Adapter for all lenses and attachments with screw thread
- Precision metal rings with matt black surface

|       |                 |
|-------|-----------------|
| 49 mm | <b>00014649</b> |
| 52 mm | <b>00014652</b> |
| 55 mm | <b>00014655</b> |
| 58 mm | <b>00014658</b> |
|       | 12 BK           |



**hama**

**Adapter Ring  
"For 52 mm Lens"**

|                    |       |
|--------------------|-------|
| Shade of colour    | Black |
| Camera/Lens Thread | 52 mm |

- Adapter for all lenses and attachments with screw thread
- Precision metal rings with matt black surface

|       |                 |
|-------|-----------------|
| 46 mm | <b>00015246</b> |
| 49 mm | <b>00015249</b> |
| 55 mm | <b>00015255</b> |
| 58 mm | <b>00015258</b> |
| 62 mm | <b>00015262</b> |
| 67 mm | <b>00015267</b> |
| 72 mm | <b>00015272</b> |
|       | 12 BK           |



**hama**

**Adapter Ring  
"For 58 mm Lens"**

|                    |       |
|--------------------|-------|
| Shade of colour    | Black |
| Camera/Lens Thread | 58 mm |

- Adapter for all lenses and attachments with screw thread
- Precision metal rings with matt black surface

|       |                 |
|-------|-----------------|
| 49 mm | <b>00015849</b> |
| 52 mm | <b>00015852</b> |
| 55 mm | <b>00015855</b> |
| 62 mm | <b>00015862</b> |
| 67 mm | <b>00015867</b> |
| 72 mm | <b>00015872</b> |
|       | 12 BK           |



**hama**

**Adapter Ring  
"For 43 mm Lens"**

|                    |       |
|--------------------|-------|
| Shade of colour    | Black |
| Camera/Lens Thread | 43 mm |

- Adapter for all lenses and attachments with screw thread
- Precision metal rings with matt black surface

|       |                 |
|-------|-----------------|
| 46 mm | <b>00014346</b> |
| 49 mm | <b>00014349</b> |
| 52 mm | <b>00014352</b> |
|       | 12 BK           |



**hama**

**Adapter Ring  
"For 49 mm Lens"**

|                    |       |
|--------------------|-------|
| Shade of colour    | Black |
| Camera/Lens Thread | 49 mm |

- Adapter for all lenses and attachments with screw thread
- Precision metal rings with matt black surface

|       |                 |
|-------|-----------------|
| 52 mm | <b>00014952</b> |
| 55 mm | <b>00014955</b> |
| 58 mm | <b>00014958</b> |
| 62 mm | <b>00014962</b> |
|       | 12 BK           |



**hama**

**Adapter Ring  
"For 55 mm Lens"**

|                    |       |
|--------------------|-------|
| Shade of colour    | Black |
| Camera/Lens Thread | 55 mm |

- Adapter for all lenses and attachments with screw thread
- Precision metal rings with matt black surface

|       |                 |
|-------|-----------------|
| 52 mm | <b>00015552</b> |
| 58 mm | <b>00015558</b> |
| 62 mm | <b>00015562</b> |
| 72 mm | <b>00015572</b> |
|       | 12 BK           |



**hama**

**Adapter Ring  
"For 62 mm Lens"**

|                    |       |
|--------------------|-------|
| Shade of colour    | Black |
| Camera/Lens Thread | 62 mm |

- Adapter for all lenses and attachments with screw thread
- Precision metal rings with matt black surface

|       |                 |
|-------|-----------------|
| 58 mm | <b>00016258</b> |
| 67 mm | <b>00016267</b> |
| 72 mm | <b>00016272</b> |
|       | 12 BK           |



**hama**

**Adapter Ring  
"For 67 mm Lens"**

|                    |       |
|--------------------|-------|
| Shade of colour    | Black |
| Camera/Lens Thread | 67 mm |

- Adapter for all lenses and attachments with screw thread
- Precision metal rings with matt black surface

|       |                 |
|-------|-----------------|
| 62 mm | <b>00016762</b> |
| 72 mm | <b>00016772</b> |
| 77 mm | <b>00016777</b> |
|       | 12 BK           |



**hama**

**Adapter Ring  
"For 77 mm Lens"**

|                    |       |
|--------------------|-------|
| Shade of colour    | Black |
| Camera/Lens Thread | 77 mm |

- Adapter for all lenses and attachments with screw thread
- Precision metal rings with matt black surface

|       |                 |
|-------|-----------------|
| 72 mm | <b>00017772</b> |
| 82 mm | <b>00017782</b> |
|       | 11 BK           |



**hama**

**Adapter Ring  
"For 72 mm Lens"**

|                    |       |
|--------------------|-------|
| Shade of colour    | Black |
| Camera/Lens Thread | 72 mm |

- Adapter for all lenses and attachments with screw thread
- Precision metal rings with matt black surface

|       |                 |
|-------|-----------------|
| 67 mm | <b>00017267</b> |
| 77 mm | <b>00017277</b> |
|       | 12 BK           |



FILTER & ACCESSORIES





# Accessories for Lenses



# Protection Hoods

Lid



**hama**

Lens Rear Cap for Canon EOS

Shade of colour Black

- Suitable for Canon AF lenses

|          |    |  |
|----------|----|--|
| 00030241 |    |  |
| 11       | BK |  |



**hama**

Lens Rear Cap for Nikon

Shade of colour Black

- Suitable for Nikon lenses

|          |    |  |
|----------|----|--|
| 00030202 |    |  |
| 11       | BK |  |



**hama**

Rear Lens Cap for NEX/Sony

Shade of colour Black

- Suitable for NEX/Sony lenses

|          |    |  |
|----------|----|--|
| 00030246 |    |  |
| 12       | BK |  |



**hama**

Lid  
"Super-Snap"

Shade of colour Black

- Snap function for quick and secure attachment to the filter thread of a lens
- Clamp mechanism integrated in the surface of the lid
- Cannot be removed via the outer edge therefore suitable for secure transportation in bags
- Without any bulky overhang
- Can also be attached to filters

|       |          |    |
|-------|----------|----|
| 37 mm | 00094437 |    |
|       | 12       | BK |



**hama**

Lens Rear Cap for Canon R

Shade of colour Black

- Suitable for Canon R lenses

|          |    |  |
|----------|----|--|
| 00030208 |    |  |
| 12       | BK |  |



**hama**

Nikon Z Lens Rear Cap

Shade of colour Black

- Suitable for Nikon Z lenses

|          |    |  |
|----------|----|--|
| 00030209 |    |  |
| 12       | BK |  |



**hama**

Lid  
"Smart snap, with holder"

Shade of colour Black

- Snap function for quick and secure attachment to the filter thread of a lens
- Retaining cord for securing to a camera and lens
- Internal handle for easy handling- Can also be used with filters- For lenses with 37 mm front filter thread

|       |          |    |
|-------|----------|----|
| 37 mm | 00095400 |    |
|       | 50       | HB |



**hama**

Lid  
"Smart-Snap"

Shade of colour Black

- Snap function for quick and secure attachment to the filter thread of a lens
- Retaining cord for securing to a camera and lens
- Can also be attached to filters

|         |          |    |
|---------|----------|----|
| 40.5 mm | 00095441 |    |
|         | 20       | BK |
| 72 mm   | 00095472 |    |
|         | 20       | BK |

ACCESSORIES FOR LENSES



**hama**

**Lid**  
"Smart snap, with holder"

|                 |       |
|-----------------|-------|
| Shade of colour | Black |
|-----------------|-------|

- Snap function for quick and secure attachment to the filter thread of a lens
- Retaining cord for securing to a camera and lens
- Internal handle for easy handling- Can also be used with filters- For lenses with 40.5 mm front filter thread

|         |          |
|---------|----------|
| 40.5 mm | 00095438 |
| 50      | HB       |



**hama**

**Lid**  
"Smart snap, with holder"

|                 |       |
|-----------------|-------|
| Shade of colour | Black |
|-----------------|-------|

- Snap function for quick and secure attachment to the filter thread of a lens
- Retaining cord for securing to a camera and lens
- Internal handle for easy handling- Can also be used with filters- For lenses with 46 mm front filter thread

|       |          |
|-------|----------|
| 46 mm | 00095447 |
| 50    | HB       |



**hama**

**Lid**  
"Super-Snap"

|                 |       |
|-----------------|-------|
| Shade of colour | Black |
|-----------------|-------|

- Snap function for quick and secure attachment to the filter thread of a lens
- Clamp mechanism integrated in the surface of the lid
- Cannot be removed via the outer edge therefore suitable for secure transportation in bags
- Without any bulky overhang
- Can also be attached to filters

|       |          |
|-------|----------|
| 49 mm | 00094449 |
| 12    | BK       |



**hama**

**Lid**  
"Super-Snap"

|                 |       |
|-----------------|-------|
| Shade of colour | Black |
|-----------------|-------|

- Snap function for quick and secure attachment to the filter thread of a lens
- Clamp mechanism integrated in the surface of the lid
- Cannot be removed via the outer edge therefore suitable for secure transportation in bags
- Without any bulky overhang
- Can also be attached to filters

|       |          |
|-------|----------|
| 52 mm | 00094452 |
| 12    | BK       |



**hama**

**Lid**  
"Smart snap, with holder"

|                 |       |
|-----------------|-------|
| Shade of colour | Black |
|-----------------|-------|

- Snap function for quick and secure attachment to the filter thread of a lens
- Retaining cord for securing to a camera and lens
- Internal handle for easy handling- Can also be used with filters- For lenses with 43 mm front filter thread

|       |          |
|-------|----------|
| 43 mm | 00095442 |
| 50    | HB       |



**hama**

**Lid**  
"Smart snap, with holder"

|                 |       |
|-----------------|-------|
| Shade of colour | Black |
|-----------------|-------|

- Snap function for quick and secure attachment to the filter thread of a lens
- Retaining cord for securing to a camera and lens
- Internal handle for easy handling- Can also be used with filters- For lenses with 49 mm front filter thread

|       |          |
|-------|----------|
| 49 mm | 00095450 |
| 50    | HB       |



**hama**

**Lid**  
"Smart snap, with holder"

|                 |       |
|-----------------|-------|
| Shade of colour | Black |
|-----------------|-------|

- Snap function for quick and secure attachment to the filter thread of a lens
- Retaining cord for securing to a camera and lens
- Large buttons
- Can also be attached to filters

|       |          |
|-------|----------|
| 52 mm | 00095453 |
| 50    | HB       |



**hama**

**Lid**  
"Smart snap, with holder"

|                 |       |
|-----------------|-------|
| Shade of colour | Black |
|-----------------|-------|

- Snap function for quick and secure attachment to the filter thread of a lens
- Retaining cord for securing to a camera and lens
- Large buttons
- Can also be attached to filters

|       |          |
|-------|----------|
| 55 mm | 00095456 |
| 50    | HB       |

ACCESSORIES FOR LENSES

# Protection Hoods



**hama**

Lid  
"Super-Snap"

|                 |       |
|-----------------|-------|
| Shade of colour | Black |
|-----------------|-------|

- Snap function for quick and secure attachment to the filter thread of a lens
- Clamp mechanism integrated in the surface of the lid
- Cannot be removed via the outer edge therefore suitable for secure transportation in bags
- Without any bulky overhang
- Can also be attached to filters

|       |                 |
|-------|-----------------|
| 55 mm | <b>00094455</b> |
|       | 12 BK           |



**hama**

Lid  
"Smart snap, with holder"

|                 |       |
|-----------------|-------|
| Shade of colour | Black |
|-----------------|-------|

- Snap function for quick and secure attachment to the filter thread of a lens
- Retaining cord for securing to a camera and lens
- Internal handle for easy handling- Can also be used with filters- For lenses with 62 mm front filter thread

|       |                 |
|-------|-----------------|
| 62 mm | <b>00095463</b> |
|       | 50 HB           |



**hama**

Lid  
"Super-Snap"

|                 |       |
|-----------------|-------|
| Shade of colour | Black |
|-----------------|-------|

- Snap function for quick and secure attachment to the filter thread of a lens
- Clamp mechanism integrated in the surface of the lid
- Cannot be removed via the outer edge therefore suitable for secure transportation in bags
- Without any bulky overhang
- Can also be attached to filters

|       |                 |
|-------|-----------------|
| 67 mm | <b>00094467</b> |
|       | 12 BK           |



**hama**

Lid  
"Super-Snap"

|                 |       |
|-----------------|-------|
| Shade of colour | Black |
|-----------------|-------|

- Snap function for quick and secure attachment to the filter thread of a lens
- Clamp mechanism integrated in the surface of the lid
- Cannot be removed via the outer edge therefore suitable for secure transportation in bags
- Without any bulky overhang
- Can also be attached to filters

|       |                 |
|-------|-----------------|
| 72 mm | <b>00094472</b> |
|       | 12 BK           |



**hama**

Lid  
"Smart snap, with holder"

|                 |       |
|-----------------|-------|
| Shade of colour | Black |
|-----------------|-------|

- Snap function for quick and secure attachment to the filter thread of a lens
- Retaining cord for securing to a camera and lens
- Internal handle for easy handling- Can also be used with filters- For lenses with 58 mm front filter thread

|       |                 |
|-------|-----------------|
| 58 mm | <b>00095459</b> |
|       | 50 HB           |



**hama**

Lid  
"Smart snap, with holder"

|                 |       |
|-----------------|-------|
| Shade of colour | Black |
|-----------------|-------|

- Snap function for quick and secure attachment to the filter thread of a lens
- Retaining cord for securing to a camera and lens
- Internal handle for easy handling- Can also be used with filters- For lenses with 67 mm front filter thread

|       |                 |
|-------|-----------------|
| 67 mm | <b>00095468</b> |
|       | 50 HB           |



**hama**

Lid  
"Smart snap, with holder"

|                 |       |
|-----------------|-------|
| Shade of colour | Black |
|-----------------|-------|

- Snap function for quick and secure attachment to the filter thread of a lens
- Retaining cord for securing to a camera and lens
- Internal handle for easy handling
- Can also be used with filters
- For lenses with 37 mm front filter thread

|       |                 |
|-------|-----------------|
| 72 mm | <b>00095473</b> |
|       | 50 HB           |



**hama**

Lid  
"Smart snap, with holder"

|                 |       |
|-----------------|-------|
| Shade of colour | Black |
|-----------------|-------|

- Snap function for quick and secure attachment to the filter thread of a lens
- Retaining cord for securing to a camera and lens
- Internal handle for easy handling- Can also be used with filters- For lenses with 77 mm front filter thread

|       |                 |
|-------|-----------------|
| 77 mm | <b>00095478</b> |
|       | 50 HB           |

ACCESSORIES FOR LENSES



**hama**

**Lid**  
"Smart snap, with holder"

|                 |       |
|-----------------|-------|
| Shade of colour | Black |
|-----------------|-------|

- Snap function for quick and secure attachment to the filter thread of a lens
- Retaining cord for securing to a camera and lens
- Internal handle for easy handling- Can also be used with filters- For lenses with 82 mm front filter thread

|       |          |
|-------|----------|
| 82 mm | 00095483 |
| 50 HB |          |

Protection



**hama**

**Lens Cap Holder**

|                 |                          |
|-----------------|--------------------------|
| Shade of colour | Black                    |
| Material        | Plastic Material/ Rubber |

- The elastic band allows attachment to all lens diameters
- The elastic loop stretches around the lens
- The adhesive pad is attached to the lens cap
- For permanently attaching to the lens cap
- The thin elastic loop blends in with the camera's design

|      |          |
|------|----------|
|      | 00005898 |
| 8 BK |          |



**hama**

**Lens Cap Holder**

|                 |        |
|-----------------|--------|
| Shade of colour | Black  |
| Material        | Rubber |

- With a snap hook for attaching to the hand strap's eye
- The adhesive pad is attached to the lens cap
- For permanently attaching to the lens cap

|      |          |
|------|----------|
|      | 00005899 |
| 8 BK |          |

Lens Pouch/Bag



**hama**

**Lens Pouch/Bag**  
"Neoprene", Black

|          |          |
|----------|----------|
| Material | Neoprene |
|----------|----------|

- Snap hook for attachment to camera bag, belt or back pack
- Elastic cord with quick-release buckle for rapid removal of the lens
- Flexible neoprene material for protection against shocks
- Belt loops
- Suitable for lenses with a diameter up to 100 mm and height of up to 170 mm

|        |          |
|--------|----------|
| 50 mm  | 00126693 |
| 10 HC  |          |
| 80 mm  | 00126694 |
| 10 HC  |          |
| 130 mm | 00126695 |
| 10 HC  |          |
| 170 mm | 00126696 |
| 15 HC  |          |

Lens hood



**hama**

**Lens hood**  
"Snap with Lens Cap for Wide Angle Lenses"

|                 |       |
|-----------------|-------|
| Shade of colour | Black |
|-----------------|-------|

- The rotating lens hood blocks light coming in from the side in any desired position
- Snap function for quick and secure attachment of a lens hood and cap to the filter thread of a lens
- For space-saving transport simply put the lens hood on the lens the other way round
- For wide-angle and wide-angle zoom lenses
- Optimized for modern digital lenses
- The matt-finished inner surface avoids reflections
- In addition to the filter, the plastic lens hood provides protection against impacts
- Universally suitable

|       |          |
|-------|----------|
| 77 mm | 00093677 |
| 10 BK |          |
| 67 mm | 00093667 |
| 72 mm | 00093672 |
| 10 BK |          |
| 62 mm | 00093662 |
| 10 BK |          |
| 58 mm | 00093658 |
| 10 BK |          |
| 52 mm | 00093652 |
| 55 mm | 00093655 |
| 10 BK |          |

ACCESSORIES FOR LENSES

# Lens Accessories



ACCESSORIES FOR LENSES



**hama**

## Lens hood "ST for Standard Lenses, foldable"

|                 |       |
|-----------------|-------|
| Shade of colour | Black |
|-----------------|-------|

- Foldable for space-saving transportation
- For standard lenses (from a focal length of 45 mm) and digital cameras with internal thread (screw-in frame: ø72.0 mm)
- Allows you to attach a 72.0 mm filter to the lens hood
- The matte-finished inner surface of the lens hood helps avoid reflections

|         |  |    |    |                 |
|---------|--|----|----|-----------------|
| 72 mm   |  |    |    | <b>00093372</b> |
|         |  | 11 | BK |                 |
| 55 mm   |  |    |    | <b>00093355</b> |
|         |  | 11 | BK |                 |
| 40.5 mm |  |    |    | <b>00093341</b> |
|         |  | 12 | BK |                 |
| 49 mm   |  |    |    | <b>00093349</b> |
|         |  | 10 | BK |                 |



**hama**

## Lens hood "ST for standard lenses, fold- able, New"

|                 |       |
|-----------------|-------|
| Shade of colour | Black |
|-----------------|-------|

- Foldable for space-saving transportation
- For standard lenses (from focal length of 45 mm) and digital cameras with inner thread (screw-in frame: diam. 37.0 mm)
- Allows a 37.0 mm filter to be attached to the lens hood
- Inner surface of the lens hood has a matt finish to prevent reflections

|         |  |    |    |                 |
|---------|--|----|----|-----------------|
| 77 mm   |  |    |    | <b>00093350</b> |
|         |  | 10 | HB |                 |
| 72 mm   |  |    |    | <b>00093347</b> |
|         |  | 10 | HB |                 |
| 67 mm   |  |    |    | <b>00093344</b> |
|         |  | 10 | HB |                 |
| 58 mm   |  |    |    | <b>00093340</b> |
| 62 mm   |  |    |    | <b>00093342</b> |
|         |  | 10 | HB |                 |
| 37 mm   |  |    |    | <b>00093300</b> |
| 40.5 mm |  |    |    | <b>00093303</b> |
| 46 mm   |  |    |    | <b>00093325</b> |
| 49 mm   |  |    |    | <b>00093332</b> |
| 52 mm   |  |    |    | <b>00093336</b> |
|         |  | 10 | HB |                 |
| 55 mm   |  |    |    | <b>00093338</b> |
|         |  | 10 | SC |                 |

# Camera Accessories



# Straps and hand straps

## Carrying Strap

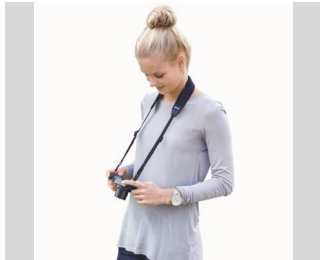

**hama**

"Loop 130" Camera Carrying Strap, neoprene, black

| Material | Plastic Material |
|----------|------------------|
|----------|------------------|

- The strap ends can easily and quickly be removed on the quick-release fastener
- Superior carrying comfort due to the elastic strap
- Especially durable thanks to super-elastic neoprene
- Adjustable length: 70 - 130 cm

|       |      |                 |
|-------|------|-----------------|
| Black |      | <b>00027210</b> |
|       | 6 BK |                 |

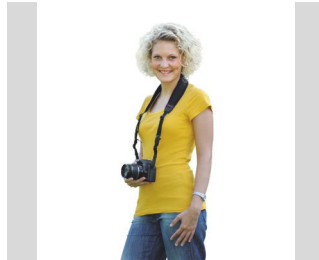

**hama**

"2in1 130" Camera Carrying Strap, neoprene, ergonomic, black

| Material       | Neoprene |
|----------------|----------|
| Maximum Length | 130 cm   |

- The ends of the strap are removable at the quick release fastener and function as a separate carrying loop for a camera
- The elastic and ergonomically shaped strap provides superior carrying comfort
- Especially durable thanks to super elastic neoprene
- Bottom side with a rubber-coated, non-slip structure
- With a round split ring, especially suited for fixing to older camera models
- Adjustable length: 100 - 130 cm

|       |      |                 |
|-------|------|-----------------|
| Black |      | <b>00027204</b> |
|       | 6 BK |                 |

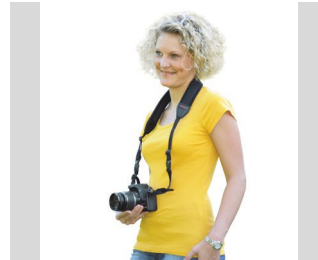

**hama**

"2in1 130" Camera Carrying Strap, neoprene, straight, black

| Material       | Neoprene |
|----------------|----------|
| Maximum Length | 130 cm   |

- The ends of the strap are removable at the quick release fastener and function as a separate carrying loop for a camera
- Straight strap, especially durable thanks to super elastic neoprene
- Bottom side with a rubber-coated, non-slip structure
- With a round split ring, especially suited for fixing to older camera models
- Adjustable length: 90 - 130 cm

|       |      |                 |
|-------|------|-----------------|
| Black |      | <b>00027202</b> |
|       | 6 BK |                 |



**hama**

"Air Comfort 140" Camera Carrying Strap, neoprene, black

| Material       | Neoprene |
|----------------|----------|
| Maximum Length | 140 cm   |

- The 12 air cushions (patented air cell technology) provide superior carrying comfort as they take on a form perfectly matched to the wearer's nape
- Super elastic neoprene material
- Especially durable
- Loop clasp system
- Adjustable length: 70 - 140 cm

|       |      |                 |
|-------|------|-----------------|
| Black |      | <b>00027200</b> |
|       | 6 BK |                 |

CAMERA ACCESSORIES







**hama**

"Braid 120" Camera Strap,  
Quick Fastener, Length  
120 cm, black

|                |        |
|----------------|--------|
| Material       | Nylon  |
| Maximum Length | 120 cm |

- Snow, rain or sun: weather-resistant nylon is suitable for all weathers
- Retro design in trendy woven look
- Elastic camera strap made from tear-resistant nylon is pleasant to carry
- Can be used for all cameras with eyelets
- Simply separate the camera from the strap via the quick fastener

|       |  |    |    |  |  |                 |
|-------|--|----|----|--|--|-----------------|
| Black |  |    |    |  |  | <b>00027212</b> |
|       |  | 50 | HB |  |  |                 |



**hama**

"Braid 120" Camera Strap,  
Quick Fastener, Length  
120 cm, black/yellow

|                |        |
|----------------|--------|
| Material       | Nylon  |
| Maximum Length | 120 cm |

- Snow, rain or sun: weather-resistant nylon is suitable for all weathers
- Retro design in trendy woven look
- Elastic camera strap made from tear-resistant nylon is pleasant to carry
- Can be used for all cameras with eyelets
- Simply separate the camera from the strap via the quick fastener

|               |  |    |    |  |  |                 |
|---------------|--|----|----|--|--|-----------------|
| Black, Yellow |  |    |    |  |  | <b>00027213</b> |
|               |  | 50 | HB |  |  |                 |



**hama**

"Braid 120" Camera Strap,  
Quick Fastener, Length  
120 cm, orange/blue

|                |        |
|----------------|--------|
| Material       | Nylon  |
| Maximum Length | 120 cm |

- Snow, rain or sun: weather-resistant nylon is suitable for all weathers
- Retro design in trendy woven look
- Elastic camera strap made from tear-resistant nylon is pleasant to carry
- Can be used for all cameras with eyelets
- Simply separate the camera from the strap via the quick fastener

|              |  |    |    |  |  |                 |
|--------------|--|----|----|--|--|-----------------|
| Blue, Orange |  |    |    |  |  | <b>00027214</b> |
|              |  | 50 | HB |  |  |                 |

Hand Strap



**hama**

"Pro II" Hand Strap

|          |                                |
|----------|--------------------------------|
| Material | Faux Leather, Plastic Material |
|----------|--------------------------------|

- The 9 air cushions (patented air cell technology) in the hand strap provide superior carrying comfort as they take on a form perfectly matched to the wearer's hand
- A mounting plate adapts the tripod mount so that the tripod can still be used without having to unscrew the plate
- Universally usable for cameras with a B1/4" (6.4 mm) tripod mount and strap attachment

|       |  |   |    |  |  |                 |
|-------|--|---|----|--|--|-----------------|
| Black |  |   |    |  |  | <b>00027501</b> |
|       |  | 6 | BK |  |  |                 |



**hama**

Hand Strap, fabric, 22 cm,  
black

|          |                  |
|----------|------------------|
| Material | Plastic Material |
|----------|------------------|

- Usable for all compact cameras, also suitable for MP3 players, USB sticks, etc. with an eyelet
- Tearproof and robust woven structure
- Adjustable for an optimal hold around your hand and wrist

|       |  |   |    |  |  |                 |
|-------|--|---|----|--|--|-----------------|
| Black |  |   |    |  |  | <b>00027812</b> |
|       |  | 6 | BK |  |  |                 |



CAMERA ACCESSORIES

# Straps and hand straps



**hama**

**Handle Loop, Textile, 22 cm, black**

|          |                  |
|----------|------------------|
| Material | Plastic Material |
|----------|------------------|

- Can be used universally for all compact cameras, also suitable for MP3 players, USB sticks, etc. with eyelet
- Tear-resistant and robust woven structure
- Adjustable for optimised grip at the hand and wrist

|       |          |
|-------|----------|
| Black | 00027836 |
|       | 8 HB     |



**hama**

**Carrying Loop with Quick Fastener, 45 cm, black**

|          |       |
|----------|-------|
| Material | Nylon |
|----------|-------|

- Can be used universally for all compact cameras, also suitable for MP3 players, USB sticks, etc. with eyelet
- 2-piece: separate the camera from the strap via the quick fastener
- Tear-resistant and robust woven structure

|       |          |
|-------|----------|
| Black | 00027838 |
|       | 8 HB     |

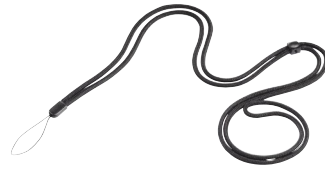

**hama**

**Hand Strap, fabric, 65 cm, black**

|          |       |
|----------|-------|
| Material | Nylon |
|----------|-------|

- Usable for all compact cameras, also suitable for MP3 players, USB sticks, etc. with an eyelet
- Tearproof and sturdy weave

|       |          |
|-------|----------|
| Black | 00027819 |
|       | 6 BK     |

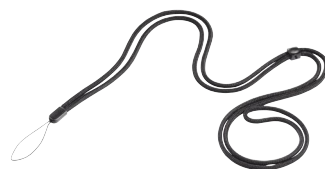

**hama**

**Handle Loop, Textile, 65 cm, black**

|          |       |
|----------|-------|
| Material | Nylon |
|----------|-------|

- Can be used universally for all compact cameras, also suitable for MP3 players, USB sticks, etc. with eyelet
- Tear-resistant and robust woven structure

|       |          |
|-------|----------|
| Black | 00027837 |
|       | 8 HB     |



**hama**

**Hand Strap "Braid 20, quick release, length 20 cm"**

|          |           |
|----------|-----------|
| Material | Polyester |
|----------|-----------|

- Snow, rain or sun: weather-resistant polyester is suitable for all weathers
- Retro design in trendy woven look
- Made from very lightweight and soft polyester, therefore pleasant to carry
- Can be used for all cameras with eyelets
- The camera can be easily separated from the strap via the quick fastener

|               |          |
|---------------|----------|
| Black, Orange | 00027217 |
| Black         | 00027215 |
| Black, Yellow | 00027216 |
|               | 50 HB    |

Split Ring



**hama**

**Split Rings, square, 6 pieces**

- Triangular shape, especially suited for fixing to older camera models

|  |          |
|--|----------|
|  | 00027902 |
|  | 8 BK     |

CAMERA ACCESSORIES

# Protective Films/Glasses | Protection Hoods

## Screen Protector



**hama**

"Premium" EASY-ON®  
Universal Screen Protector,  
displays up to 14 cm (5.5")

- Extremely scratch-resistant, acid-proof, antistatic and washable screen protector with 4-layer technology
- True colour reproduction on the display ensures brilliant colours
- EASY-ON®: fixing aids for easy attachment of the protective film
- Universal fit for all digital cameras, mobile phones, MP3 players and navigation systems with a screen size of up to 14 cm (5.5")

|          |    |  |
|----------|----|--|
| 00001210 |    |  |
| 25       | HC |  |



**hama**

"Premium" EASY-ON®  
Universal Screen Protectors,  
displays up to 7.62cm (3.0")

- Extremely scratch-resistant, acid-proof, antistatic and washable screen protector with 4-layer technology
- True colour reproduction on the display ensures brilliant colours
- Precision laser cut for a perfect fit and contour precision
- EASY-ON®: fixing aids for easy attachment of the protective film
- Universal fit for all digital cameras, mobile phones, MP3 players and navigation systems

|          |    |  |
|----------|----|--|
| 00001211 |    |  |
| 25       | HC |  |

## Lid\*



**hama**

Body Cap for Canon EOS

|                 |       |
|-----------------|-------|
| Shade of colour | Black |
|-----------------|-------|

- Suitable for Canon EOS DSLR cameras

|          |    |  |
|----------|----|--|
| 00030145 |    |  |
| 12       | BK |  |



**hama**

Housing Cover for Canon R

|                 |       |
|-----------------|-------|
| Shade of colour | Black |
|-----------------|-------|

- Suitable for Canon R DSLR cameras

|          |    |  |
|----------|----|--|
| 00030139 |    |  |
| 12       | BK |  |



**hama**

Body Cap for Nikon

|                 |       |
|-----------------|-------|
| Shade of colour | Black |
|-----------------|-------|

- Suitable for all Nikon SLR and DSLR cameras

|          |    |  |
|----------|----|--|
| 00030102 |    |  |
| 12       | BK |  |



**hama**

Body Cap for Canon EOS M

|                 |       |
|-----------------|-------|
| Shade of colour | Black |
|-----------------|-------|

- Suitable for Canon EOS M DSLR cameras

|          |    |  |
|----------|----|--|
| 00030138 |    |  |
| 12       | BK |  |



**hama**

Body Cap for NEX/Sony

|                 |       |
|-----------------|-------|
| Shade of colour | Black |
|-----------------|-------|

- Suitable for NEX/Sony DSLR cameras

|          |    |  |
|----------|----|--|
| 00030140 |    |  |
| 12       | BK |  |



**hama**

Housing Cover for Nikon Z

|                 |       |
|-----------------|-------|
| Shade of colour | Black |
|-----------------|-------|

- Suitable for all Nikon Z cameras

|          |    |  |
|----------|----|--|
| 00030141 |    |  |
| 12       | BK |  |

## Release



**hama**

"Professional" Wire Release,  
40 cm

|                 |       |
|-----------------|-------|
| Shade of colour | Black |
| Length          | 40 cm |

- Bulb function for shake-free long-term exposures
- Easy to place in position by means of the lock, ideal for time exposures (bulb)
- Ergonomically shaped handle allows easy release

|          |    |  |
|----------|----|--|
| 00005312 |    |  |
| 6        | BK |  |

## HDMI™-Cable



**hama**

HDMI™-Cable  
"High Speed Type A/A +  
2 Adapters", Black

|                    |                          |
|--------------------|--------------------------|
| Data Transfer Rate | 18 Gbit/s                |
| Max. Resolution    | 4k (4096 x 2160)         |
| Version            | High Speed with Ethernet |

- 3in1 connection for connecting every camera to a TV and a PC/notebook to a TV
- Gold-plated plug with low contact resistance for secure signal transmission
- Integrated channel for transmitting network data with up to 100 Mbit/s
- 3D transmission due to extended bandwidth
- Fully shielded audio and video lines for optimum reduction of electromagnetic interference
- Return of the audio signal without additional audio cable (ODT, RCA etc.)
- HDMI™ cable for perfect, high-resolution ultra HD cinema quality 4096x2160 (4k) pixels
- Image resolution: 3840 x 2160 - 24 Hz/25 Hz/30 Hz/50 Hz/60Hz, 4096 x 2160 - 24 Hz
- Colour space: 30/36/48 bit
- Transmission of the following audio data: 8PCM, Dolby Digital, DTS, MPEG, DVD-Audio, SACD, Dolby Digital Plus, True HD, dts-HD
- Transmission of the type of player via ACE (Automatic Content Enhancement)
- HDMI™ CEC support (Consumer Electronics Control)
- High speed transmission of up to 18 Gbit/s for all image and sound standards from a bandwidth of 600 MHz
- HDMI™ adapter for connecting an HDMI™ Type A cable to devices with HDMI™ type C (mini) socket / HDMI™ type D (micro) socket

|       |          |  |
|-------|----------|--|
| 1.5 m | 00074242 |  |
| 6     | BK       |  |

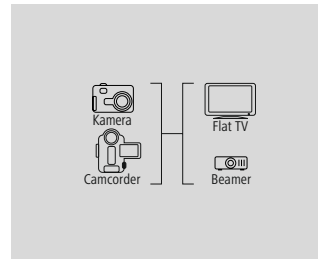

**hama**

HDMI™-Cable  
"High Speed Type A/C (Mini)",  
Black

|                    |                          |
|--------------------|--------------------------|
| Data Transfer Rate | 18 Gbit/s                |
| Max. Resolution    | 4k (4096 x 2160)         |
| Version            | High Speed with Ethernet |

- Gold-plated plugs with low contact resistance for secure signal transmission
- Fully shielded audio and video lines for optimum reduction of electromagnetic interference
- Integrated channel for transmitting network data with up to 100 Mbit/s
- 3D transmission due to extended bandwidth
- Return of the audio signal without additional audio cable (ODT, RCA etc.)
- Supports automatic video/audio synchronization of HDMI™ devices
- Colour resolution: 3840 x 2160 - 24 Hz/25 Hz/30 Hz/50 Hz/60 Hz, 4096 x 2160 - 24 Hz
- Transmission of the following audio data: 8PCM, Dolby Digital, DTS, MPEG, DVD-Audio, SACD, Dolby Digital Plus, True HD, dts-HD
- High-speed transmission of up to 18 Gbit/s for all image and sound standards with a bandwidth of 600 MHz and more
- Extended colour space

|       |          |  |
|-------|----------|--|
| 0.5 m | 00074237 |  |
| 6     | BK       |  |
| 2 m   | 00074229 |  |
| 6     | BK       |  |

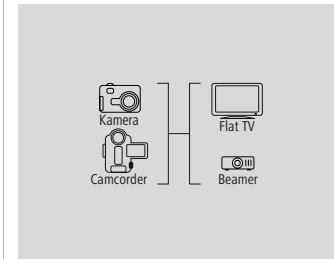

**hama**

HDMI™-Cable  
"High Speed Type A/D  
(Micro)", Black

|                    |                          |
|--------------------|--------------------------|
| Data Transfer Rate | 18 Gbit/s                |
| Max. Resolution    | 4k (4096 x 2160)         |
| Version            | High Speed with Ethernet |

- HDMI™ cable for perfect, high-resolution ultra HD cinema quality 4096x2160 (4k) pixels
- Gold-plated plugs with low contact resistance for secure signal transmission
- Fully shielded audio and video lines for optimum reduction of electromagnetic interference
- Integrated channel for transmitting network data with up to 100 Mbit/s
- 3D transmission due to extended bandwidth
- Return of the audio signal without additional audio cable (ODT, RCA etc.)
- For connecting devices with HDMI™ type A connection to devices with HDMI™ type D (micro) socket
- Image resolution: 3840 x 2160 - 24 Hz/25 Hz/30 Hz/50 Hz/60Hz, 4096 x 2160 - 24 Hz
- Colour space: 30/36/48 bits
- Transmission of the following audio data: 8PCM, Dolby Digital, DTS, MPEG, DVD-Audio, SACD, Dolby Digital Plus, True HD, dts-HD
- Transmission of the type of player via ACE (Automatic Content Enhancement)
- HDMI™ CEC support (Consumer Electronics Control)
- High-speed transmission of up to 18 Gbit/s for all image and sound standards with a bandwidth of 600 MHz and more

|       |          |  |
|-------|----------|--|
| 0.5 m | 00074239 |  |
| 6     | BK       |  |
| 2 m   | 00074240 |  |
| 6     | BK       |  |

CAMERA ACCESSORIES

## USB Cable

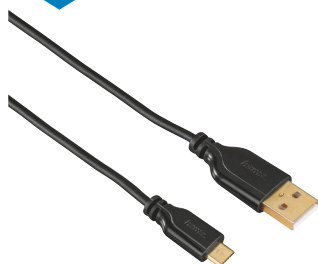

**hama**

### USB Cable "Micro USB 2.0 Cable, Gold-Plated, Twist-Proof", Black

| Connection   | Micro-USB-Plug, USB Micro B Plug, USB-Typ-A-Plug |
|--------------|--|
| USB Standard | USB 2.0  |

- High-speed data transfer of up to 480 Mbps
- Gold-plated plug with low contact resistance for secure signal transmission
- The inner conductor is made of copper which ensures best transmission properties
- Light and space-saving due to the ultra thin, flexible cable and the extra small plugs
- Slim design especially suited for portable devices like smartphones, tablets and cameras
- No bothersome trying out: the plug can be inserted without having to be turned
- Sturdy plugs and moulded strain reliefs, high mechanical resistance
- Twisted data lines (twisted pairs)
- Ideal for charging, data transfer and synchronization
- Also called "reversible micro USB"

|        |          |
|--------|----------|
| 0.75 m | 00074251 |
| 12     | BK       |



**hama**

### USB Cable "Micro, with LED indicator", Black

| Connection   | Micro-USB-Plug |
|--------------|----------------|
| USB Standard | USB 2.0        |

- Sturdy plugs and moulded strain reliefs, high mechanical resistance
- LED function indicator gives information about the charge state
- Red LED display: during charging / green LED display: when almost fully charged

|     |          |
|-----|----------|
| 1 m | 00074254 |
| 12  | BK       |

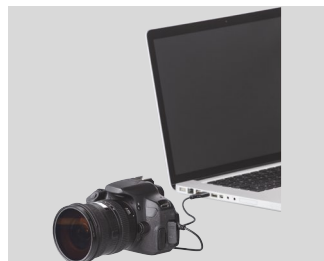

**hama**

### USB Cable "2.0 Type A/Mini B (B5 Pin)", Black

| Connection   | USB Mini B Plug, USB-Typ-A-Plug |
|--------------|---------------------------------|
| USB Standard | USB 2.0                         |

- High-speed data transfer of up to 480 Mbps
- Gold-plated plugs with low contact resistance for secure signal transmission
- Light and space-saving due to the ultra thin, flexible cable and the extra small plugs
- Slim design especially suited for portable devices like smartphones, tablets and cameras
- The inner conductor is made of copper which ensures best transmission properties
- USB 2.0 (downward compatible)
- Sturdy plugs and moulded strain reliefs, high mechanical resistance
- Twisted data lines (twisted pairs)
- Ideal for data transfer and synchronization

|        |          |
|--------|----------|
| 0.75 m | 00074248 |
| 12     | BK       |



**hama**

### USB Cable "2.0 Type A/Mini B (B8 Pin)", Black

| Connection   | USB Mini B Plug, USB-Typ-A-Plug |
|--------------|---------------------------------|
| USB Standard | USB 2.0                         |

- High-speed data transfer of up to 480 Mbps
- Gold-plated plugs with low contact resistance for secure signal transmission
- Light and space-saving due to the ultra thin, flexible cable and the extra small plugs
- Slim design especially suited for portable devices like smartphones, tablets and cameras
- The inner conductor is made of copper which ensures best transmission properties
- USB 2.0 (downward compatible)
- Sturdy plugs and moulded strain reliefs, high mechanical resistance
- Twisted data lines (twisted pairs)
- Ideal for data transfer and synchronization

|        |          |
|--------|----------|
| 0.75 m | 00074249 |
| 12     | BK       |

# Cables & Adapters

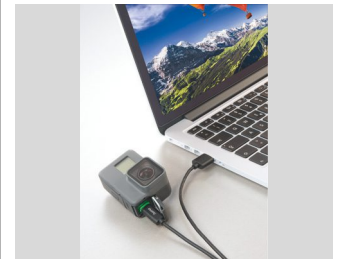
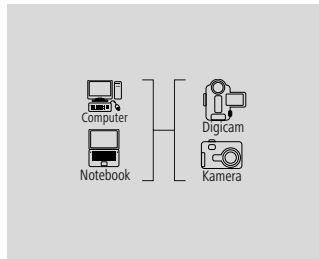

CAMERA ACCESSORIES

**hama**

**USB Cable  
"Flexi-Slim, USB-A - USB-C,  
USB 2.0, 480 Mbps", Black**

| Connection   | USB-C-plug, USB-Typ-A-Plug |
|--------------|----------------------------|
| USB Standard | USB 2.0                    |

- High-speed data transfer of up to 480 Mbps
- Light and space-saving due to the ultra thin, flexible cable and the extra small plugs
- Gold-plated plug with low contact resistance for secure signal transmission
- Flexible materials guarantee optimum kink protection and prevent cable breakage
- High-quality materials and workmanship guarantee excellent transmission quality
- Twisted data pairs with an outer sheath made from robust PVC material minimise interference
- Internal wires made from copper for rapid data transfer and the best supply of power
- Ideal for charging, transferring data and synchronising
- also as a replacement for the original cable if it is too short, long or faulty

|        |                 |
|--------|-----------------|
| 0.75 m | <b>00074265</b> |
| 12 BK  |                 |

**hama**

**USB Cable  
"2.0 Type A/Mini B (B5 Pin)",  
Black**

| Connection   | USB Mini B Plug, USB-Typ-A-Plug |
|--------------|---------------------------------|
| USB Standard | USB 2.0                         |

- USB 2.0 (downward compatible)
- High-density shielding due to tinned copper strands, fully excludes disturbing radiation/emittance

|       |                 |
|-------|-----------------|
| 1.8 m | <b>00074201</b> |
| 6 BK  |                 |

**hama**

**USB Cable  
"2.0 Type A/Mini B (B8 Pin)",  
Black**

| Connection   | USB Mini B Plug, USB-Typ-A-Plug |
|--------------|---------------------------------|
| USB Standard | USB 2.0                         |

- High-speed data transfer of up to 480 Mbps
- USB 2.0 (downward compatible)
- High-density shielding due to tinned copper strands, fully excludes disturbing radiation/emittance

|       |                 |
|-------|-----------------|
| 1.8 m | <b>00074204</b> |
| 6 BK  |                 |

**hama**

**USB Cable  
"Type-C, with LED indicator",  
Black**

| Connection   | USB-C-plug |
|--------------|------------|
| USB Standard | USB 2.0    |

- Sturdy plugs and moulded strain reliefs, high mechanical resistance
- LED function indicator gives information about the charge state
- Red LED display: during charging / green LED display: when almost fully charged

|       |                 |
|-------|-----------------|
| 1 m   | <b>00074255</b> |
| 12 BK |                 |

## Video Converter



**hama**

**Video Recording Stick, USB Plug - HDMI™ Socket, 4K**

|            |                              |
|------------|------------------------------|
| Connection | HDMI™ Socket, USB-Typ-A-Plug |
|------------|------------------------------|

- Fluid video recordings without delays or distortions during live streaming thanks to a picture frequency of 60 Hz and 1080p with Full HD
- Transform high-quality video cameras into a high-resolution USB web camera and use it in various apps without additional software
- High-quality and sturdy aluminium housing in a sophisticated design

|  |   |    |  |                 |
|--|---|----|--|-----------------|
|  |   |    |  | <b>00074257</b> |
|  | 6 | HB |  |                 |

## Microphone



**hama**

**"RMN Uni" Directional Microphone, for Accessory Shoe**

|              |                  |
|--------------|------------------|
| Connection   | 3.5 mm Jack Plug |
| Directivity  | Uni-directional  |
| Model        | Mono             |
| Cable Length | 0.32 m           |

- From smartphones to camcorders - for bloggers or film-makers: the microphone is ideal for all devices
- The vibration-attenuating anti-shock frame absorbs mechanical vibration and noise
- Passive, dynamic directional microphone

|       |    |    |  |                 |
|-------|----|----|--|-----------------|
| Black |    |    |  | <b>00004647</b> |
|       | 10 | HB |  |                 |



**hama**

**"Smart" Lavalier Microphone**

|              |                  |
|--------------|------------------|
| Connection   | 3.5 mm Jack Plug |
| Directivity  | omni-directional |
| Model        | Mono             |
| Cable Length | 6 m              |

- From smartphones to camcorders - for bloggers or film-makers: the microphone is ideal for all devices
- 6 metres for plenty of room to manoeuvre: reporters, vloggers and influencers therefore have plenty of freedom for their voice and video recordings

|       |   |    |  |                 |
|-------|---|----|--|-----------------|
| Black |   |    |  | <b>00004634</b> |
|       | 6 | HB |  |                 |

## Camera Lens Adapter



**hama**

**Lens Adapter for Cameras with T2 Connection and Canon EOS Lenses**

|       |    |    |  |                 |
|-------|----|----|--|-----------------|
| Black |    |    |  | <b>00030743</b> |
|       | 11 | BK |  |                 |



**hama**

**Lens Adapter for Cameras with C-Mount Connection to Nikon Lenses**

|       |   |    |  |                 |
|-------|---|----|--|-----------------|
| Black |   |    |  | <b>00030770</b> |
|       | 6 | BK |  |                 |

## Spirit Level



**hama**

**Camera Spirit Level, 2 bubble levels**

|                         |   |
|-------------------------|---|
| Number of Bubble Levels | 2 |
|-------------------------|---|

- For adjusting the camera for portrait and landscape shots
- Transparent housing
- Is inserted into the camera's hot shoe (standard flash shoe), can also be connected via a flash bracket
- 2 feet to position the camera for upright and broadside shots
- 2 bubble levels for precise adjustment

|  |   |    |  |                 |
|--|---|----|--|-----------------|
|  |   |    |  | <b>00005411</b> |
|  | 6 | BK |  |                 |





# Energy



# Rechargeable Batteries & Powerpacks

Replacement battery



**hama**

"CP 826" Lithium Ion Battery for Canon BP-511

|          |          |
|----------|----------|
| Capacity | 1400 mAh |
| Voltage  | 7.4 V    |
| Model    | Li-Ion   |

- Use with UL/IEC-certified branded cells: for increased safety
- Safety electronics: for monitoring of the charging and discharge process
- Gold-plated contacts: for fewer contact losses and prevention of corrosion
- Self-resetting thermal fuse (Polyswitch/PTC): additional protection against short circuits and overload

|   |    |                 |
|---|----|-----------------|
|   |    | <b>00077531</b> |
| 6 | HB |                 |



**hama**

"DP 342" Lithium Ion Battery for Canon LP-E5

|          |         |
|----------|---------|
| Capacity | 700 mAh |
| Voltage  | 7.4 V   |
| Model    | Li-Ion  |

- Use with UL/IEC-certified branded cells: for increased safety
- Safety electronics: for monitoring of the charging and discharge process
- Gold-plated contacts: for fewer contact losses and prevention of corrosion
- Self-resetting thermal fuse (Polyswitch/PTC): additional protection against short circuits and overload

|   |    |                 |
|---|----|-----------------|
|   |    | <b>00077526</b> |
| 6 | HB |                 |



**hama**

"DP 384" Lithium Ion Battery for Canon LP-E8

|                 |         |
|-----------------|---------|
| Shade of colour | Black   |
| Capacity        | 950 mAh |
| Voltage         | 7.4 V   |
| Model           | Li-Ion  |

- Use with UL/IEC-certified branded cells: for increased safety
- Safety electronics: for monitoring of the charging and discharge process
- Gold-plated contacts: for fewer contact losses and prevention of corrosion
- Self-resetting thermal fuse (Polyswitch/PTC): additional protection against short circuits and overload

|   |    |                 |
|---|----|-----------------|
|   |    | <b>00077527</b> |
| 6 | HB |                 |



**hama**

"DP 543" Lithium Ion Battery for Canon LP-E12

|                 |         |
|-----------------|---------|
| Shade of colour | Black   |
| Capacity        | 700 mAh |
| Voltage         | 7.2 V   |
| Model           | Li-Ion  |

- Use with UL/IEC-certified branded cells: for increased safety
- Safety electronics: for monitoring of the charging and discharge process
- Gold-plated contacts: for fewer contact losses and prevention of corrosion
- Fixation of the cells thanks to super-adhesive tape: for improved resistance to impacts and mechanical protection

|   |    |                 |
|---|----|-----------------|
|   |    | <b>00077543</b> |
| 6 | HB |                 |



**hama**

"DP 544" Lithium Ion Battery for Canon LP-E5

|          |         |
|----------|---------|
| Capacity | 800 mAh |
| Voltage  | 7.4 V   |
| Model    | Li-Ion  |

- Use with UL/IEC-certified branded cells: for increased safety
- Safety electronics: for monitoring of the charging and discharge process
- Gold-plated contacts: for fewer contact losses and prevention of corrosion
- Self-resetting thermal fuse (Polyswitch/PTC): additional protection against short circuits and overload

|   |    |                 |
|---|----|-----------------|
|   |    | <b>00077544</b> |
| 6 | HB |                 |



**hama**

"DP 553" Lithium Ion Battery for Canon LP-E6

|                 |          |
|-----------------|----------|
| Shade of colour | Black    |
| Capacity        | 1500 mAh |
| Voltage         | 7.2 V    |
| Model           | Li-Ion   |

- Use with UL/IEC-certified branded cells: for increased safety
- Safety electronics: for monitoring of the charging and discharge process
- Gold-plated contacts: for fewer contact losses and prevention of corrosion
- Self-resetting thermal fuse (Polyswitch/PTC): additional protection against short circuits and overload

|   |    |                 |
|---|----|-----------------|
|   |    | <b>00077553</b> |
| 6 | HB |                 |



**hama**

"DP 396" Lithium Ion Battery for Canon LP-E10

|                 |         |
|-----------------|---------|
| Shade of colour | Black   |
| Capacity        | 950 mAh |
| Voltage         | 7.4 V   |
| Model           | Li-Ion  |

- Use with UL/IEC-certified branded cells: for increased safety
- Safety electronics: for monitoring of the charging and discharge process
- Gold-plated contacts: for fewer contact losses and prevention of corrosion
- Self-resetting thermal fuse (Polyswitch/PTC): additional protection against short circuits and overload

|   |    |                 |
|---|----|-----------------|
|   |    | <b>00077511</b> |
| 6 | HB |                 |



**hama**

"DP 219" Li-Ion Battery for Canon NB-2L/H

|          |         |
|----------|---------|
| Capacity | 700 mAh |
| Voltage  | 7.4 V   |
| Model    | Li-Ion  |

- Use with UL/IEC-certified branded cells: for increased safety
- Safety electronics: for monitoring of the charging and discharge process
- Gold-plated contacts: for fewer contact losses and prevention of corrosion
- Self-resetting thermal fuse (Polyswitch/PTC): additional protection against short circuits and overload

|   |    |                 |
|---|----|-----------------|
|   |    | <b>00077529</b> |
| 6 | HB |                 |

ENERGY



# Rechargeable Batteries & Powerpacks



**hama**

"DP 546" Lithium Ion Battery for Canon NB-6L

|                 |         |
|-----------------|---------|
| Shade of colour | Black   |
| Capacity        | 675 mAh |
| Voltage         | 3.7 V   |
| Model           | Li-Ion  |

- Use with UL/IEC-certified branded cells: for increased safety
- Safety electronics: for monitoring of the charging and discharge process
- Gold-plated contacts: for fewer contact losses and prevention of corrosion
- Self-resetting thermal fuse (Polyswitch/PTC): additional protection against short circuits and overload

|          |    |  |
|----------|----|--|
| 00077546 |    |  |
| 6        | HB |  |



**hama**

"DP 321" Lithium Ion Battery for Nikon EN-EL3e

|          |          |
|----------|----------|
| Capacity | 1500 mAh |
| Voltage  | 7.4 V    |
| Model    | Li-Ion   |

- Use with UL/IEC-certified branded cells: for increased safety
- Safety electronics: for monitoring of the charging and discharge process
- Gold-plated contacts: for fewer contact losses and prevention of corrosion
- Self-resetting thermal fuse (Polyswitch/PTC): additional protection against short circuits and overload

|          |    |  |
|----------|----|--|
| 00077525 |    |  |
| 6        | HB |  |



**hama**

"DP 548" Lithium Ion Battery for Nikon EN-EL12

|                 |         |
|-----------------|---------|
| Shade of colour | Black   |
| Capacity        | 970 mAh |
| Voltage         | 3.7 V   |
| Model           | Li-Ion  |

- Use with UL/IEC-certified branded cells: for increased safety
- Safety electronics: for monitoring of the charging and discharge process
- Gold-plated contacts: for fewer contact losses and prevention of corrosion
- Self-resetting thermal fuse (Polyswitch/PTC): additional protection against short circuits and overload

|          |    |  |
|----------|----|--|
| 00077548 |    |  |
| 6        | HB |  |



**hama**

"DP 550" Li-Ion Battery for Olympus Li42B

|                 |         |
|-----------------|---------|
| Shade of colour | Black   |
| Capacity        | 675 mAh |
| Voltage         | 3.7 V   |
| Model           | Li-Ion  |

- Use with UL/IEC-certified branded cells: for increased safety
- Safety electronics: for monitoring of the charging and discharge process
- Gold-plated contacts: for fewer contact losses and prevention of corrosion
- Self-resetting thermal fuse (Polyswitch/PTC): additional protection against short circuits and overload

|          |    |  |
|----------|----|--|
| 00077550 |    |  |
| 6        | HB |  |



**hama**

"DP 437" Lithium Ion Battery for Canon NB-11L

|                 |         |
|-----------------|---------|
| Shade of colour | Black   |
| Capacity        | 580 mAh |
| Voltage         | 3.6 V   |
| Model           | Li-Ion  |

- Use with UL/IEC-certified branded cells: for increased safety
- Safety electronics: for monitoring of the charging and discharge process
- Gold-plated contacts: for fewer contact losses and prevention of corrosion
- Self-resetting thermal fuse (Polyswitch/PTC): additional protection against short circuits and overload

|          |    |  |
|----------|----|--|
| 00077520 |    |  |
| 6        | HB |  |



**hama**

"DP 323" Lithium Ion Battery for Nikon EN-EL9

|          |         |
|----------|---------|
| Capacity | 900 mAh |
| Voltage  | 7.4 V   |
| Model    | Li-Ion  |

- Use with UL/IEC-certified branded cells: for increased safety
- Safety electronics: for monitoring of the charging and discharge process
- Self-resetting thermal fuse (Polyswitch/PTC): additional protection against short circuits and overload
- Fixation of the cells thanks to super-adhesive tape: for improved resistance to impacts and mechanical protection

|          |    |  |
|----------|----|--|
| 00077523 |    |  |
| 6        | HB |  |



**hama**

"DP 482" Lithium Ion Battery for Nikon EN-EL14a

|                 |         |
|-----------------|---------|
| Shade of colour | Black   |
| Capacity        | 800 mAh |
| Voltage         | 7.4 V   |
| Model           | Li-Ion  |

- Use with UL/IEC-certified branded cells: for increased safety
- Safety electronics: for monitoring of the charging and discharge process
- Gold-plated contacts: for fewer contact losses and prevention of corrosion
- Self-resetting thermal fuse (Polyswitch/PTC): additional protection against short circuits and overload

|          |    |  |
|----------|----|--|
| 00077514 |    |  |
| 6        | HB |  |



**hama**

"DP 344" Li-Ion Battery for Olympus Li-50B

|          |         |
|----------|---------|
| Capacity | 800 mAh |
| Voltage  | 3.7 V   |
| Model    | Li-Ion  |

- Use with UL/IEC-certified branded cells: for increased safety
- Safety electronics: for monitoring of the charging and discharge process
- Gold-plated contacts: for fewer contact losses and prevention of corrosion
- Self-resetting thermal fuse (Polyswitch/PTC): additional protection against short circuits and overload

|          |    |  |
|----------|----|--|
| 00077530 |    |  |
| 6        | HB |  |



# Rechargeable Batteries & Powerpacks



**hama**

"DP 378" Li-Ion Battery for Panasonic CGA-S005E

|          |          |
|----------|----------|
| Capacity | 1050 mAh |
| Voltage  | 3.7 V    |
| Model    | Li-Ion   |

- Use with UL/IEC-certified branded cells: for increased safety
- Safety electronics: for monitoring of the charging and discharge process
- Gold-plated contacts: for fewer contact losses and prevention of corrosion
- Self-resetting thermal fuse (Polyswitch/PTC): additional protection against short circuits and overload

|          |    |  |
|----------|----|--|
| 00077537 |    |  |
| 6        | HB |  |



**hama**

"DP 307" Lithium Ion Battery for Panasonic CGR-S006E

|          |         |
|----------|---------|
| Capacity | 700 mAh |
| Voltage  | 7.2 V   |
| Model    | Li-Ion  |

- Use with UL/IEC-certified branded cells: for increased safety
- Safety electronics: for monitoring of the charging and discharge process
- Gold-plated contacts: for fewer contact losses and prevention of corrosion
- Self-resetting thermal fuse (Polyswitch/PTC): additional protection against short circuits and overload

|          |    |  |
|----------|----|--|
| 00077524 |    |  |
| 6        | HB |  |



**hama**

"DP 541" Lithium Ion Battery for Panasonic DMW-BLG10

|                 |         |
|-----------------|---------|
| Shade of colour | Black   |
| Capacity        | 700 mAh |
| Voltage         | 7.2 V   |
| Model           | Li-Ion  |

- Use with UL/IEC-certified branded cells: for increased safety
- Safety electronics: for monitoring of the charging and discharge process
- Gold-plated contacts: for fewer contact losses and prevention of corrosion
- Self-resetting thermal fuse (Polyswitch/PTC): additional protection against short circuits and overload

|          |    |  |
|----------|----|--|
| 00077541 |    |  |
| 6        | HB |  |



**hama**

"DP 315" Lithium Ion Battery for Sony NP-BG1

|          |         |
|----------|---------|
| Capacity | 950 mAh |
| Voltage  | 3.6 V   |
| Model    | Li-Ion  |

- Use with UL/IEC-certified branded cells: for increased safety
- Safety electronics: for monitoring of the charging and discharge process
- Gold-plated contacts: for fewer contact losses and prevention of corrosion
- Self-resetting thermal fuse (Polyswitch/PTC): additional protection against short circuits and overload

|          |    |  |
|----------|----|--|
| 00077528 |    |  |
| 6        | HB |  |



**hama**

"DP 317" Lithium Ion Battery for Panasonic CGA-S007E

|          |         |
|----------|---------|
| Capacity | 800 mAh |
| Voltage  | 3.7 V   |
| Model    | Li-Ion  |

- Use with branded cells: for increased safety
- Safety electronics: for monitoring of the charging and discharge process
- Gold-plated contacts: for fewer contact losses and prevention of corrosion
- Self-resetting thermal fuse (Polyswitch/PTC): additional protection against short circuits and overload

|          |    |  |
|----------|----|--|
| 00077532 |    |  |
| 6        | HB |  |



**hama**

"DP 461" Lithium Ion Battery for Panasonic DMW-BLC12

|          |         |
|----------|---------|
| Capacity | 950 mAh |
| Voltage  | 7.2 V   |
| Model    | Li-Ion  |

- Use with UL/IEC-certified branded cells: for increased safety
- Safety electronics: for monitoring of the charging and discharge process
- Gold-plated contacts: for fewer contact losses and prevention of corrosion
- Self-resetting thermal fuse (Polyswitch/PTC): additional protection against short circuits and overload

|          |    |  |
|----------|----|--|
| 00077540 |    |  |
| 6        | HB |  |



**hama**

"DP 545" Lithium Ion Battery for Sony NP-BG1

|                 |          |
|-----------------|----------|
| Shade of colour | Black    |
| Capacity        | 1020 mAh |
| Voltage         | 3.6 V    |
| Model           | Li-Ion   |

- Use with UL/IEC-certified branded cells: for increased safety
- Safety electronics: for monitoring of the charging and discharge process
- Gold-plated contacts: for fewer contact losses and prevention of corrosion
- Self-resetting thermal fuse (Polyswitch/PTC): additional protection against short circuits and overload

|          |    |  |
|----------|----|--|
| 00077545 |    |  |
| 6        | HB |  |



**hama**

"DP 547" Lithium Ion Battery for Sony NP-BN1

|                 |         |
|-----------------|---------|
| Shade of colour | Black   |
| Capacity        | 580 mAh |
| Voltage         | 3.6 V   |
| Model           | Li-Ion  |

- Use with UL/IEC-certified branded cells: for increased safety
- Safety electronics: for monitoring of the charging and discharge process
- Gold-plated contacts: for fewer contact losses and prevention of corrosion
- Self-resetting thermal fuse (Polyswitch/PTC): additional protection against short circuits and overload

|          |    |  |
|----------|----|--|
| 00077547 |    |  |
| 6        | HB |  |

ENERGY



**hama**

**"DP 460" Lithium Ion Battery for Sony NP-BX1**

|                 |          |
|-----------------|----------|
| Shade of colour | Black    |
| Capacity        | 1090 mAh |
| Voltage         | 3.6 V    |
| Model           | Li-Ion   |

- Use with UL/IEC-certified branded cells: for increased safety
- Safety electronics: for monitoring of the charging and discharge process
- Gold-plated contacts: for fewer contact losses and prevention of corrosion
- Self-resetting thermal fuse (Polyswitch/PTC): additional protection against short circuits and overload

|  |   |    |                 |
|--|---|----|-----------------|
|  |   |    | <b>00077519</b> |
|  | 6 | HB |                 |



**hama**

**"DP 551" Lithium Ion Battery for Sony NP-FW50**

|                 |          |
|-----------------|----------|
| Shade of colour | Black    |
| Capacity        | 1000 mAh |
| Voltage         | 7.2 V    |
| Model           | Li-Ion   |

- Use with UL/IEC-certified branded cells: for increased safety
- Safety electronics: for monitoring of the charging and discharge process
- Gold-plated contacts: for fewer contact losses and prevention of corrosion
- Self-resetting thermal fuse (Polyswitch/PTC): additional protection against short circuits and overload

|  |   |    |                 |
|--|---|----|-----------------|
|  |   |    | <b>00077551</b> |
|  | 6 | HB |                 |



**hama**

**"DP 542" Lithium Ion Battery for Sony NP-FZ100**

|                 |          |
|-----------------|----------|
| Shade of colour | Black    |
| Capacity        | 1940 mAh |
| Voltage         | 7.2 V    |
| Model           | Li-Ion   |

- Use with UL/IEC-certified branded cells: for increased safety
- Safety electronics: for monitoring of the charging and discharge process
- Gold-plated contacts: for fewer contact losses and prevention of corrosion
- Fixation of the cells thanks to super-adhesive tape: for improved resistance to impacts and mechanical protection

|  |   |    |                 |
|--|---|----|-----------------|
|  |   |    | <b>00077542</b> |
|  | 6 | HB |                 |

Charger



**hama**

**Charger "Travel for Canon", Black**

- LED function indicator gives information about the charge state
- Fast, simple and safe charging of the battery
- Perfect fit of the battery in the charger
- USB charging connection for USB mains adapters, USB car chargers, power packs
- Incl. USB connection cable (USB-A plug to micro-USB)
- Short-circuit-proof and reverse polarity protected (mechanical)

|  |   |    |               |                 |
|--|---|----|---------------|-----------------|
|  |   |    | <b>LP-E10</b> | <b>00081414</b> |
|  | 6 | HB |               |                 |



**hama**

**Charger "Travel for Canon", Black**

- LED function indicator gives information about the charge state
- Fast, simple and safe charging of the battery
- Perfect fit of the battery in the charger
- USB charging connection for USB mains adapters, USB car chargers, power packs
- Incl. USB connection cable (USB-A plug to micro-USB)
- Short-circuit-proof and reverse polarity protected (mechanical)

|  |   |    |              |                 |
|--|---|----|--------------|-----------------|
|  |   |    | <b>LP-E6</b> | <b>00081415</b> |
|  | 6 | HB |              |                 |



**hama**

**Charger "Travel for Canon", Black**

- LED function indicator gives information about the charge state
- Fast, simple and safe charging of the battery
- Perfect fit of the battery in the charger
- USB charging connection for USB mains adapters, USB car chargers, power packs
- Incl. USB connection cable (USB-A plug to micro-USB)
- Short-circuit-proof and reverse polarity protected (mechanical)

|  |   |    |              |                 |
|--|---|----|--------------|-----------------|
|  |   |    | <b>LP-E8</b> | <b>00081417</b> |
|  | 6 | HB |              |                 |



**hama**

**Charger "Travel for Canon", Black**

- LED function indicator gives information about the charge state
- Fast, simple and safe charging of the battery
- Perfect fit of the battery in the charger
- USB charging connection for USB mains adapters, USB car chargers, power packs
- Incl. USB connection cable (USB-A plug to micro-USB)
- Short-circuit-proof and reverse polarity protected (mechanical)

|  |   |    |              |                 |
|--|---|----|--------------|-----------------|
|  |   |    | <b>LP-E7</b> | <b>00081420</b> |
|  | 6 | HB |              |                 |



# Charger & Power Supply Units



**hama**

**Charger**  
"Travel for Canon", Black

- LED function indicator gives information about the charge state
- Fast, simple and safe charging of the battery
- Perfect fit of the battery in the charger
- USB charging connection for USB mains adapters, USB car chargers, power packs
- Incl. USB connection cable (USB-A plug to micro-USB)
- Short-circuit-proof and reverse polarity protected (mechanical)

|        |          |
|--------|----------|
| NB-11L | 00081422 |
| 6 HB   |          |



**hama**

**Charger**  
"Travel for Canon", Black

- LED function indicator gives information about the charge state
- Fast, simple and safe charging of the battery
- Perfect fit of the battery in the charger
- USB charging connection for USB mains adapters, USB car chargers, power packs
- Incl. USB connection cable (USB-A plug to micro-USB)
- Short-circuit-proof and reverse polarity protected (mechanical)

|               |          |
|---------------|----------|
| NB-12L/NB-13L | 00081426 |
| 6 HB          |          |



**hama**

**Charger**  
"Travel for Nikon", Black

- LED function indicator gives information about the charge state
- Fast, simple and safe charging of the battery
- Perfect fit of the battery in the charger
- USB charging connection for USB mains adapters, USB car chargers, power packs
- Incl. USB connection cable (USB-A plug to micro-USB)
- Short-circuit-proof and reverse polarity protected (mechanical)

|                  |          |
|------------------|----------|
| EN-EL14/EN-EL14a | 00081412 |
| 6 HB             |          |



**hama**

**Charger**  
"Travel for Nikon", Black

- LED function indicator gives information about the charge state
- Fast, simple and safe charging of the battery
- Perfect fit of the battery in the charger
- USB charging connection for USB mains adapters, USB car chargers, power packs
- Incl. USB connection cable (USB-A plug to micro-USB)
- Short-circuit-proof and reverse polarity protected (mechanical)

|         |          |
|---------|----------|
| EN-EL12 | 00081428 |
| 6 HB    |          |



**hama**

**Charger**  
"Travel for Canon", Black

- LED function indicator gives information about the charge state
- Fast, simple and safe charging of the battery
- Perfect fit of the battery in the charger
- USB charging connection for USB mains adapters, USB car chargers, power packs
- Incl. USB connection cable (USB-A plug to micro-USB)
- Short-circuit-proof and reverse polarity protected (mechanical)

|        |          |
|--------|----------|
| LP-E12 | 00081424 |
| 6 HB   |          |



**hama**

**Charger**  
"Travel for Canon", Black

- LED function indicator gives information about the charge state
- Fast, simple and safe charging of the battery
- Perfect fit of the battery in the charger
- USB charging connection for USB mains adapters, USB car chargers, power packs
- Incl. USB connection cable (USB-A plug to micro-USB)
- Short-circuit-proof and reverse polarity protected (mechanical)

|       |          |
|-------|----------|
| NB-6L | 00081429 |
| 6 HB  |          |



**hama**

**Charger**  
"Travel for Nikon", Black

- LED function indicator gives information about the charge state
- Fast, simple and safe charging of the battery
- Perfect fit of the battery in the charger
- USB charging connection for USB mains adapters, USB car chargers, power packs
- Incl. USB connection cable (USB-A plug to micro-USB)
- Short-circuit-proof and reverse polarity protected (mechanical)

|         |          |
|---------|----------|
| EN-EL15 | 00081419 |
| 6 HB    |          |



**hama**

**Charger**  
"Travel for Nikon", Black

- LED function indicator gives information about the charge state
- Fast, simple and safe charging of the battery
- Perfect fit of the battery in the charger
- USB charging connection for USB mains adapters, USB car chargers, power packs
- Incl. USB connection cable (USB-A plug to micro-USB)
- Short-circuit-proof and reverse polarity protected (mechanical)

|        |          |
|--------|----------|
| EN-EL9 | 00081431 |
| 6 HB   |          |



# Charger & Power Supply Units



**hama**

**Charger**  
"Travel for Nikon", Black

- LED function indicator gives information about the charge state
- Fast, simple and safe charging of the battery
- Perfect fit of the battery in the charger
- USB charging connection for USB mains adapters, USB car chargers, power packs
- Incl. USB connection cable (USB-A plug to micro-USB)
- Short-circuit-proof and reverse polarity protected (mechanical)

|        |  |   |    |  |  |  |  |  |                 |
|--------|--|---|----|--|--|--|--|--|-----------------|
| EN-EL5 |  |   |    |  |  |  |  |  | <b>00081432</b> |
|        |  | 6 | HB |  |  |  |  |  |                 |



**hama**

**Charger**  
"Travel for Panasonic", Black

- LED function indicator gives information about the charge state
- Fast, simple and safe charging of the battery
- Perfect fit of the battery in the charger
- USB charging connection for USB mains adapters, USB car chargers, power packs
- Incl. USB connection cable (USB-A plug to micro-USB)

|           |  |   |    |  |  |  |  |  |                 |
|-----------|--|---|----|--|--|--|--|--|-----------------|
| DMW-BLG10 |  |   |    |  |  |  |  |  | <b>00081416</b> |
|           |  | 6 | HB |  |  |  |  |  |                 |
| DMW-BLC12 |  |   |    |  |  |  |  |  | <b>00081418</b> |
|           |  | 6 | HB |  |  |  |  |  |                 |



**hama**

**Charger**  
"Travel for Sony", Black

- LED function indicator gives information about the charge state
- Fast, simple and safe charging of the battery
- Perfect fit of the battery in the charger
- USB charging connection for USB mains adapters, USB car chargers, power packs
- Incl. USB connection cable (USB-A plug to micro-USB)
- Short-circuit-proof and reverse polarity protected (mechanical)

|          |  |   |    |  |  |  |  |  |                 |
|----------|--|---|----|--|--|--|--|--|-----------------|
| NP-FZ100 |  |   |    |  |  |  |  |  | <b>00081421</b> |
|          |  | 6 | HB |  |  |  |  |  |                 |



**hama**

**Charger**  
"Travel for Sony", Black

- LED function indicator gives information about the charge state
- Fast, simple and safe charging of the battery
- Perfect fit of the battery in the charger
- USB charging connection for USB mains adapters, USB car chargers, power packs
- Incl. USB connection cable (USB-A plug to micro-USB)
- Short-circuit-proof and reverse polarity protected (mechanical)

|        |  |   |    |  |  |  |  |  |                 |
|--------|--|---|----|--|--|--|--|--|-----------------|
| NP-BG1 |  |   |    |  |  |  |  |  | <b>00081425</b> |
|        |  | 6 | HB |  |  |  |  |  |                 |



**hama**

**Charger**  
"Travel for Olympus", Black

- LED function indicator gives information about the charge state
- Fast, simple and safe charging of the battery
- Perfect fit of the battery in the charger
- USB charging connection for USB mains adapters, USB car chargers, power packs
- Incl. USB connection cable (USB-A plug to micro-USB)
- Short-circuit-proof and reverse polarity protected (mechanical)

|               |  |   |    |  |  |  |  |  |                 |
|---------------|--|---|----|--|--|--|--|--|-----------------|
| LI-40B/LI-42B |  |   |    |  |  |  |  |  | <b>00081430</b> |
|               |  | 6 | HB |  |  |  |  |  |                 |



**hama**

**Charger**  
"Travel for Sony", Black

- LED function indicator gives information about the charge state
- Fast, simple and safe charging of the battery
- Perfect fit of the battery in the charger
- USB charging connection for USB mains adapters, USB car chargers, power packs
- Incl. USB connection cable (USB-A plug to micro-USB)
- Short-circuit-proof and reverse polarity protected (mechanical)

|        |  |   |    |  |  |  |  |  |                 |
|--------|--|---|----|--|--|--|--|--|-----------------|
| NP-BX1 |  |   |    |  |  |  |  |  | <b>00081413</b> |
|        |  | 6 | HB |  |  |  |  |  |                 |



**hama**

**Charger**  
"Travel for Sony", Black

- LED function indicator gives information about the charge state
- Fast, simple and safe charging of the battery
- Perfect fit of the battery in the charger
- USB charging connection for USB mains adapters, USB car chargers, power packs
- Incl. USB connection cable (USB-A plug to micro-USB)
- Short-circuit-proof and reverse polarity protected (mechanical)

|        |  |   |    |  |  |  |  |  |                 |
|--------|--|---|----|--|--|--|--|--|-----------------|
| NP-BN1 |  |   |    |  |  |  |  |  | <b>00081423</b> |
|        |  | 6 | HB |  |  |  |  |  |                 |



**hama**

**Charger**  
"Travel for Sony", Black

- LED function indicator gives information about the charge state
- Fast, simple and safe charging of the battery
- Perfect fit of the battery in the charger
- USB charging connection for USB mains adapters, USB car chargers, power packs
- Incl. USB connection cable (USB-A plug to micro-USB)
- Short-circuit-proof and reverse polarity protected (mechanical)

|         |  |   |    |  |  |  |  |  |                 |
|---------|--|---|----|--|--|--|--|--|-----------------|
| NP-FW50 |  |   |    |  |  |  |  |  | <b>00081411</b> |
|         |  | 6 | HB |  |  |  |  |  |                 |







# Accessories for Flashes



# Flash accessories

## Flash/Lighting Rail



**hama**

**Flash Bracket, 90°, foldable, black**

| Material  | Metal, Plastic Material |
|-----------|-------------------------|
| W x H x L | 3.4 x 14 x 19 cm        |

- For all flash units, lights, synchro-mats and tilt heads with a standard accessory shoe
- For all photo/video cameras with a tripod socket
- Sliding A 1/4" (6.4 mm) camera screw and B 1/4" (6.4 mm) tripod socket
- Hand grip for ease of use
- With a hand strap for a secure hold
- Plastic surface
- Being foldable and compact, the bracket is ultra portable
- Larger illumination angle as the flash unit is attached next to the camera
- Prevents the effect of "red eye" as the flash comes from another angle and not directly from near the lens as this would be the case without a flash bracket
- Easy to use: the camera and flash unit are compactly attached to the flash bracket that ensures optimal weight shift for portrait shots

|               |                 |
|---------------|-----------------|
| 1/4" (6.4 mm) | <b>00006831</b> |
| 6 BK          |                 |



**hama**

**"V" Flash Rail**

| Material  | Metal, Plastic Material |
|-----------|-------------------------|
| W x H x L | 16.4 x 3.5 x 20 cm      |

- For devices such as flash units, lights, microphones, spirit levels, etc. with standard flash foot
- Suitable for photo / video cameras with flash shoe
- Also suitable for smartphones and all devices with a 1/4" thread
- Multiple options to attach accessories and arrange the shot
- Easy handling: accessories are attached compactly to the camera's flash shoe

|               |                 |
|---------------|-----------------|
| 1/4" (6.4 mm) | <b>00006810</b> |
| 60 BK         |                 |



**hama**

**Flash Rail, 30 x 177 mm, black/grey**

| Material  | Plastic Material  |
|-----------|-------------------|
| W x H x L | 3 x 2.3 x 17.7 cm |

- For all flash devices, lights, Synchro-mats and tilt heads with standard attachment base
- Suitable for photo / video cameras with tripod thread
- With a standard flash shoe and mobile camera screw A 1/4" (6.4 mm), tripod thread B 1/4" (6.4 mm)
- Plastic runner
- Wider lighting angle, because the flash device is attached next to the camera
- Prevents the "red-eye effect" because the flash is coming from a different angle, and not, as is the case without the flash rail, directly from the proximity of the lens
- Easy handling: the camera and flash device are compactly attached to the flash rail, and the flash rail ensures the ideal distribution of weight for portrait shots

|               |                 |
|---------------|-----------------|
| 1/4" (6.4 mm) | <b>00006815</b> |
| 6 BK          |                 |

## Flash Adapter/Tilt Head



**hama**

**Plug-in Foot with Tripod Thread**

| Contact | Isolated Center Contact |
|---------|-------------------------|
|         |                         |

- Tripod threads (A 1/4"/6.4 mm) and 2 locking nuts
- Foot without threaded hole for attachment and secure fastening to the camera or rail's flash shoe

|        |                 |
|--------|-----------------|
| Silver | <b>00006958</b> |
| 6 BK   |                 |



**hama**

**Accessory Shoe with Insulating Plate**

| Contact | Isolated Center Contact |
|---------|-------------------------|
|         |                         |

- Isolating plate prevents the current flow from the camera to the photography accessories and vice versa
- With tripod socket B 1/4"

|       |                 |
|-------|-----------------|
| Black | <b>00006959</b> |
| 6 BK  |                 |

# Clean & Care



# Cleaners & Care Products

## Compressed Air Cleaner



**hama**

### Compressed Air Cleaner "AntiDust"

- Ideal for cleaning hard-to-access parts of cameras and equipment
- Monoblock tin with screw head for increased blow intensity
- Gas pressure stable until the end of the filling process
- With spray valve and capillary tube

|        |                 |      |  |
|--------|-----------------|------|--|
| 400 ml | <b>00005801</b> |      |  |
|        | 30              | K.A. |  |
| 250 ml | <b>00005800</b> |      |  |
|        | 30              | K.A. |  |

## Dust-Ex Brush



**hama**

### "Dust Ex 55" Air Blower

|                        |         |
|------------------------|---------|
| Diameter Rubber Bellow | 5.5 cm  |
| Length                 | 16.6 cm |

- Removes dust, crumbs and other small particles without touching the surface
- Valve system creates an optimal gust of air
- Environmentally friendly as neither liquid nor chemicals are required for cleaning
- Talc free

|            |                 |    |  |
|------------|-----------------|----|--|
| Black, Red | <b>00005610</b> |    |  |
|            | 6               | BK |  |



**hama**

### Air Blower "Dust Ex Brush 55"

|                        |        |
|------------------------|--------|
| Diameter Rubber Bellow | 5.5 cm |
| Length                 | 16 cm  |

- With a brush for removing heavy soiling and coarse particles
- Air blower removes dust, crumbs and other small particles without touching the surface
- Valve system for optimised blowing action
- Brush can be attached to the side when not in use
- Environment-friendly as cleaning requires no fluids or chemicals

|       |                 |    |  |
|-------|-----------------|----|--|
| Black | <b>00005649</b> |    |  |
|       | 6               | HB |  |

## Contact Cleaner



**hama**

### "Glass Fibre" Contact Cleaner

|              |                       |
|--------------|-----------------------|
| Suitable for | Batteries and Devices |
|--------------|-----------------------|

- Length of glass fibre refill: 25 mm
- Length of pen: 120 mm

|  |                 |    |  |
|--|-----------------|----|--|
|  | <b>00005629</b> |    |  |
|  | 6               | BK |  |



CLEAN & CARE

## Cleaning Kit



**hama**

### "Optic Dry" Photo Cleaning Set, 4-part

• Set consisting of:

Dust Ex Brush:

- With brush, for removing heavy soiling and coarser particles
- Air blower removes dust, crumbs and other small particles without touching the surface
- Valve system for optimised blowing action
- Brush can be attached to the side when not in use
- Environment-friendly
- Talc-free

Cleaning Cloth:

- Removes dirt and dust from all optical surfaces
- Especially high-quality microfibre cloth for lint-free cleaning

Lenspen:

- Highly efficient and gentle cleaning of all optical surfaces, especially for lenses and filters
- Ready for use immediately, since the screw lock ensures automatic activation of the velvety surface and means that no special activation of the fibres is required
- Especially long-lasting, since no liquid can dry out or leak with dry cleaning
- Original Lenspen
- Removes dust, specks of grease and other dirt
- Does not dry out
- With lens brush for dry pre-cleaning
- Special coating for high-quality lenses
- Handy pen shape with retaining clip in an ergonomic design

00005954

6 HB



**hama**

### "Optic HTMC Dust Ex" Photo Cleaning Set, 4-part

- With a brush for removing heavy soiling and coarse particles
- Made without silicone which avoids the formation of smears
- Set consisting of:

Dust Ex Brush:

- Air blower removes dust, crumbs and other small particles without touching the surface
- Valve system for optimised blowing action
- Brush can be attached to the side when not in use
- Environment-friendly
- Talc-free

"HTMC-Special" Lens Cleaner, 12 ml:

- For gentle, wet cleaning
- Superior quality fluid for smear-free cleaning
- Incl. application brush

30 Sheets of Fine Lens Paper:

- Optimised for wet cleaning with special cleaning fluid

Practical Mesh Storage Pouch, 12.5 x 17 cm

00005946

6 HB



**hama**

### "Optic HTMC" Photo Cleaning Set, 4-part

- With a brush for removing heavy soiling and coarse particles
- Made without silicone which avoids the formation of smears
- Set consisting of:

"Pneu 40" Lens Brush:

- Air blower removes dust, crumbs and other small particles without touching the surface
- Valve system for optimised blowing action
- With protective cap
- Environment-friendly
- Talc-free

"HTMC-Special" Lens Cleaner, 12 ml:

- For gentle, wet cleaning
- Superior quality fluid for smear-free cleaning
- Incl. application brush

30 Sheets of Fine Lens Paper:

- Optimised for wet cleaning with special cleaning fluid

Practical Mesh Storage Pouch, 13 x 18 cm

00005947

6 HB

## Cleaning Pen

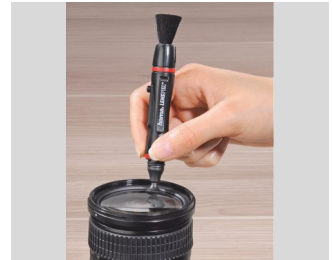

**hama**

### "Classic" Lens Pen

| Material Cleaning Spike | Special Velvet |
|-------------------------|----------------|
| Diameter Cleaning Spike | 13 mm          |
| Nib Length              | 11.5 cm        |

- Immediately ready for use as the screw closure ensures automatic activation of the velvety surface, no need to activate the fibers separately
- Particularly long service life as dry cleaning means that no liquid can dry out or run out
- Original lens pen
- Removes dust, grease spots and other smudges
- Does not dry out
- With a lens brush for dry pre-cleaning
- Special coating for high-quality lenses
- Conveniently shaped pen with a clip for attachment and an ergonomic design
- Curved velvety surface
- Diameter: 13 mm, especially for lenses and filters

Black

00005961

20 BK



CLEAN & CARE

# Cleaners & Care Products

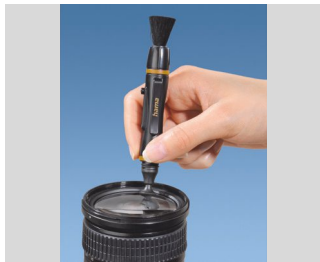

**hama**

Lenspen, black/gold

| Material Cleaning Spike | Special Velvet |
|-------------------------|----------------|
| Diameter Cleaning Spike | 13 mm          |
| Nib Length              | 11 cm          |

- Immediately ready for use as the screw closure ensures automatic activation of the velvety surface, no need to activate the fibers separately
- Particularly long service life as dry cleaning means that no liquid can dry out or run out
- Original Lenspen
- Removes dust, specks of grease and other dirt
- Does not dry out
- With lens brush for dry pre-cleaning
- Special coating for high-quality lenses
- Handy pen shape with retaining clip in an ergonomic design
- Curved velvet surface
- Diameter 13 mm: especially for lenses and filters

|       |    |    |  |                 |
|-------|----|----|--|-----------------|
| Black |    |    |  | <b>00078692</b> |
|       | 20 | BK |  |                 |



**hama**

Lens Pen

| Material Cleaning Spike | Special Velvet |
|-------------------------|----------------|
| Diameter Cleaning Spike | 13 mm          |
| Nib Length              | 12.5 cm        |

- Particularly long service life as dry cleaning means that no liquid can dry out or run out
- Removes dust, grease spots and other smudges
- Does not dry out
- With a lens brush for dry pre-cleaning
- Conveniently shaped pen with a clip for attachment
- Curved velvety surface
- Diameter: 13 mm, especially for lenses and filters

|       |    |    |  |                 |
|-------|----|----|--|-----------------|
| Black |    |    |  | <b>00005604</b> |
|       | 20 | BK |  |                 |

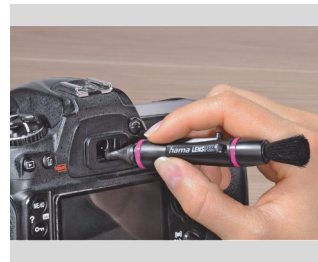

**hama**

"MicroPro II" Lens Pen

| Material Cleaning Spike | Special Velvet |
|-------------------------|----------------|
| Diameter Cleaning Spike | 5 mm           |
| Nib Length              | 9 cm           |

- Particularly long service life as dry cleaning means that no liquid can dry out or run out
- Immediately ready for use as the screw closure ensures automatic activation of the velvety surface, no need to activate the fibers separately
- Original lens pen
- Removes dust, grease spots and other smudges
- Does not dry out
- With a lens brush for dry pre-cleaning
- Special coating for high-quality lenses
- Small and handy pen with a clip for attachment and an ergonomic design
- Flat velvety surface
- Diameter: 5 mm, especially for eyepieces and smartphone cameras

|       |    |    |  |                 |
|-------|----|----|--|-----------------|
| Black |    |    |  | <b>00005964</b> |
|       | 20 | BK |  |                 |

Cleaning Cloth



**hama**

Anti-static Cloth, 25 x 23 cm

|                |             |
|----------------|-------------|
| Material       | 100% Cotton |
| Width x Length | 23 x 25 cm  |

- The antistatic effect prevents dust from accumulating again after the cleaning process
- Especially high-quality cleaning cloth made from 100% cotton for lint-free cleaning
- Excellent cleaning effect thanks to high-quality fibre structure

|        |   |    |  |                 |
|--------|---|----|--|-----------------|
| Orange |   |    |  | <b>00005999</b> |
|        | 8 | HB |  |                 |



**hama**

Cleaning Cloth  
"Pro-Optic, 24 Packs/Display Box"

|                |            |
|----------------|------------|
| Material       | Paper      |
| Width x Length | 12 x 14 cm |

- The antistatic effect prevents dust from accumulating again after the cleaning process
- Wet cleaning perfect for stubborn dirt
- Ideal for travel

|              |    |    |  |                 |
|--------------|----|----|--|-----------------|
| Cream Nature |    |    |  | <b>00005970</b> |
|              | 24 | SC |  |                 |

CLEAN & CARE



**hama**

**Cleaning Cloth  
"Micro, 24 Pieces in a Display Box"**

|                |                |
|----------------|----------------|
| Material       | 80% Polyester  |
| Width x Length | 15.5 x 15.5 cm |

- Microfibre cloth of superior quality for lint-free cleaning
- Cleans effectively thanks to its high-quality fibre structure
- Microfibre cleaning cloth (20% nylon, 80% polyester)

|            |                 |
|------------|-----------------|
| Light Grey | <b>00005904</b> |
|            | 24 SC           |



**hama**

**"Pocket" Microfibre Cleaning Cloth, black**

|                |            |
|----------------|------------|
| Material       | Microfibre |
| Width x Length | 15 x 15 cm |

- With clip for handy transport on the camera bag, carrying strap or keyring
- With neoprene protective pouch
- Excellent cleaning effect thanks to high-quality fibre structure
- Washable by hand, allowing it to be reused

|       |                 |
|-------|-----------------|
| Black | <b>00005840</b> |
|       | 8 HB            |



**hama**

**Optical Paper, 5 x 30 Pages**

|                |           |
|----------------|-----------|
| Width x Length | 12 x 6 cm |
|----------------|-----------|

- Made without silicone which avoids the formation of smears
- Optimised for wet cleaning with special cleaning fluid

|                     |                 |
|---------------------|-----------------|
| Beige, Cream Nature | <b>00005956</b> |
|                     | 6 HB            |



**hama**

**"Micro" Optical Cleaning Cloth, 14 Pcs in Display**

|                |               |
|----------------|---------------|
| Material       | 80% Polyester |
| Width x Length | 20 x 20 cm    |

- Microfibre cloth of superior quality for lint-free cleaning
- Ensures thorough and gentle cleaning

|            |                 |
|------------|-----------------|
| Light Grey | <b>00005989</b> |
|            | 14 SC           |



**hama**

**Cleaning Set with 30 "Pro-Optik" Moist Wipes and 1 Microfibre Cloth**

|                |            |
|----------------|------------|
| Material       | Microfibre |
| Width x Length | 12 x 14 cm |

- The antistatic effect prevents dust from accumulating again after the cleaning process
- Microfibre cloth of superior quality for lint-free cleaning
- Moist disposable wipes for wet cleaning - ideal for stubborn dirt and perfect for when out and about
- High-quality microfibre cloth for subsequent polishing to deliver excellent cleaning without smears or streaks

|       |                 |
|-------|-----------------|
| Black | <b>00005988</b> |
|       | 6 HB            |



CLEAN & CARE





# Storage Media & Accessories



# Players | Bags & Cases

## MP3 Player (DS)



**SanDisk**

**MP3 Player (DS)  
"Clip Jam 8GB"**

|                      |      |
|----------------------|------|
| Max. Battery Runtime | 18 h |
|----------------------|------|

- large, bright and easy to read 0.96 inch white OLED (128x64) display and large navigation buttons
- 8GB internal storage capacity, with integrated microSD memory card slot for storage expansion
- integrated FM radio

|       |          |
|-------|----------|
| Blue  | 00121512 |
| Black | 00121513 |
| Green | 00121514 |
| Pink  | 00121516 |
| Red   | 00121515 |
|       | 10 HB    |



**SanDisk**

**MP3 Player (DS)  
"Clip Sport Plus 32GB"**

- Super light; can be clipped onto clothing or equipment
- Durable and water-resistant with IPX5 certification
- Integrated FM radio
- Plays for up to 20 hours on a single charge (wired connection)
- USB 2.0 Micro-B port for high-speed transfer and charging
- Operating System: Windows 10/8/7/ Vista, MacOS X Ver. 10.3 or higher

|       |          |
|-------|----------|
| Blue  | 00121521 |
| Black | 00121522 |
|       | 10 HB    |

## Bag



**hama**

**Memory Card Case, black**

|               |              |
|---------------|--------------|
| Material      | Faux Leather |
| Max. Capacity | 18           |

- High-quality, antistatic sleeves
- Index can be labelled, allowing for organised archiving
- With carrying strap

|  |          |
|--|----------|
|  | 00095983 |
|  | 90 SU    |



**hama**

**Memory Card Case, black**

|               |              |
|---------------|--------------|
| Material      | Faux Leather |
| Max. Capacity | 12           |

- High-quality, antistatic sleeves
- Index can be labelled, allowing for organised archiving
- With carrying strap

|  |          |
|--|----------|
|  | 00095980 |
|  | 120 SU   |

STORAGE MEDIA & ACCESSORIES



**SanDisk**

**MP3 Player (DS)  
"Clip Sport Go 32GB, New"**

|                      |                         |
|----------------------|-------------------------|
| Display Size         | 1,22 cm (0,48")         |
| Battery Type         | Lithium Polymer Battery |
| Max. Battery Runtime | 18 h                    |

- Supports iTunes content (AAC codec), Audible (DRM), Windows Media Audio (no DRM), and MP3 formats
- Built-in FM radio perfect for the gym or your outdoor run
- Crisp LED screen and physical buttons for easy navigation

|       |          |
|-------|----------|
| Black | 00186588 |
| Blue  | 00186587 |
|       | 10 HB    |



**hama**

**"Vegas" Memory Card Case,  
size M, black**

|               |              |
|---------------|--------------|
| Material      | Faux Leather |
| Max. Capacity | 12           |

- Holds up to 8 SD and 4 microSD cards
- With specially developed safety insert
- Practical magnetic fastener

|  |          |
|--|----------|
|  | 00095964 |
|  | 120 HC   |



**hama**

**"Universal" Memory Card Case,  
large, black**

|               |              |
|---------------|--------------|
| Material      | Faux Leather |
| Max. Capacity | 5            |

- With a compartment for a Compact-Flash adapter
- Loops for up to 4 AA batteries and one stylus pen

|  |          |
|--|----------|
|  | 00047153 |
|  | 60 SU    |



**hama**

"Universal" Memory Card Case, small, black

|               |              |
|---------------|--------------|
| Material      | Faux Leather |
| Max. Capacity | 4            |

- With hook and loop fastener

|          |    |  |
|----------|----|--|
| 00047152 |    |  |
| 200      | HC |  |



**hama**

Bag "for Memory Cards", Graphite

|               |                    |
|---------------|--------------------|
| Material      | Polypropylene (PP) |
| Max. Capacity | 8                  |

- High-quality, antistatic sleeves
- Index can be labelled, allowing for organised archiving
- Holds up to 8 SD cards
- Coloured label on the back for easy sorting

|          |    |  |
|----------|----|--|
| 00095920 |    |  |
| 20       | HC |  |



**hama**

"Mini" Memory Card Case, black/grey

|               |         |
|---------------|---------|
| Material      | Polytex |
| Max. Capacity | 10      |

- Holds up to 10 memory cards
- 2 insert pockets for small parts

|          |    |  |
|----------|----|--|
| 00049916 |    |  |
| 30       | SU |  |



**hama**

"Fashion" USB Stick Case, black

|          |              |
|----------|--------------|
| Material | Faux Leather |
|----------|--------------|

- With a keyring e.g. for attachment to a bunch of keys
- With red stitching
- Press stud

|          |    |  |
|----------|----|--|
| 00090775 |    |  |
| 30       | HC |  |



**hama**

"Maxi" Memory Card Case, black/grey

|               |           |
|---------------|-----------|
| Material      | Polyester |
| Max. Capacity | 20        |

- Holds up to 20 memory cards
- Compartment for a PCMCIA adapter
- Loops for up to 5 AA batteries and one stylus pen
- Loops for a PDA or notepad plus replacement stylus
- With mesh pocket, e.g. for a USB stick

|          |    |  |
|----------|----|--|
| 00049917 |    |  |
| 60       | SU |  |



**hama**

Bag "for Memory Cards", Blue

|               |                    |
|---------------|--------------------|
| Material      | Polypropylene (PP) |
| Max. Capacity | 8                  |

- High-quality, antistatic sleeves
- Index can be labelled, allowing for organised archiving
- Holds up to 8 SD cards
- Coloured label on the back for easy sorting

|          |    |  |
|----------|----|--|
| 00095921 |    |  |
| 20       | HC |  |



**hama**

"Vegas" USB Stick Case for 5 USB Sticks, black

|          |              |
|----------|--------------|
| Material | Faux Leather |
|----------|--------------|

- Convenient, magnetic fastener

|          |    |  |
|----------|----|--|
| 00084409 |    |  |
| 120      | HC |  |



**hama**

"Brasil" USB Stick Case, 12 pieces in a display box

|          |       |
|----------|-------|
| Material | Nylon |
|----------|-------|

- With a snap hook and a hook and loop fastener
- 12 pieces in a display box: khaki, grey, blue, green, red, pink

|          |    |  |
|----------|----|--|
| 00084400 |    |  |
| 12       | SC |  |



STORAGE MEDIA & ACCESSORIES

# Bags & Cases | Memory Cards

## Sleeve



**hama**

Sleeve  
"SD, Pack of 5", Transparent, White

|                        |          |
|------------------------|----------|
| Max. Capacity (Pieces) | 2        |
| Suitable for           | SD & MMC |

- High-quality, antistatic sleeves
- For attaching two SD cards each to a file, folder, photo album, etc.

|          |    |  |
|----------|----|--|
| 00095950 |    |  |
| 100      | HC |  |

## SD Memory Card



**hama**

SD Memory Card  
"Memory Fast", 90 MB/s

|                      |                             |
|----------------------|-----------------------------|
| UHS Standard         | UHS-I                       |
| Standard Speed Class | Class 10, UHS Speed Class 1 |
| Video Speed Class    | V10                         |

- For real-time/broadcast recording; allows fast and direct data transfer between a memory card and a UHS-I capable terminal device
- SecureDigital Extended Capacity Card (SDXC), complies with SD 3.01 specifications
- Especially suited for real time full HD video and 3D video recording
- Mechanical write protection (against unintentional deleting)
- With a label area for short notes

|        |    |    |  |          |
|--------|----|----|--|----------|
| 256 GB |    |    |  | 00123997 |
|        | 24 | BK |  |          |
| 128 GB |    |    |  | 00124137 |
|        | 24 | BK |  |          |
| 64 GB  |    |    |  | 00124136 |
|        | 24 | BK |  |          |



**hama**

SD Memory Card  
"Memory Fast, narrow packaging", 90 MB/s

|                      |          |
|----------------------|----------|
| UHS Standard         | UHS-I    |
| Standard Speed Class | Class 10 |
| Video Speed Class    | V10      |

- For real-time/broadcast recording; allows fast and direct data transfer between a memory card and a UHS-I capable terminal device
- SecureDigital-Extended-Capacity-Card (SDXC), compliant to the SD-3.01 standard
- Especially suitable for real time full HD video and 3D video recording
- Mechanical write protection (against accidental deletion)
- With labelling field for short notes

|        |    |    |  |          |
|--------|----|----|--|----------|
| 128 GB |    |    |  | 00213111 |
|        | 32 | BK |  |          |
| 64 GB  |    |    |  | 00213110 |
|        | 32 | BK |  |          |



**hama**

SD Memory Card  
"Memory Fast", 80 MB/s

|                      |                             |
|----------------------|-----------------------------|
| UHS Standard         | UHS-I                       |
| Standard Speed Class | Class 10, UHS Speed Class 1 |
| Video Speed Class    | V10                         |

- For real-time/broadcast recording; allows fast and direct data transfer between a memory card and a UHS-I capable terminal device
- SecureDigital High Capacity Card (SDHC), complies with SD 3.01 specifications
- Especially suited for real time full HD video and 3D video recording
- Mechanical write protection (against unintentional deleting)
- With a label area for short notes

|       |    |    |  |          |
|-------|----|----|--|----------|
| 32 GB |    |    |  | 00124135 |
|       | 24 | BK |  |          |
| 16 GB |    |    |  | 00124134 |
|       | 24 | BK |  |          |



## hama

**SD Memory Card**  
"Memory Fast, narrow packaging", 80 MB/s

|                      |                             |
|----------------------|-----------------------------|
| UHS Standard         | UHS-I                       |
| Standard Speed Class | Class 10, UHS Speed Class 1 |
| Video Speed Class    | V10                         |

- For real-time/broadcast recording; allows fast and direct data transfer between a memory card and a UHS-I capable terminal device
- SecureDigital High Capacity Card (SDHC), meets new SD 3.01 standard
- Especially suitable for real time full HD video and 3D video recording
- Mechanical write protection against accidental deletion
- With labelling field for short notes

|       |          |
|-------|----------|
| 32 GB | 00181095 |
| 32 BK |          |
| 16 GB | 00181094 |
| 32 BK |          |

## hama

**SD Memory Card**  
"Memory Base", 45 MB/s

|                      |                             |
|----------------------|-----------------------------|
| UHS Standard         | UHS-I                       |
| Standard Speed Class | Class 10, UHS Speed Class 1 |

- For real-time/broadcast recording; allows fast and direct data transfer between a memory card and a UHS-I capable terminal device
- SecureDigital Extended Capacity Card (SDXC), complies with SD 3.0 specifications
- Ideal for high-resolution full HD video recording
- Mechanical write protection (against unintentional deleting)
- With a label area for short notes

|       |          |
|-------|----------|
| 64 GB | 00104379 |
| 24 BK |          |

## hama

**SD Memory Card**  
"Memory Base", 22 MB/s

|                      |          |
|----------------------|----------|
| Standard Speed Class | Class 10 |
|----------------------|----------|

- SecureDigital High Capacity Card (SDHC), complies with SD 2.0 specifications
- Ideal for high-resolution full HD video recording
- Mechanical write protection against unintentional deleting
- With a label area for short notes

|       |          |
|-------|----------|
| 32 GB | 00104368 |
| 24 BK |          |
| 16 GB | 00104367 |
| 24 BK |          |

## hama

**SD Memory Card**  
"Memory Base", 10 MB/s

|                      |         |
|----------------------|---------|
| Standard Speed Class | Class 4 |
|----------------------|---------|

- SecureDigital Card
- Suitable for terminal devices with SecureDigital slot
- Mechanical write protection against unintentional deleting
- With a label area for short notes

|       |          |
|-------|----------|
| 2 GB  | 00055377 |
| 24 BK |          |



# Memory Cards



## SanDisk

### SD Memory Card "Blue Label"

|                      |         |
|----------------------|---------|
| Standard Speed Class | Class 4 |
|----------------------|---------|

- Mechanical write protection against accidental deletion
- Cost-effective and reliable data storage for compact cameras and other devices
- Writeable label for easy identification and organisation
- Waterproof, temperature-proof, X-ray proof, and shockproof

|       |  |     |    |                 |
|-------|--|-----|----|-----------------|
| 64 GB |  |     |    | <b>00114820</b> |
|       |  | 100 | BK |                 |
| 32 GB |  |     |    | <b>00094195</b> |
|       |  | 100 | BK |                 |



## SanDisk

### SD Memory Card "Extreme Pro (V90)", 300 MB/s

|                      |                             |
|----------------------|-----------------------------|
| UHS Standard         | UHS-II                      |
| Standard Speed Class | Class 10, UHS Speed Class 3 |
| Video Speed Class    | V90                         |

- Ideal for pros who demand high performance, professional cameras and high-resolution camcorders
- Super-fast write speeds of up to 260MB/s help rapidly clear buffer time to support continuous burst mode shooting and cinema-quality video recording
- Sustained V90 video speeds and UHS Speed Class 3 (U3) deliver cinema-quality 8K, 4K and Full HD video recording
- Extreme transfer speeds up to 300MB/s help achieve maximum post-production workflow efficiency
- Engineered for taking RAW format pictures and sequential burst mode photography
- Waterproof, temperature-proof, X-ray proof, and shockproof
- RescuePRO Deluxe data recovery software download offer

|        |  |    |    |                 |
|--------|--|----|----|-----------------|
| 256 GB |  |    |    | <b>00215414</b> |
|        |  | 5  | BK |                 |
| 128 GB |  |    |    | <b>00121506</b> |
|        |  | 25 | BK |                 |
| 64 GB  |  |    |    | <b>00121505</b> |
|        |  | 50 | BK |                 |
| 32 GB  |  |    |    | <b>00121504</b> |
|        |  | 50 | BK |                 |



## SanDisk

### SD Memory Card "Extreme Pro"

|                      |          |
|----------------------|----------|
| UHS Standard         | UHS-II   |
| Standard Speed Class | Class 10 |
| Video Speed Class    | V60      |

|        |  |   |    |                 |
|--------|--|---|----|-----------------|
| 1 TB   |  |   |    | <b>00215495</b> |
|        |  | 5 | BK |                 |
| 512 GB |  |   |    | <b>00215494</b> |
|        |  | 5 | BK |                 |



## SanDisk

### SD Memory Card "Extreme Plus + 2 years RescuePRO Deluxe"

|        |  |    |    |                 |
|--------|--|----|----|-----------------|
| 256 GB |  |    |    | <b>00215401</b> |
|        |  | 5  | BK |                 |
| 128 GB |  |    |    | <b>00121593</b> |
|        |  | 25 | BK |                 |
| 64 GB  |  |    |    | <b>00121592</b> |
|        |  | 50 | BK |                 |



STORAGE MEDIA & ACCESSORIES



## SanDisk

### SDHC Extreme 32GB (V30/U3/ UHS-I/Cl.10/100MB/s)

- Ideal for compact cameras of all sizes
- Extreme fast transfer speeds up to 100 MB/s read and 60 MB/s write for flawless burst shootings
- 4K UHD and Full HD-ready with UHS Speed Class 3 (U3) and Video Speed Class 30 (V30)
- Remarkable recording performance with UHS Speed Class 1 (U1) und Class 10 für Videos in Full HD
- Waterproof, temperature-proof, X-ray proof, and shockproof

|       |          |
|-------|----------|
| 32 GB | 00215402 |
| 50 BK |          |



## SanDisk

### SD Memory Card "Extreme Pro (V90)", 300 MB/s

| UHS Standard         | UHS-II                      |
|----------------------|-----------------------------|
| Standard Speed Class | Class 10, UHS Speed Class 3 |
| Video Speed Class    | V90                         |

- Ideal for pros who demand high performance, professional cameras and high-resolution camcorders
- Super-fast write speeds of up to 260MB/s help rapidly clear buffer time to support continuous burst mode shooting and cinema-quality video recording
- Sustained V90 video speeds and UHS Speed Class 3 (U3) deliver cinema-quality 8K, 4K and Full HD video recording
- Extreme transfer speeds up to 300MB/s help achieve maximum post-production workflow efficiency
- Engineered for taking RAW format pictures and sequential burst mode photography
- Waterproof, temperature-proof, X-ray proof, and shockproof
- RescuePRO Deluxe data recovery software download offer

|        |          |
|--------|----------|
| 256 GB | 00215414 |
| 5 BK   |          |
| 128 GB | 00121506 |
| 25 BK  |          |
| 64 GB  | 00121505 |
| 50 BK  |          |
| 32 GB  | 00121504 |
| 50 BK  |          |



## SanDisk

### SD Memory Card "Extreme Pro + 2 years Res- cuePRO Deluxe", 300 MB/s

| UHS Standard         | UHS-3                       |
|----------------------|-----------------------------|
| Standard Speed Class | Class 10, UHS Speed Class 3 |
| Video Speed Class    | V30                         |

- Ideal for professional cameras and high-resolution camcorders
- Extreme fast transfer speeds up to 200 MB/s read and 90 MB/s write
- 4K UHD and Full HD-ready with UHS Speed Class 3 (U3) and Video Speed Class 30 (V30)
- Engineered to capture 4K UHD video, RAW format pictures and sequential burst mode photography
- Waterproof, temperature-proof, X-ray proof, and shockproof
- incl. Jewel Case to protect your card for storing and archiving
- RescuePRO Deluxe data recovery software download offer

|        |          |
|--------|----------|
| 128 GB | 00121596 |
| 25 BK  |          |



## SanDisk

### SD Memory Card "Extreme Pro (V60)", 280 MB/s

| UHS Standard         | UHS-II            |
|----------------------|-------------------|
| Standard Speed Class | UHS Speed Class 3 |
| Video Speed Class    | V60               |

- Ideal for professional cameras and high-resolution camcorders
- Extreme fast transfer speeds up to 280 MB/s read and 100 MB/s write
- 4K UHD and Full HD-ready with UHS Speed Class 3 (U3) and Video Speed Class 30 (V30)
- Engineered to capture 4K UHD video, RAW format pictures and sequential burst mode photography
- Waterproof, temperature-proof, X-ray proof, and shockproof
- incl. Jewel Case to protect your card for storing and archiving
- RescuePRO Deluxe data recovery software download offer

|        |          |
|--------|----------|
| 256 GB | 00215493 |
| 5 BK   |          |
| 128 GB | 00215492 |
| 25 BK  |          |
| 64 GB  | 00215491 |
| 50 BK  |          |



# Memory Cards



## SanDisk

**SD Memory Card**  
**"Extreme Pro + 2 years Res-  
 cuePRO Deluxe", 200 MB/s**

|                      |                             |
|----------------------|-----------------------------|
| UHS Standard         | UHS-3                       |
| Standard Speed Class | Class 10, UHS Speed Class 3 |
| Video Speed Class    | V30                         |

- Ideal for professional cameras and high-resolution camcorders
- Extreme fast transfer speeds up to 200 MB/s read and 90 MB/s write
- 4K UHD and Full HD-ready with UHS Speed Class 3 (U3) and Video Speed Class 30 (V30)
- Engineered to capture 4K UHD video, RAW format pictures and sequential burst mode photography
- Waterproof, temperature-proof, X-ray proof, and shockproof
- incl. Jewel Case to protect your card for storing and archiving
- RescuePRO Deluxe data recovery software download offer

## SanDisk

**SD Memory Card**  
**"Extreme Plus + 2 years Res-  
 cuePRO Deluxe", 190 MB/s**

|                      |                             |
|----------------------|-----------------------------|
| UHS Standard         | UHS-3                       |
| Standard Speed Class | Class 10, UHS Speed Class 3 |
| Video Speed Class    | V30                         |

- Ideal for professional cameras and high-resolution camcorders
- extreme fast transfer speeds up to 190 MB/s read and 90 MB/s write
- 4K UHD and Full HD-ready with UHS Speed Class 3 (U3) and Video Speed Class 30 (V30)
- Engineered to capture 4K UHD video and sequential burst mode photography
- Waterproof, temperature-proof, X-ray proof, and shockproof
- RescuePRO Deluxe data recovery software download offer

## SanDisk

**SD Memory Card**  
**"Extreme + 1 year Rescue-  
 PRO Deluxe", 180 MB/s**

|                      |                             |
|----------------------|-----------------------------|
| UHS Standard         | UHS-3                       |
| Standard Speed Class | Class 10, UHS Speed Class 3 |
| Video Speed Class    | V30                         |

- Ideal for compact cameras of all sizes
- Extreme fast transfer speeds up to 180 MB/s read and 90 MB/s write for flawless burst shootings
- 4K UHD and Full HD-ready with UHS Speed Class 3 (U3) and Video Speed Class 30 (V30)
- Remarkable recording performance with UHS Speed Class 1 (U1) und Class 10 für Videos in Full HD
- Waterproof, temperature-proof, X-ray proof, and shockproof

## SanDisk

**SD Memory Card**  
**"Extreme + 1 year Rescue-  
 PRO Deluxe", 170 MB/s**

|                      |                             |
|----------------------|-----------------------------|
| UHS Standard         | UHS-3                       |
| Standard Speed Class | Class 10, UHS Speed Class 3 |
| Video Speed Class    | V30                         |

- Ideal for compact cameras of all sizes
- Extreme fast transfer speeds up to 170 MB/s read and 80 MB/s write for flawless burst shootings
- 4K UHD and Full HD-ready with UHS Speed Class 3 (U3) and Video Speed Class 30 (V30)
- Remarkable recording performance with UHS Speed Class 1 (U1) und Class 10 für Videos in Full HD
- Waterproof, temperature-proof, X-ray proof, and shockproof



STORAGE MEDIA & ACCESSORIES

|        |  |    |    |                 |
|--------|--|----|----|-----------------|
| 1 TB   |  |    |    | <b>00121599</b> |
|        |  | 5  | BK |                 |
| 512 GB |  |    |    | <b>00121598</b> |
|        |  | 5  | BK |                 |
| 256 GB |  |    |    | <b>00121597</b> |
|        |  | 5  | BK |                 |
| 64 GB  |  |    |    | <b>00121595</b> |
|        |  | 50 | BK |                 |

|        |  |    |    |                 |
|--------|--|----|----|-----------------|
| 128 GB |  |    |    | <b>00121593</b> |
|        |  | 25 | BK |                 |

|        |  |    |    |                  |
|--------|--|----|----|------------------|
| 256 GB |  |    |    | <b>00121581</b>  |
|        |  | 5  | BK |                  |
| 128 GB |  |    |    | <b>00121580</b>  |
|        |  | 25 | BK |                  |
| 512 GB |  |    |    | <b>001215419</b> |
|        |  | 5  | BK |                  |

|       |  |    |    |                 |
|-------|--|----|----|-----------------|
| 64 GB |  |    |    | <b>00121579</b> |
|       |  | 50 | BK |                 |





## SanDisk

### SD Memory Card "Extreme Plus + 2 years RescuePRO Deluxe", 170 MB/s

| UHS Standard         | UHS-3                       |
|----------------------|-----------------------------|
| Standard Speed Class | Class 10, UHS Speed Class 3 |
| Video Speed Class    | V30                         |

- Ideal for professional cameras and high-resolution camcorders
- extreme fast transfer speeds up to 170 MB/s read and 80 MB/s write
- 4K UHD and Full HD-ready with UHS Speed Class 3 (U3) and Video Speed Class 30 (V30)
- Engineered to capture 4K UHD video and sequential burst mode photography
- Waterproof, temperature-proof, X-ray proof, and shockproof
- RescuePRO Deluxe data recovery software download offer

|       |          |
|-------|----------|
| 64 GB | 00121592 |
| 50 BK |          |



## SanDisk

### SD Memory Card "Ultra", 150 MB/s

| UHS Standard         | UHS-I    |
|----------------------|----------|
| Standard Speed Class | Class 10 |

- Ideal for compact cameras of all sizes
- Quick transfer speeds up to 150 MB/s
- Ultra Fast to take better pictures and Full HD videos
- Remarkable video recording performance with UHS Speed Class 1 (U1) and Class 10 rating for Full HD videos
- Waterproof, temperature-proof, X-ray proof, and shockproof

|        |          |
|--------|----------|
| 512 GB | 00215418 |
| 50 BK  |          |
| 256 GB | 00215417 |
| 50 BK  |          |



## SanDisk

### SD Memory Card "Ultra", 140 MB/s

| UHS Standard         | UHS-I    |
|----------------------|----------|
| Standard Speed Class | Class 10 |

- Ideal for compact cameras of all sizes
- Quick transfer speeds up to 140 MB/s
- Ultra Fast to take better pictures and Full HD videos
- Remarkable video recording performance with UHS Speed Class 1 (U1) and Class 10 rating for Full HD videos
- Waterproof, temperature-proof, X-ray proof, and shockproof

|        |          |
|--------|----------|
| 128 GB | 00215416 |
| 50 BK  |          |
| 64 GB  | 00215415 |
| 100 BK |          |



## SanDisk

### SD Memory Card "Ultra", 120 MB/s

| UHS Standard         | UHS-I                       |
|----------------------|-----------------------------|
| Standard Speed Class | Class 10, UHS Speed Class 1 |

- Ideal for compact cameras of all sizes
- Quick transfer speeds up to 120 MB/s
- Ultra Fast to take better pictures and Full HD videos
- Remarkable video recording performance with UHS Speed Class 1 (U1) and Class 10 rating for Full HD videos
- Waterproof, temperature-proof, X-ray proof, and shockproof

|        |          |
|--------|----------|
| 512 GB | 00121529 |
| 500 BK |          |
| 256 GB | 00186499 |
| 500 BK |          |
| 32 GB  | 00186496 |
| 100 BK |          |



# Memory Cards



## SanDisk

**SD Memory Card**  
**"Extreme Pro + 2 years Resc**  
**uePRO Deluxe", 100 MB/s**

|                      |                             |
|----------------------|-----------------------------|
| UHS Standard         | UHS-3                       |
| Standard Speed Class | Class 10, UHS Speed Class 3 |
| Video Speed Class    | V30                         |

- Ideal for professional cameras and high-resolution camcorders
- Extreme fast transfer speeds up to 10 MB/s read and 90 MB/s write
- 4K UHD and Full HD-ready with UHS Speed Class 3 (U3) and Video Speed Class 30 (V30)
- Engineered to capture 4K UHD video, RAW format pictures and sequential burst mode photography
- Waterproof, temperature-proof, X-ray proof, and shockproof
- incl. Jewel Case to protect your card for storing and archiving
- RescuePRO Deluxe data recovery software download offer

## SanDisk

**SDXC Elite Ultra Plus 128GB,**  
**Class 10, 80MB/s, + rescue**  
**pro**

|                      |          |
|----------------------|----------|
| Standard Speed Class | Class 10 |
|----------------------|----------|

## SanDisk

**SDXC Elite Ultra Plus 64GB,**  
**Class 10, 80MB/s, + rescue**  
**pro**

|                      |          |
|----------------------|----------|
| Standard Speed Class | Class 10 |
|----------------------|----------|

## SanDisk

**SDHC Elite Ultra Plus 32GB,**  
**Class 10, 80MB/s, + rescue**  
**pro**

|                      |          |
|----------------------|----------|
| Standard Speed Class | Class 10 |
|----------------------|----------|

|       |          |
|-------|----------|
| 32 GB | 00121594 |
| 50 BK |          |

|        |          |
|--------|----------|
| 128 GB | 00183515 |
| 50 BK  |          |

|        |          |
|--------|----------|
| 64 GB  | 00183514 |
| 100 BK |          |

|        |          |
|--------|----------|
| 32 GB  | 00183513 |
| 100 BK |          |

STORAGE MEDIA & ACCESSORIES

## CFexpress-Memorycard



CF Express PRO-CINEMA  
64GB, Type B, 1700MB/s  
Read, 1500MB/s Write

|  |  |   |    |          |
|--|--|---|----|----------|
|  |  |   |    | 00220059 |
|  |  | 5 | BK |          |



CF Express PRO-CINEMA  
320GB, Type B, 1700MB/s  
Read, 1500MB/s Write

|  |  |   |    |          |
|--|--|---|----|----------|
|  |  |   |    | 00220058 |
|  |  | 5 | BK |          |



CFexpress-Memorycard  
"Extreme Pro, Typ B"

|                         |           |
|-------------------------|-----------|
| Max. Data Transfer Rate | 1500 MB/s |
|-------------------------|-----------|

- High-speed, consistent recording and enhanced workflow efficiency
- Extremely fast read speeds of up to 1500MB/s and 800MB/s write speeds
- Smooth 4K Video Performance
- RAW 4K video with sustainable, low-latency performance
- The card is backwards-compatible with select XQD cameras that adopt firmware enabling Cfexpress
- RescuePRO Deluxe data recovery software download offer

|        |  |   |    |          |
|--------|--|---|----|----------|
| 512 GB |  |   |    | 00186487 |
|        |  | 5 | BK |          |
| 256 GB |  |   |    | 00186486 |
|        |  | 5 | BK |          |
| 128 GB |  |   |    | 00186485 |
|        |  | 5 | BK |          |
| 64 GB  |  |   |    | 00186484 |
|        |  | 5 | BK |          |

## CFast Memory Card



CFast Memory Card  
"Extreme Pro", 525 MB/s

|                |           |
|----------------|-----------|
| CFast Standard | CFast 2.0 |
|----------------|-----------|

- Designed for professional users of the broadcast, cinema and photography industry
- Suitable for cameras, camcorders und terminal devices with a CFast 2.0 slot
- Extremely high recording speed e.g. for cinema-quality 4k videos
- Data transfer: reads at up to 450MB/s and writes at up to 525MB/s
- Temperature range (operative/non-operative state): -20 C to +70 C
- Tested compatibility with cameras from the manufacturer "Blackmagic-design" & "ARRI"

|        |  |   |    |          |
|--------|--|---|----|----------|
| 512 GB |  |   |    | 00173409 |
|        |  | 5 | HB |          |
| 256 GB |  |   |    | 00173445 |
|        |  | 5 | HB |          |
| 128 GB |  |   |    | 00173408 |
|        |  | 5 | HB |          |
| 64 GB  |  |   |    | 00139791 |
|        |  | 5 | HB |          |



STORAGE MEDIA & ACCESSORIES

# Memory Cards

## CompactFlash Card



## microSD Memory Card

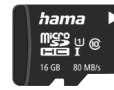

## SanDisk

### CompactFlash Card "Extreme Pro", 160 MB/s

- Especially recommendable for high-end digital cameras
- Suitable for terminal devices with a CompactFlash type I and II slot
- Extended, tested temperature range from -25°C up to +85°C
- Supports VPG-65 specification for video recording with a resolution of up to 4k
- Supports UDMA 7 mode (downward compatible)
- Water-repellent, shock-vibration tested housing
- Original brand name product from SanDisk, first equipment quality

## SanDisk

### CompactFlash Card "Extreme", 120 MB/s

- Especially recommendable for high-end digital cameras
- Suitable for terminal devices with a CompactFlash type I & II slot
- Designed to perform from -25°C to +85°C
- Supports UDMA 7 mode (downward compatible)
- Supports VPG-20 specification for video recording in full HD
- Water-repellent housing, backed by shock and vibration tests
- Genuine SanDisk branded item, OEM quality

## hama

### microSD Memory Card "Memory Fast + Adapter/Photo", 80 MB/s

|                      |                             |
|----------------------|-----------------------------|
| UHS Standard         | UHS-I                       |
| Standard Speed Class | Class 10, UHS Speed Class 1 |
| Video Speed Class    | V10                         |

- For real-time/broadcast recording; allows fast and direct data transfer between a memory card and a UHS-I capable terminal device
- micro SecureDigital Extended Capacity Card (microSDHC), complies with new SD 3.01 specifications
- Especially suited for real-time full HD video and 3D video recording
- Adapter for SD card format included

## hama

### microSD Memory Card „Memory Fast + Adapter / Photo, Narrow Pack.“, 80 MB/s

|                      |          |
|----------------------|----------|
| UHS Standard         | UHS-I    |
| Standard Speed Class | Class 10 |
| Video Speed Class    | V10      |

- For real-time/broadcast recording; allows fast and direct data transfer between a memory card and a UHS-I capable terminal device
- micro SecureDigital High Capacity Card (microSDHC), meets the new SD 3.01 standard
- Especially suitable for real-time full HD video and 3D video recording
- Incl. adapter to SD card format

|        |          |
|--------|----------|
| 256 GB | 00123863 |
| 10 HB  |          |
| 128 GB | 00123845 |
| 10 HB  |          |
| 64 GB  | 00123844 |
| 25 HB  |          |
| 32 GB  | 00123843 |
| 25 HB  |          |

|        |          |
|--------|----------|
| 128 GB | 00124095 |
| 25 BK  |          |
| 64 GB  | 00124094 |
| 25 BK  |          |
| 32 GB  | 00124093 |
| 25 BK  |          |

|        |          |
|--------|----------|
| 256 GB | 00124173 |
| 24 BK  |          |
| 128 GB | 00124160 |
| 24 BK  |          |
| 64 GB  | 00124152 |
| 24 BK  |          |
| 32 GB  | 00124151 |
| 24 BK  |          |
| 16 GB  | 00124150 |
| 24 BK  |          |

|       |          |
|-------|----------|
| 32 GB | 00213114 |
| 32 BK |          |
| 16 GB | 00213113 |
| 32 BK |          |

STORAGE MEDIA & ACCESSORIES

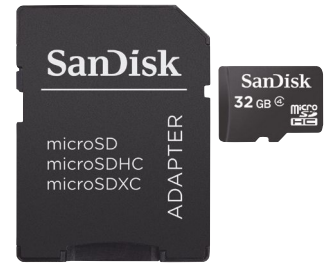

## hama

### microSD Memory Card "Memory Pro 4K + Adapter/ Photo", 80 MB/s

|                      |                   |
|----------------------|-------------------|
| UHS Standard         | UHS-I             |
| Standard Speed Class | UHS Speed Class 3 |
| Video Speed Class    | V30               |

- Allows perfect, high-resolution 4k video recordings with a guaranteed minimum write speed of 30 MB/sec.
- micro SecureDigital Extended Capacity Card (microSDXC), complies with new SD 3.01 specifications
- Especially suited for 4k cinema video, real time full HD video and 3D video recordings
- Comes with an adapter for SD card format

## hama

### microSD Memory Card „Memory Pro 4K + adapter / photo, narrow pack.“, 80 MB/s

|                      |                   |
|----------------------|-------------------|
| UHS Standard         | UHS-3             |
| Standard Speed Class | UHS Speed Class 3 |
| Video Speed Class    | V30               |

- Allows perfect, high-resolution 4k video recordings with a guaranteed minimum write speed of 30 MB/sec.
- micro SecureDigital Extended Capacity Card (microSDXC), meets new SD 3.01 standard
- Especially suitable for 4K cinema video, real-time full-HD video and 3D video recording
- Incl. adapter to SD card format

## hama

### microSD Memory Card "Memory Base + Adapter/ Photo", 22 MB/s

|                      |          |
|----------------------|----------|
| UHS Standard         | UHS-I    |
| Standard Speed Class | Class 10 |

- For real-time/broadcast recording; allows fast and direct data transfer between a memory card and a UHS-I capable terminal device
- micro SecureDigital Extended Capacity Card (microSDXC), meets new SD 3.0 standard
- especially suited to real-time full HD video and 3D video recording
- Incl. adapter to SD card format

## SanDisk

### microSD Memory Card "Blue Label + SD Adapter Photo"

|                      |         |
|----------------------|---------|
| Standard Speed Class | Class 4 |
|----------------------|---------|

- Ideal for mobile phones, cameras and tablets
- Easy and affordable memory expansion
- More space for fotos, videos and music
- Included SD adapter for use in cameras
- Waterproof, temperature-proof, X-ray proof, and shockproof

|        |          |
|--------|----------|
| 128 GB | 00181002 |
| 24 BK  |          |
| 64 GB  | 00123982 |
| 24 BK  |          |
| 32 GB  | 00123981 |
| 24 BK  |          |
| 16 GB  | 00123980 |
| 24 BK  |          |

|        |          |
|--------|----------|
| 128 GB | 00213116 |
| 32 BK  |          |
| 64 GB  | 00213115 |
| 32 BK  |          |

|       |          |
|-------|----------|
| 64 GB | 00108077 |
| 24 BK |          |
| 32 GB | 00108089 |
| 24 BK |          |
| 16 GB | 00108088 |
| 24 BK |          |

|        |          |
|--------|----------|
| 32 GB  | 00108097 |
| 100 BK |          |



# Memory Cards



**SanDisk**

microSD Memory Card  
"Blue Label + SD Adapter  
Mobile"

|                      |         |
|----------------------|---------|
| Standard Speed Class | Class 4 |
|----------------------|---------|

- Ideal for mobile phones, cameras and tablets
- Easy and affordable memory expansion
- More space for fotos, videos and music
- Included SD adapter for use in cameras
- Waterproof, temperature-proof, X-ray proof, and shockproof

|        |          |
|--------|----------|
| 32 GB  | 00114758 |
| 100 BK |          |



**SanDisk**

microSD Memory Card  
"Blue Label Mobile"

|                      |         |
|----------------------|---------|
| Standard Speed Class | Class 4 |
|----------------------|---------|

- Ideal for mobile phones, cameras and tablets
- Easy and affordable memory expansion
- More space for fotos, videos and music
- Waterproof, temperature-proof, X-ray proof, and shockproof

|        |          |
|--------|----------|
| 32 GB  | 00104374 |
| 100 BK |          |



**SanDisk**

microSD Memory Card  
"Ultra + Adapter, 2er-Set"

|                      |          |
|----------------------|----------|
| UHS Standard         | UHS-I    |
| Standard Speed Class | Class 10 |

|        |          |
|--------|----------|
| 128 GB | 00215429 |
| 50 BK  |          |
| 64 GB  | 00215428 |
| 50 BK  |          |

**SanDisk**

microSDXC High Endurance  
Monitoring 512GB, Class 10,  
100MB/s + SD-Adapter

|       |          |
|-------|----------|
|       | 00220051 |
| 10 BK |          |



STORAGE MEDIA & ACCESSORIES



## SanDisk

microSDXC Ultra 64GB  
(140MB/s A1 Cl. 10 UHS-I) +  
Adapter „Tablet“

- Ideal for tablet computers
- Ultra fast Transfer speeds of up to 140MB/s
- Exceptional video recording performance with UHS Speed Class 1 (U1) and Class 10 rating for Full HD videos
- Included SD adapter
- Waterproof, temperature-proof, X-ray proof, and shockproof

|  |  |     |    |          |
|--|--|-----|----|----------|
|  |  |     |    | 00215472 |
|  |  | 100 | BK |          |



## SanDisk

microSD Memory Card „Extreme Plus + Adapter, 2 years RescuePRO Deluxe“, 200 MB/s

| UHS Standard         | UHS-3             |
|----------------------|-------------------|
| Standard Speed Class | UHS Speed Class 3 |
| Video Speed Class    | V30               |

- Ideal for Android smartphones, action cameras and drones
- Extreme fast transfer speeds up to 200 MB/s read and 90 MB/s write
- 4K UHD and Full HD-ready with UHS Speed Class 3 (U3) and Video Speed Class 30 (V30)
- A2 rating for faster loading of apps and improved performance
- Waterproof, temperature-proof, X-ray proof, and shockproof
- Included SD adapter for use in cameras
- RescuePRO Deluxe data recovery software download offer

|        |  |    |    |          |
|--------|--|----|----|----------|
| 256 GB |  |    |    | 00214502 |
|        |  | 25 | BK |          |
| 128 GB |  |    |    | 00214501 |
|        |  | 25 | BK |          |
| 64 GB  |  |    |    | 00214500 |
|        |  | 50 | BK |          |



## SanDisk

microSD Memory Card „Extreme Pro + Adapter, 2 years RescuePRO Deluxe“, 200 MB/s

| UHS Standard         | UHS-3             |
|----------------------|-------------------|
| Standard Speed Class | UHS Speed Class 3 |
| Video Speed Class    | V30               |

- Ideal for Android smartphones, action cameras and drones
- Extreme fast transfer speeds up to 200MB/s read and 140MB/s write
- 4K UHD and Full HD-ready with UHS Speed Class 3 (U3) and Video Speed Class 30 (V30)
- A2 rating for faster loading of apps and improved performance
- Waterproof, temperature-proof, X-ray proof, and shockproof
- Included SD adapter for use in cameras
- RescuePRO Deluxe data recovery software download offer

|        |  |    |    |          |
|--------|--|----|----|----------|
| 1 TB   |  |    |    | 00214508 |
|        |  | 5  | BK |          |
| 512 GB |  |    |    | 00214507 |
|        |  | 5  | BK |          |
| 400 GB |  |    |    | 00214506 |
|        |  | 5  | BK |          |
| 256 GB |  |    |    | 00214505 |
|        |  | 5  | BK |          |
| 128 GB |  |    |    | 00214504 |
|        |  | 25 | BK |          |
| 64 GB  |  |    |    | 00214503 |
|        |  | 50 | BK |          |



## SanDisk

microSD Memory Card „Extreme, Cams&Drones, +Adapter, 1 year RescuePRO Deluxe“, 190 MB/s

| UHS Standard         | UHS-3                       |
|----------------------|-----------------------------|
| Standard Speed Class | Class 10, UHS Speed Class 3 |
| Video Speed Class    | V30                         |

- Ideal for action cameras and drones
- Extreme fast transfer speeds up to 190MB/s read and 90MB/s write
- 4K UHD and Full HD-ready with UHS Speed Class 3 (U3) and Video Speed Class 30 (V30)
- A2 rating for faster loading of apps and improved performance
- Waterproof, temperature-proof (-25°C to 85°C), X-ray proof, and shockproof
- Included SD adapter for use in cameras
- RescuePRO Deluxe data recovery software download offer

|        |  |    |    |          |
|--------|--|----|----|----------|
| 128 GB |  |    |    | 00214510 |
|        |  | 25 | BK |          |



STORAGE MEDIA & ACCESSORIES

# Memory Cards



## SanDisk

microSD Memory Card „Extreme, Mobile Gaming, 1 Jahr RescuePRO Deluxe“, 190 MB/s

| UHS Standard         | UHS-I                       |
|----------------------|-----------------------------|
| Standard Speed Class | Class 10, UHS Speed Class 3 |
| Video Speed Class    | V30                         |

- Ideal for Android smartphones and tablets
- Extreme fast transfer speeds up to 190 MB/s read and 90 MB/s write
- UHS Speed Class 3 (U3) and Video Speed Class 30 (V30) to support demanding AAA/3D/VR game graphics and 4K UHD video
- A2 rating for faster loading of apps and improved performance
- Waterproof, temperature-proof, X-ray proof, and shockproof
- RescuePRO Deluxe data recovery software download offer

## SanDisk

microSD Memory Card „Extreme + Adapter, 1 year RescuePRO Deluxe“, 190 MB/s

| UHS Standard         | UHS-3             |
|----------------------|-------------------|
| Standard Speed Class | UHS Speed Class 3 |
| Video Speed Class    | V30               |

- Ideal for Android smartphones, action cameras and drones
- Extreme fast transfer speeds up to 190MB/s read and 130MB/s write
- 4K UHD and Full HD-ready with UHS Speed Class 3 (U3) and Video Speed Class 30 (V30)
- A2 rating for faster loading of apps and improved performance
- Waterproof, temperature-proof, X-ray proof, and shockproof
- Included SD™ adapter for use in cameras
- RescuePRO Deluxe data recovery software download offer

## SanDisk

microSD Memory Card „Extreme, Mobile Gaming, 1 Jahr RescuePRO Deluxe“, 170 MB/s

| UHS Standard         | UHS-I                       |
|----------------------|-----------------------------|
| Standard Speed Class | Class 10, UHS Speed Class 3 |
| Video Speed Class    | V30                         |

- Ideal for Android smartphones and tablets
- Extreme fast transfer speeds up to 170 MB/s read and 80 MB/s write
- UHS Speed Class 3 (U3) and Video Speed Class 30 (V30) to support demanding AAA/3D/VR game graphics and 4K UHD video
- A2 rating for faster loading of apps and improved performance
- Waterproof, temperature-proof, X-ray proof, and shockproof
- RescuePRO Deluxe data recovery software download offer

## SanDisk

microSD Memory Card "Extreme + Adapter, 1 year RescuePRO Deluxe", 170 MB/s

| UHS Standard         | UHS-3             |
|----------------------|-------------------|
| Standard Speed Class | UHS Speed Class 3 |
| Video Speed Class    | V30               |

- Ideal for Android smartphones, action cameras and drones
- Extreme fast transfer speeds up to 170MB/s read and 80MB/s write
- 4K UHD and Full HD-ready with UHS Speed Class 3 (U3) and Video Speed Class 30 (V30)
- A2 rating for faster loading of apps and improved performance
- Waterproof, temperature-proof, X-ray proof, and shockproof
- Included SD™ adapter for use in cameras
- RescuePRO Deluxe data recovery software download offer

|        |          |
|--------|----------|
| 256 GB | 00121584 |
| 25 BK  |          |
| 128 GB | 00121583 |
| 25 BK  |          |

|        |          |
|--------|----------|
| 1 TB   | 00121590 |
| 10 BK  |          |
| 512 GB | 00121589 |
| 25 BK  |          |
| 256 GB | 00121587 |
| 25 BK  |          |
| 128 GB | 00121586 |
| 25 BK  |          |

|       |          |
|-------|----------|
| 64 GB | 00121582 |
| 50 BK |          |

|       |          |
|-------|----------|
| 64 GB | 00121585 |
| 50 BK |          |

STORAGE MEDIA & ACCESSORIES





## SanDisk

microSD Memory Card "Extreme Pro (mSD UHS-I + Adapter Mobile)", 170 MB/s

| UHS Standard         | UHS-I             |
|----------------------|-------------------|
| Standard Speed Class | UHS Speed Class 3 |
| Video Speed Class    | V30               |

- Ideal for Android smartphones, action cameras and drones
- Extreme fast transfer speeds up to 170MB/s read and 90MB/s write
- 4K UHD and Full HD-ready with UHS Speed Class 3 (U3) and Video Speed Class 30 (V30)
- A2 rating for faster loading of apps and improved performance
- Waterproof, temperature-proof, X-ray proof, and shockproof
- Included SD adapter for use in cameras
- RescuePRO Deluxe data recovery software download offer

|      |          |
|------|----------|
| 1 TB | 00183572 |
| 5 BK |          |



## SanDisk

microSD Memory Card „Extreme, Cams&Drones, +Adapter, 1 year RescuePRO Deluxe“, 170 MB/s

| UHS Standard         | UHS-3             |
|----------------------|-------------------|
| Standard Speed Class | UHS Speed Class 3 |
| Video Speed Class    | V30               |

- Ideal for action cameras and drones
- Extreme fast transfer speeds up to 170MB/s read and 80MB/s write
- 4K UHD and Full HD-ready with UHS Speed Class 3 (U3) and Video Speed Class 30 (V30)
- A2 rating for faster loading of apps and improved performance
- Waterproof, temperature-proof (-25°C to 85°C), X-ray proof, and shockproof
- Included SD adapter for use in cameras
- RescuePRO Deluxe data recovery software download offer

|       |          |
|-------|----------|
| 64 GB | 00214509 |
| 50 BK |          |



## SanDisk

microSD Memory Card "Ultra + Adapter Mobile", 150 MB/s

| UHS Standard         | UHS-I    |
|----------------------|----------|
| Standard Speed Class | Class 10 |

- Ideal for Android smartphones and tablet computers
- Ultra fast Transfer speeds of up to 150MB/s
- exceptional video recording performance with UHS Speed Class 1 (U1) and Class 10 rating for Full HD videos
- A1 rating for faster loading of apps and improved performance
- Included SD adapter for use in cameras
- Waterproof, temperature-proof, X-ray proof, and shockproof

|        |          |
|--------|----------|
| 1 TB   | 00215425 |
| 25 BK  |          |
| 512 GB | 00215424 |
| 25 BK  |          |
| 256 GB | 00215423 |
| 50 BK  |          |

## SanDisk

microSD Memory Card "Ultra Mobile", 150 MB/s

| UHS Standard         | UHS-I    |
|----------------------|----------|
| Standard Speed Class | Class 10 |

- Ideal for Android smartphones and tablet computers
- Ultra fast Transfer speeds of up to 150MB/s
- exceptional video recording performance with UHS Speed Class 1 (U1) and Class 10 rating for Full HD videos
- A1 rating for faster loading of apps and improved performance
- Included SD adapter for use in cameras
- Waterproof, temperature-proof, X-ray proof, and shockproof

|        |          |
|--------|----------|
| 1,5 TB | 00220078 |
| 25 BK  |          |



STORAGE MEDIA & ACCESSORIES

# Memory Cards



## SanDisk

### microSD Memory Card "Ultra + Adapter Mobile", 140 MB/s

| UHS Standard         | UHS-I    |
|----------------------|----------|
| Standard Speed Class | Class 10 |

- Ideal for Android smartphones and tablet computers
- Ultra fast Transfer speeds of up to 140MB/s
- exceptional video recording performance with UHS Speed Class 1 (U1) and Class 10 rating for Full HD videos
- A1 rating for faster loading of apps and improved performance
- Included SD adapter for use in cameras
- Waterproof, temperature-proof, X-ray proof, and shockproof

|        |  |     |    |                 |
|--------|--|-----|----|-----------------|
| 128 GB |  |     |    | <b>00215422</b> |
|        |  | 100 | BK |                 |
| 64 GB  |  |     |    | <b>00215421</b> |
|        |  | 100 | BK |                 |

## SanDisk

### microSD Memory Card "Ultra + Adapter", 140 MB/s

| UHS Standard         | UHS-I    |
|----------------------|----------|
| Standard Speed Class | Class 10 |

- Ideal for high quality digital cameras
- Ultra fast Transfer speeds of up to 140MB/s
- exceptional video recording performance with UHS Speed Class 1 (U1) and Class 10 rating for Full HD videos
- A1 rating for faster loading of apps and improved performance
- Included SD adapter for use in cameras
- Waterproof, temperature-proof, X-ray proof, and shockproof

|        |  |     |    |                 |
|--------|--|-----|----|-----------------|
| 128 GB |  |     |    | <b>00215427</b> |
|        |  | 100 | BK |                 |
| 64 GB  |  |     |    | <b>00215426</b> |
|        |  | 100 | BK |                 |

## SanDisk

### microSD Memory Card "Ultra + SD-Adapter for Chromebooks", 140 MB/s

| Standard Speed Class | Class 10 |
|----------------------|----------|
|----------------------|----------|

- Tested and certified for seamless compatibility with Chromebooks
- Quick transfer speeds up to 140MB/s
- A1 rating for faster loading of apps and improved performance
- Exceptional video recording performance with UHS Speed Class 1 (U1) and Class 10 rating for Full HD videos
- Included SD adapter for use in cameras
- Waterproof, temperature-proof, X-ray proof, and shockproof

|        |  |     |    |                 |
|--------|--|-----|----|-----------------|
| 512 GB |  |     |    | <b>00215469</b> |
|        |  | 25  | BK |                 |
| 256 GB |  |     |    | <b>00215471</b> |
|        |  | 50  | BK |                 |
| 128 GB |  |     |    | <b>00215470</b> |
|        |  | 100 | BK |                 |
| 64 GB  |  |     |    | <b>00215468</b> |
|        |  | 100 | BK |                 |

## SanDisk

### microSD Memory Card "Ultra + Adapter/Chrome- book", 120 MB/s

| UHS Standard         | UHS-I    |
|----------------------|----------|
| Standard Speed Class | Class 10 |

- Tested and certified for seamless compatibility with Chromebooks
- Quick transfer speeds up to 120MB/s
- A1 rating for faster loading of apps and improved performance
- Exceptional video recording performance with UHS Speed Class 1 (U1) and Class 10 rating for Full HD videos
- Included SD adapter for use in cameras
- Waterproof, temperature-proof, X-ray proof, and shockproof

|        |  |     |    |                 |
|--------|--|-----|----|-----------------|
| 128 GB |  |     |    | <b>00186540</b> |
|        |  | 100 | BK |                 |

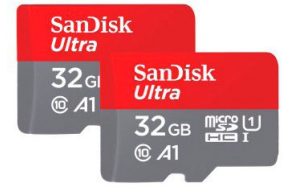
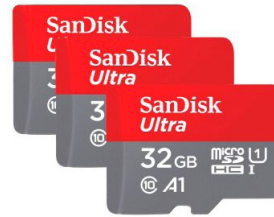
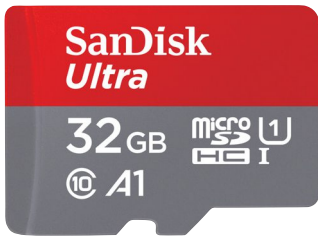

## SanDisk

microSD Memory Card  
"Ultra + Adapter/Imaging",  
120 MB/s

| UHS Standard         | UHS-I                       |
|----------------------|-----------------------------|
| Standard Speed Class | Class 10, UHS Speed Class 1 |

- Ideal for high quality digital cameras
- Ultra fast Transfer speeds of up to 120MB/s
- exceptional video recording performance with UHS Speed Class 1 (U1) and Class 10 rating for Full HD videos
- A1 rating for faster loading of apps and improved performance
- Included SD adapter for use in cameras
- Waterproof, temperature-proof, X-ray proof, and shockproof

|        |          |
|--------|----------|
| 32 GB  | 00186500 |
| 100 BK |          |

## SanDisk

microSD Memory Card  
"Ultra + Adapter/Mobile",  
120 MB/s

| UHS Standard         | UHS-I                       |
|----------------------|-----------------------------|
| Standard Speed Class | Class 10, UHS Speed Class 1 |

- Ideal for Android smartphones and tablet computers
- Ultra fast Transfer speeds of up to 120MB/s
- exceptional video recording performance with UHS Speed Class 1 (U1) and Class 10 rating for Full HD videos
- A1 rating for faster loading of apps and improved performance
- Included SD adapter for use in cameras
- Waterproof, temperature-proof, X-ray proof, and shockproof

|        |          |
|--------|----------|
| 256 GB | 00186507 |
| 50 BK  |          |
| 32 GB  | 00186503 |
| 100 BK |          |

## SanDisk

SDHC Ultra 32GB (Class 10/  
UHS-I/120MB/s), 3 Pieces

| UHS Standard         | UHS-I    |
|----------------------|----------|
| Standard Speed Class | Class 10 |

|        |          |
|--------|----------|
| 32 GB  | 00186531 |
| 100 BK |          |

## SanDisk

SanDisk Ultra® 32GB microS-  
DHC+ SD Adapter 120MB/s  
A1 Class 10 UHS-I - 2-Pa

| UHS Standard         | UHS-I    |
|----------------------|----------|
| Standard Speed Class | Class 10 |

|       |          |
|-------|----------|
| 32 GB | 00186521 |
| 50 BK |          |



# Memory Cards

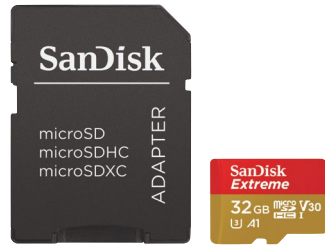

## SanDisk

microSDHC Ultra 32GB (A1/  
UHS-1/CI.10/120MB/s) +  
Adapter, „Tablet“

|                      |          |
|----------------------|----------|
| UHS Standard         | UHS-I    |
| Standard Speed Class | Class 10 |

## SanDisk

microSD Memory Card  
"Extreme (mSD + Adapter  
Mobile)", 100 MB/s

|                      |                             |
|----------------------|-----------------------------|
| UHS Standard         | UHS-I                       |
| Standard Speed Class | Class 10, UHS Speed Class 3 |
| Video Speed Class    | V30                         |

- Ideal for Android smartphones, action cameras and drones
- Extreme fast transfer speeds up to 100MB/s read and 60MB/s write
- 4K UHD and Full HD-ready with UHS Speed Class 3 (U3) and Video Speed Class 30 (V30)
- A2 rating for faster loading of apps and improved performance
- Waterproof, temperature-proof, X-ray proof, and shockproof
- Included SD adapter for use in cameras
- RescuePRO Deluxe data recovery software download offer

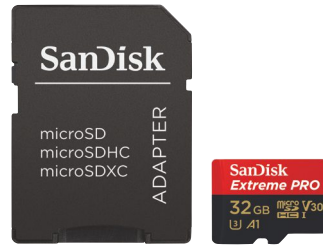

## SanDisk

microSD Memory Card  
"Extreme Pro V30 + Adapter/  
Mobile", 100 MB/s

|                      |                             |
|----------------------|-----------------------------|
| UHS Standard         | UHS-I                       |
| Standard Speed Class | Class 10, UHS Speed Class 3 |
| Video Speed Class    | V30                         |

- Ideal for Android smartphones, action cameras and drones
- Extreme fast transfer speeds up to 100MB/s read and 90MB/s write
- 4K UHD and Full HD-ready with UHS Speed Class 3 (U3) and Video Speed Class 30 (V30)
- A1 rating for faster loading of apps and improved performance
- Waterproof, temperature-proof, X-ray proof, and shockproof
- Included SD adapter for use in cameras
- RescuePRO Deluxe data recovery software download offer

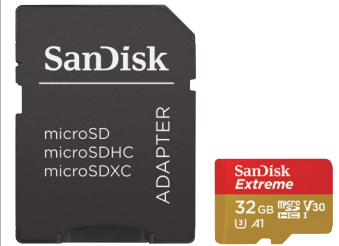

## SanDisk

microSD Memory Card  
"Extreme V30 + Adapter/  
Action Cam", 100 MB/s

|                      |                             |
|----------------------|-----------------------------|
| UHS Standard         | UHS-I                       |
| Standard Speed Class | Class 10, UHS Speed Class 3 |
| Video Speed Class    | V30                         |

- Ideal for action cameras and drones
- Extreme fast transfer speeds up to 100MB/s read and 60MB/s write
- 4K UHD and Full HD-ready with UHS Speed Class 3 (U3) and Video Speed Class 30 (V30)
- A2 rating for faster loading of apps and improved performance
- Waterproof, temperature-proof (-25°C to 85°C), X-ray proof, and shockproof
- Included SD adapter for use in cameras
- RescuePRO Deluxe data recovery software download offer

|        |          |
|--------|----------|
| 32 GB  | 00220045 |
| 100 BK |          |

|       |          |
|-------|----------|
| 32 GB | 00173420 |
| 50 BK |          |

|       |          |
|-------|----------|
| 32 GB | 00173427 |
| 50 BK |          |

|       |          |
|-------|----------|
| 32 GB | 00173417 |
| 50 BK |          |



**SanDisk**

**microSD Memory Card  
"High Endurance + SD-Adapter", 100 MB/s**

|                      |          |
|----------------------|----------|
| UHS Standard         | UHS-3    |
| Standard Speed Class | Class 10 |
| Video Speed Class    | V30      |

- Perfect for Dash Cams and home monitoring systems
- Designed for high endurance monitoring with up to 40 MB/s, record up to 120.000 hours with no worries
- 4K UHD and Full HD recordings with UHS Speed Class 3 (U3), Video Speed Class 30 (V30) and Class 10
- Quickly transfer or back up videos to computer with read speeds up to 100MB/s
- With an Adapter (included) also suitable for devices with an SDHC/XC slot
- Waterproof, temperature-proof, X-ray proof, and shockproof

|        |          |
|--------|----------|
| 256 GB | 00186475 |
| 25 BK  |          |
| 128 GB | 00186474 |
| 25 BK  |          |
| 64 GB  | 00186473 |
| 25 BK  |          |
| 32 GB  | 00186472 |
| 25 BK  |          |



**SanDisk**

**microSD Memory Card  
"High Endurance Monitoring + SD-Adapter", 100 MB/s**

|                      |          |
|----------------------|----------|
| UHS Standard         | UHS-3    |
| Standard Speed Class | Class 10 |

- Designed for high endurance so you can record for up to 20.000 hours with no worries
- 4K UHD and Full HD recordings with UHS Speed Class 3 (U3), Video Speed Class 30 (V30) and Class 10
- Quickly transfer or back up videos to computer with read speeds up to 100MB/s
- with an Adapter (included) also suitable for terminal devices with an SDHC slot
- Waterproof, temperature-proof, X-ray proof, and shockproof

|        |          |
|--------|----------|
| 256 GB | 00183568 |
| 25 BK  |          |
| 128 GB | 00183567 |
| 25 BK  |          |
| 64 GB  | 00183566 |
| 25 BK  |          |
| 32 GB  | 00183565 |
| 25 BK  |          |



**SanDisk**

**microSD Memory Card  
"Ultra + Adapter, Tablet", 100 MB/s**

|                      |          |
|----------------------|----------|
| UHS Standard         | UHS-I    |
| Standard Speed Class | Class 10 |

- Ideal for tablet computers
- Ultra fast Transfer speeds of up to 120MB/s
- Exceptional video recording performance with UHS Speed Class 1 (U1) and Class 10 rating for Full HD videos
- Included SD adapter
- Waterproof, temperature-proof, X-ray proof, and shockproof

|        |          |
|--------|----------|
| 512 GB | 00215485 |
| 25 BK  |          |
| 256 GB | 00215484 |
| 50 BK  |          |
| 128 GB | 00215483 |
| 100 BK |          |
| 64 GB  | 00215482 |
| 100 BK |          |
| 32 GB  | 00215481 |
| 100 BK |          |



**SanDisk**

**microSD Memory Card  
"Ultra + Adapter/Tablet", 100 MB/s**

|                      |                             |
|----------------------|-----------------------------|
| UHS Standard         | UHS-I                       |
| Standard Speed Class | Class 10, UHS Speed Class 1 |

- Ideal for tablet computers
- Ultra fast Transfer speeds of up to 100MB/s
- Exceptional video recording performance with UHS Speed Class 1 (U1) and Class 10 rating for Full HD videos
- Included SD adapter
- Waterproof, temperature-proof, X-ray proof, and shockproof

|        |          |
|--------|----------|
| 128 GB | 00186527 |
| 100 BK |          |



STORAGE MEDIA & ACCESSORIES

# Memory Cards



**SanDisk**

microSD Memory Card  
"Ultra Lite", 100 MB/s

|                      |          |
|----------------------|----------|
| UHS Standard         | UHS-I    |
| Standard Speed Class | Class 10 |



**SanDisk**

microSD Memory Card  
"Ultra", 100 MB/s

|                      |          |
|----------------------|----------|
| UHS Standard         | UHS-I    |
| Standard Speed Class | Class 10 |

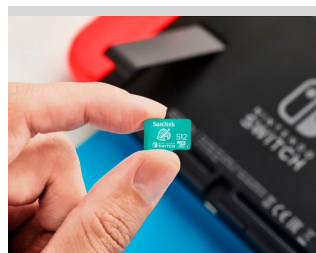

**SanDisk**

microSDXC Extreme 512GB  
(A1/V30/U3/C10/R100/W90)  
for Nintendo Switch

|                      |          |
|----------------------|----------|
| UHS Standard         | UHS-I    |
| Standard Speed Class | Class 10 |
| Video Speed Class    | V30      |

- Designed, tested and approved for memory expansion of Nintendo Switch game system
- Consistent high performance so you can load games fast with read speed up to 100MB/s
- Download games faster with write speed up to 90 MB/s
- Incredible speeds in a microSD card officially licensed for the Nintendo Switch system
- Add more memory for more games, screenshots and video captures
- No longer carry multiple game cards, download games directly to a single memory card and play anytime, anywhere



**SanDisk**

microSDXC Extr 256GB (A1/  
V30/U3/C10/R100/W90) Fort-  
nite, Cuddle Team Leader

|                      |                             |
|----------------------|-----------------------------|
| UHS Standard         | UHS-I                       |
| Standard Speed Class | Class 10, UHS Speed Class 3 |
| Video Speed Class    | V30                         |

- Designed, tested and approved for memory expansion of Nintendo Switch game system
- Consistent high performance so you can load games fast with read speed up to 100MB/s
- Download games faster with write speed up to 90 MB/s
- Incredible speeds in a microSD card officially licensed for the Nintendo Switch system
- Add more memory for more games, screenshots and video captures
- No longer carry multiple game cards, download games directly to a single memory card and play anytime, anywhere

|        |          |
|--------|----------|
| 256 GB | 00121525 |
| 50 BK  |          |

|        |          |
|--------|----------|
| 64 GB  | 00186537 |
| 100 BK |          |
| 32 GB  | 00186536 |
| 100 BK |          |

|        |          |
|--------|----------|
| 512 GB | 00186522 |
| 25 BK  |          |

|        |          |
|--------|----------|
| 256 GB | 00215473 |
| 25 BK  |          |

STORAGE MEDIA & ACCESSORIES



## SanDisk

**microSDXC Extreme 256GB (A1/ V30/ U3/ C10/ R100/ W90) for Nintendo Switch**

| UHS Standard         | UHS-3    |
|----------------------|----------|
| Standard Speed Class | Class 10 |
| Video Speed Class    | V30      |

- incredible speeds in a microSD card officially licensed for the Nintendo Switch system
- consistent high performance so you can load games fast with read speed up to 100MB/s
- download games faster with write speed up to 90 MB/s
- add more memory for more games, screenshots and video captures
- no longer carry multiple game cards, download games directly to a single memory card and play anytime, anywhere
- genuine SanDisk branded item, OEM quality

|        |                 |
|--------|-----------------|
| 256 GB | <b>00183573</b> |
| 25 BK  |                 |



## SanDisk

**microSDXC Extr 128GB (U3/ UHS-I/CL.10/R100/W60) Fort-nite, Skull Trooper**

| UHS Standard         | UHS-I                       |
|----------------------|-----------------------------|
| Standard Speed Class | Class 10, UHS Speed Class 3 |
| Video Speed Class    | V30                         |

- Designed, tested and approved for memory expansion of Nintendo Switch game system
- Consistent high performance so you can load games fast with read speed up to 100MB/s
- Download games faster with write speed up to 90 MB/s
- Incredible speeds in a microSD card officially licensed for the Nintendo Switch system
- Add more memory for more games, screenshots and video captures
- No longer carry multiple game cards, download games directly to a single memory card and play anytime, anywhere

|        |                 |
|--------|-----------------|
| 128 GB | <b>00215474</b> |
| 25 BK  |                 |



## SanDisk

**microSDXC Extreme 128GB (U3/UHS-I/CL.10/R100/W90) for Nintendo Switch**

| UHS Standard         | UHS-I    |
|----------------------|----------|
| Standard Speed Class | Class 10 |

- Designed, tested and approved for memory expansion of Nintendo Switch game system
- Consistent high performance so you can load games fast with read speed up to 100MB/s
- Download games faster with write speed up to 90MB/s
- Incredible speeds in a microSD card officially licensed for the Nintendo Switch system
- Add more memory for more games, screenshots and video captures
- No longer carry multiple game cards, download games directly to a single memory card and play anytime, anywhere

|        |                 |
|--------|-----------------|
| 128 GB | <b>00183552</b> |
| 25 BK  |                 |



## SanDisk

**microSDXC Extreme 128GB UHS for Nintendo Switch Apex Legends**

| UHS Standard         | UHS-I                       |
|----------------------|-----------------------------|
| Standard Speed Class | Class 10, UHS Speed Class 3 |
| Video Speed Class    | V30                         |

- Designed, tested and approved for memory expansion of Nintendo Switch game system
- Consistent high performance so you can load games fast with read speed up to 100MB/s
- Download games faster with write speed up to 90 MB/s
- Incredible speeds in a microSD card officially licensed for the Nintendo Switch system
- Add more memory for more games, screenshots and video captures
- No longer carry multiple game cards, download games directly to a single memory card and play anytime, anywhere

|        |                 |
|--------|-----------------|
| 128 GB | <b>00186590</b> |
| 25 BK  |                 |



# Memory Cards



## SanDisk

microSDXC Ultra 128GB  
(UHS-I/CI.10/100MB/s)

|                      |          |
|----------------------|----------|
| UHS Standard         | UHS-I    |
| Standard Speed Class | Class 10 |

## SanDisk

microSDXC Extreme 64GB  
(U3/UHS-I/CI.10/R100/W60)  
for Nintendo Switch

|                      |          |
|----------------------|----------|
| UHS Standard         | UHS-I    |
| Standard Speed Class | Class 10 |

- Designed, tested and approved for memory expansion of Nintendo Switch game system
- Consistent high performance so you can load games fast with read speed up to 100MB/s
- Download games faster with write speed up to 60MB/s
- Incredible speeds in a microSD card officially licensed for the Nintendo Switch system
- Add more memory for more games, screenshots and video captures
- No longer carry multiple game cards, download games directly to a single memory card and play anytime, anywhere

## SanDisk

microSD Memory Card  
"Extreme for Mobile Ga-  
ming", 100 MB/s

|                      |                   |
|----------------------|-------------------|
| UHS Standard         | UHS-I             |
| Standard Speed Class | UHS Speed Class 1 |
| Video Speed Class    | V30               |

- Ideal for Android smartphones and tablets
- Extreme fast transfer speeds up to 100 MB/s read and 60 MB/s write
- UHS Speed Class 3 (U3) and Video Speed Class 30 (V30) to support demanding AAA/3D/VR game graphics and 4K UHD video
- A1 rating for faster loading of apps and improved performance
- Waterproof, temperature-proof, X-ray proof, and shockproof
- RescuePRO Deluxe data recovery software download offer

## SanDisk

microSD Memory Card  
"Extreme, 2 Pieces",  
100 MB/s

|                      |                   |
|----------------------|-------------------|
| UHS Standard         | UHS-I             |
| Standard Speed Class | UHS Speed Class 1 |
| Video Speed Class    | V30               |

- Ideal for Android smartphones and tablets
- Extreme fast transfer speeds up to 100 MB/s read and 60 MB/s write
- UHS Speed Class 3 (U3) and Video Speed Class 30 (V30) to support demanding AAA/3D/VR game graphics and 4K UHD video
- A1 rating for faster loading of apps and improved performance
- Waterproof, temperature-proof, X-ray proof, and shockproof
- RescuePRO Deluxe data recovery software download offer

|        |          |
|--------|----------|
| 128 GB | 00186538 |
| 100 BK |          |

|       |          |
|-------|----------|
| 64 GB | 00183551 |
| 50 BK |          |

|       |          |
|-------|----------|
| 32 GB | 00186490 |
| 50 BK |          |

|       |          |
|-------|----------|
| 32 GB | 00173444 |
| 50 BK |          |

STORAGE MEDIA & ACCESSORIES



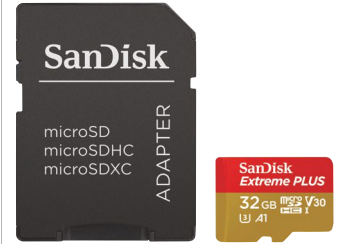

## SanDisk

### microSDXC Extreme "Nintendo licensed Zelda Edition", 1 TB

- Designed, tested and approved for memory expansion of Nintendo Switch game system
- Consistent high performance so you can load games fast with read speed up to 100MB/s
- Download games faster with write speed up to 90MB/s
- Incredible speeds in a microSD card officially licensed for the Nintendo Switch system
- Add more memory for more games, screenshots and video captures
- No longer carry multiple game cards, download games directly to a single memory card and play anytime, anywhere

|       |          |
|-------|----------|
| 1 TB  | 00220030 |
| 10 BK |          |

## SanDisk

### microSDXC Extreme "Nintendo-licensed Yoshi Edition", 64 GB

|              |       |
|--------------|-------|
| UHS Standard | UHS-I |
|--------------|-------|

- Designed, tested and approved for memory expansion of Nintendo Switch game system
- Consistent high performance so you can load games fast with read speed up to 100MB/s
- Download games faster with write speed up to 90MB/s
- Incredible speeds in a microSD card officially licensed for the Nintendo Switch system
- Add more memory for more games, screenshots and video captures
- No longer carry multiple game cards, download games directly to a single memory card and play anytime, anywhere

|       |          |
|-------|----------|
| 64 GB | 00220029 |
| 25 BK |          |

## SanDisk

### microSDXC Elite Ultra 64GB, 100MB/s, + adapter & Rescue Pro & Magisto

|        |          |
|--------|----------|
| 64 GB  | 00183546 |
| 100 BK |          |

## SanDisk

### microSD Memory Card "Extreme Plus + Adapter/ Mobile", 95 MB/s

|                      |                             |
|----------------------|-----------------------------|
| UHS Standard         | UHS-I                       |
| Standard Speed Class | Class 10, UHS Speed Class 3 |
| Video Speed Class    | V30                         |

- Especially recommendable for high-quality mobile phones, smartphones and tablet PCs
- Ideal for memory consuming applications like high-resolution full HD or 4k video shots, app use and multi tasking
- Enables extremely fast data transfer with up to 95MB/sec. read and up to 90MB/sec. write speed
- Suitable for terminal devices with a microSDHC slot (not compatible with standard microSD cards)
- With an adapter (included) also suitable for terminal devices with an SDHC slot (not for standard SD cards)
- Extended, tested temperature range from -25°C up to +85°C
- Genuine SanDisk branded item, OEM quality

|       |          |
|-------|----------|
| 32 GB | 00173424 |
| 50    |          |



# Cardreader

Card Reader



**hama**

Card Reader  
"SD/microSD, Aluminium"

|                    |                |
|--------------------|----------------|
| Connection         | USB-Typ-A-Plug |
| Data Transfer Rate | Up to 5 Gbit/s |
| USB Standard       | USB 3.0        |

- Allows fast data transfer between the card and the PC when used with a UHS-I capable SD/microSD card
- Allows direct data exchange between memory cards
- High-quality and robust metal casing
- LED function indicator gives information about the connection status
- Supports USB 3.0 SuperSpeed 5 Gbps
- Downward compatible with USB 2.0 (480 Mbit/s) and USB 1.1 (12 Mbit/s)

Memory cards:  
 • SD/SDHC/SDXC  
 • microSD/microSDHC/microSDXC  
 • Operating system: Windows 11/10/8/7/Vista/XP or Mac OS 9.x or higher

|       |    |    |  |                 |
|-------|----|----|--|-----------------|
| Black |    |    |  | <b>00123900</b> |
|       | 30 | BK |  |                 |



**hama**

Card Reader  
"SD/microSD/CF"

|                    |                |
|--------------------|----------------|
| Connection         | USB-Typ-A-Plug |
| Data Transfer Rate | Up to 5 Gbit/s |
| USB Standard       | USB 3.0        |

- Allows fast data transfer between the card and the PC when used with a UDMA capable CF card
- Allows fast data transfer between the card and the PC when used with a UHS-I capable SD/microSD card
- USB cable for connection to a PC / laptop
- Supports USB 3.0 SuperSpeed 5 Gbps
- Backwards-compatible with USB 2.0 (480 Mbit/s) and USB 1.1 (12 Mbit/s)

Memory Cards:  
 • SD/SDHC/SDXC  
 • MicroSD/microSDHC/microSDXC  
 • CompactFlash I  
 • Operating system: Windows 11/10/8/7/Vista/XP and Mac OS 9.x or later

|       |    |    |  |                 |
|-------|----|----|--|-----------------|
| Black |    |    |  | <b>00124022</b> |
|       | 25 | SC |  |                 |



**hama**

Card Reader  
"SD/microSD/CF/MS"

|                    |                |
|--------------------|----------------|
| Connection         | USB-Typ-A-Plug |
| Data Transfer Rate | Up to 5 Gbit/s |
| USB Standard       | USB 3.0        |

- Allows fast data transfer between the card and the PC when used with a UHS-I capable SD/microSD card
- Allows fast data transfer between the card and the PC when used with a UDMA capable CF card
- Allows direct data exchange between memory cards
- Super speed data transfer rates of up to 5 Gbps
- LED function indicator gives information about the connection status
- Backwards-compatible with USB 2.0 (480 Mbit/s)
- Supports UDMA 7 mode
- Unique PID and VID

Memory Cards:  
 • SD/SDHC/SDXC  
 • MicroSD/microSDHC/microSDXC  
 • CompactFlash I  
 • MS/MS Duo/MS PRO Duo/MS PRO Duo HG  
 • Operating system: Windows 11/10/8/7/Vista/XP or Mac OS 9.x or later

|       |    |    |  |                 |
|-------|----|----|--|-----------------|
| White |    |    |  | <b>00181017</b> |
| Black |    |    |  | <b>00181018</b> |
|       | 25 | BK |  |                 |



**hama**

Card Reader  
"UHS-II SD/SDHC/SDXC"

|                    |                |
|--------------------|----------------|
| Connection         | USB-Typ-A-Plug |
| Data Transfer Rate | Up to 5 Gbit/s |
| USB Standard       | USB 3.0        |

- Extremely fast data transfer rate (up to 312 MB/s) between the card and the PC when used with an appropriate UHS-II SD card
- High-quality and robust metal casing
- LED function indicator gives information about the connection status
- Backwards-compatible with USB 2.0 (480 Mbit/s), USB 1.1 (12 Mbit/s), UHS-I and non-UHS-enabled SD cards
- Supports USB 3.0 SuperSpeed 5 Gbps

Memory Cards:  
 • SD/SDHC/SDXC  
 • microSD/microSDHC/microSDXC (with adapter, not included in the extent of delivery)  
 • Operating system: Win 11/10/8/7/Vista/XP and MAC OS 9.x or later

|            |    |    |  |                 |
|------------|----|----|--|-----------------|
| Anthracite |    |    |  | <b>00124024</b> |
|            | 10 | BK |  |                 |



STORAGE MEDIA & ACCESSORIES

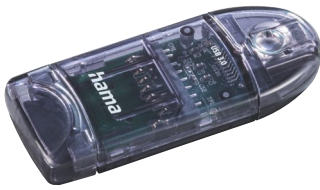

**hama**

**USB 3.0 Card Reader, SD/  
micro SD, anthracite**

|                    |                |
|--------------------|----------------|
| Connection         | USB-Typ-A-Plug |
| Data Transfer Rate | Up to 5 Gbit/s |
| USB Standard       | USB 3.0        |

- LED function indicator provides information about the connection status
- Supports USB 3.0 (5 Gbit/s), USB 2.0 (480 Mbit/s) and USB 1.1 (12 Mbit/s)
- 2-slot solution with direct USB connection (no USB cable required)
- Ideal for mobile use

Memory Cards:

- SD/SDHC/SDXC
- MicroSD/microSDHC/microSDXC
- Operating system: Windows 10/8/7/XP and MAC OS 9.x or later

|            |    |    |  |                 |
|------------|----|----|--|-----------------|
| Anthracite |    |    |  | <b>00124194</b> |
|            | 25 | SC |  |                 |



**hama**

**Card Reader  
"35in1 SD/CF/MS/xD/SM"**

|                    |                  |
|--------------------|------------------|
| Connection         | USB-Typ-A-Plug   |
| Data Transfer Rate | Up to 480 Mbit/s |
| USB Standard       | USB 2.0          |

- Allows fast data transfer between the card and the PC when used with a UDMA capable CF card
- Allows direct data exchange between memory cards
- LED function indicator gives information about the connection status
- USB cable for connection with PC/laptop
- Supports USB 2.0 (480 Mbit/s) and USB 1.1

Memory cards:

- SD/SDHC/SDXC
- microSD/microSDHC/microSDXC (with adapter, not included in the delivery package)
- CompactFlash I & II
- MS/MS Duo/MS PRO Duo/MS PRO Duo HG
- Smart Media Card
- xD-Picture Card
- Operating system: Windows 11/10/8/7/Vista/XP and Mac OS 9.x or higher

|      |    |    |  |                 |
|------|----|----|--|-----------------|
| Blue |    |    |  | <b>00055348</b> |
|      | 25 | SC |  |                 |



**hama**

**Card Reader  
"8in1 SD/microSD"**

|                    |                  |
|--------------------|------------------|
| Connection         | USB-Typ-A-Plug   |
| Data Transfer Rate | Up to 480 Mbit/s |
| USB Standard       | USB 2.0          |

- Allows direct data exchange between memory cards
- LED function indicator gives information about the connection status
- Supports USB 2.0 (480 Mbit/s) and USB 1.1 (12 Mbit/s)
- 2 slot solution with direct USB connection (no USB cable necessary)
- Ideal for travelling

Memory cards:

- SD/SDHC/SDXC
- microSD/microSDHC/microSDXC
- Operating system: Windows 11/10/8/7/Vista/XP bzw. Mac OS 9.x or higher

|             |    |    |  |                 |
|-------------|----|----|--|-----------------|
| Transparent |    |    |  | <b>00091092</b> |
|             | 50 | BK |  |                 |

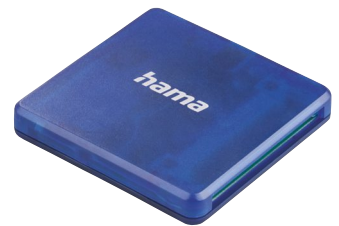

**hama**

**USB 2.0 Multi Card Reader,  
SD/microSD/CF, blue**

|                    |                  |
|--------------------|------------------|
| Connection         | USB-Typ-A-Plug   |
| Data Transfer Rate | Up to 480 Mbit/s |
| USB Standard       | USB 2.0          |

- Allows fast data transfer between the card and the PC when used with a UDMA capable CF card
- LED function indicator gives information about the connection status
- USB cable for connection with PC/laptop
- Supports USB 2.0 (480 Mbit/s)

Memory cards:

- SD/SDHC/SDXC
- microSD/microSDHC/microSDXC
- CompactFlash I
- Operating system: Windows 11/10/8/7/Vista/XP and Mac OS 9.x or higher

|      |    |    |  |                 |
|------|----|----|--|-----------------|
| Blue |    |    |  | <b>00124131</b> |
|      | 25 | PO |  |                 |



STORAGE MEDIA & ACCESSORIES

# Cardreader



**SanDisk**

**Card Reader**  
**"USB-3.0 MobileMate, for microSD-Memory Card"**

|                    |                |
|--------------------|----------------|
| Connection         | USB-Typ-A-Plug |
| Data Transfer Rate | Up to 500 MB/s |
| USB Standard       | USB 3.0        |

- allows fast data transfer between the card and the PC when used with a UHS-I capable microSD card
- practically disappears in the USB port
- especially suited for Notebook users
- downward compatible with USB 2.0

|       |    |    |  |                 |
|-------|----|----|--|-----------------|
| Black |    |    |  | <b>00139770</b> |
|       | 25 | BK |  |                 |



**SanDisk**

**"ImageMate PRO" USB-C 3.0**  
**Card Reader**

|              |            |
|--------------|------------|
| Connection   | USB-C-plug |
| USB Standard | USB 3.0    |

- High performance speeds of up to 312 MB/s for SD and microSD, and up to 160MB/s for CompactFlash cards
- Especially recommendable for UHS-II SD and microSD capable memory cards
- Supports CompactFlash cards up to UDMA 7
- Backward-compatible with USB 2.0 and UHS-I
- Works with Windows and Mac Computers
- Operating system: Windows 8 or higher, MacOS 10.5 or higher

|  |    |    |  |                 |
|--|----|----|--|-----------------|
|  |    |    |  | <b>00186482</b> |
|  | 20 | BK |  |                 |



**SanDisk**

**"Extreme Pro" USB-C 3.0**  
**Card Reader for SD UHS-II**

|              |            |
|--------------|------------|
| Connection   | USB-C-plug |
| USB Standard | USB 3.0    |

- Designed for high-speed SD UHS-II card transfers
- Compatible with UHS-II, backwards-compatible with UHS-I and non-UHS SD cards
- Plug and Play - plug it in, and it works
- Backward-compatible with USB 2.0
- Convenient, reversible USB-C connector

|       |    |    |  |                 |
|-------|----|----|--|-----------------|
| Black |    |    |  | <b>00173498</b> |
|       | 25 | BK |  |                 |



**SanDisk**

**USB 3.0 Card Reader for SD**  
**UHS-I memory cards**

|              |                |
|--------------|----------------|
| Connection   | USB-Typ-A-Plug |
| USB Standard | USB 3.0        |

- allows fast data transfer between the card and the PC when used with a UHS-I capable SD card
- fast UHS-I transfer speeds of up to 170 MB/s
- compact and durable for portability
- downward compatible with USB 2.0

|       |    |    |  |                 |
|-------|----|----|--|-----------------|
| Black |    |    |  | <b>00173359</b> |
|       | 20 | BK |  |                 |



STORAGE MEDIA & ACCESSORIES



**SanDisk**

**CF Express Extreme Pro Card Reader**

|            |                             |
|------------|-----------------------------|
| Connection | USB-C-Connector, USB-C-plug |
|------------|-----------------------------|

**Memory Card Box**



**hama**

**Memory Card Box, black/transparent**

|                        |                  |
|------------------------|------------------|
| Material               | Plastic Material |
| Max. Capacity (Pieces) | 10               |

- Holds up to 10 memory cards
- Flexible, breakproof box which protects the cards from becoming damaged
- Date and memo area (can be labelled)
- Extremely flat and space-saving
- Fits in a 10x15 slip-in photo album

|       |          |
|-------|----------|
| Black | 00095985 |
|       | 180 BK   |



**hama**

**"SD Slim Box" Memory Card Box, transparent**

|                        |                  |
|------------------------|------------------|
| Material               | Plastic Material |
| Max. Capacity (Pieces) | 1                |
| Suitable for           | SD & MMC         |

- Prevents your memory card from becoming damaged
- Flexible, breakproof box
- Extremely flat and space-saving

|             |          |
|-------------|----------|
| Transparent | 00095949 |
|             | 6 BK     |



**hama**

**"SD Slim Box" Memory Card Box, for 1 Card, transparent**

|                        |                    |
|------------------------|--------------------|
| Material               | Polypropylene (PP) |
| Max. Capacity (Pieces) | 1                  |
| Suitable for           | SD & MMC           |

- Protects the memory card from damage
- Flexible, shatterproof protective box, ideal for transport in a laptop bag, etc.
- Extremely flat and space-saving

|             |          |
|-------------|----------|
| Transparent | 00095989 |
|             | 8 HB     |



**hama**

**"DuoCase" Memory Card Box, transparent**

|                        |                  |
|------------------------|------------------|
| Material               | Plastic Material |
| Max. Capacity (Pieces) | 2                |
| Suitable for           | SD & MMC         |

- Prevents your memory card from becoming damaged
- Flexible, breakproof box
- Extremely flat and space-saving

|             |          |
|-------------|----------|
| Transparent | 00095947 |
|             | 6 BK     |



**hama**

**"DuoCase" Memory Card Box, for 2 Cards, transparent**

|                        |                    |
|------------------------|--------------------|
| Material               | Polypropylene (PP) |
| Max. Capacity (Pieces) | 2                  |
| Suitable for           | SD & MMC           |

- Protects the memory card from damage
- Flexible, shatterproof protective box, ideal for transport in a laptop bag, etc.
- Extremely flat and space-saving

|             |          |
|-------------|----------|
| Transparent | 00095988 |
|             | 8 HB     |

|       |          |
|-------|----------|
| Black | 00186494 |
|       | 20 BK    |

STORAGE MEDIA & ACCESSORIES

# Storage Media

## Internal SSD Hard Drive



### SanDisk

#### Internal SSD Hard Drive "Plus, 350MB/s write"

|                         |          |
|-------------------------|----------|
| Connection              | SATA 3   |
| Transfer Rate (Reading) | 535 MB/s |
| Transfer Rate (Writing) | 350 MB/s |
| Design                  | 2.5 "    |

- Fast loading and running of programs
- Read speeds up to 535 MB/s and write speeds up to 350 MB/s
- SATA 3 (6 Gbit/s)
- SLC caching boosts burst write performance
- User-friendly SSD Dashboard to clone, monitor and manage the drive

### SanDisk

#### Internal SSD Hard Drive "Plus, SATA 3 (6Gbit/s)"

|                         |          |
|-------------------------|----------|
| Connection              | SATA 3   |
| Transfer Rate (Reading) | 535 MB/s |
| Transfer Rate (Writing) | 450 MB/s |
| Design                  | 2.5 "    |

### SanDisk

#### Internal SSD Hard Drive "Ultra 3D"

|                         |          |
|-------------------------|----------|
| Connection              | SATA 3   |
| Transfer Rate (Reading) | 550 MB/s |
| Transfer Rate (Writing) | 550 MB/s |
| Design                  | 2.5 "    |

### SanDisk

#### Internal SSD Hard Drive "Ultra 3D, New"

|                         |          |
|-------------------------|----------|
| Connection              | SATA 3   |
| Transfer Rate (Reading) | 560 MB/s |
| Transfer Rate (Writing) | 510 MB/s |
| Design                  | 2.5 "    |

- Fast loading and running of programs
- Read speeds up to 555 MB/s and write speeds up to 440 MB/s
- SATA 3 (6 Gbit/s)
- nCache-2.0-Technologie for blazing fast speeds
- Latest 3D NAND technology for maximum performance and durability
- User-friendly SSD Dashboard to clone, monitor and manage the drive
- RescuePRO Deluxe data recovery software download offer

|       |          |
|-------|----------|
| 1 TB  | 00121530 |
| 10 HB |          |

|        |          |
|--------|----------|
| 2 TB   | 00186461 |
| 10 BK  |          |
| 480 GB | 00173342 |
| 10 BK  |          |
| 240 GB | 00173341 |
| 10 BK  |          |

|        |          |
|--------|----------|
| 4 TB   | 00123934 |
| 10 HB  |          |
| 2 TB   | 00173454 |
| 10 HB  |          |
| 500 GB | 00173452 |
| 10 HB  |          |
| 250 GB | 00173451 |
| 10 HB  |          |

|        |          |
|--------|----------|
| 2 TB   | 00215431 |
| 10 HB  |          |
| 250 GB | 00215430 |
| 10 HB  |          |



STORAGE MEDIA & ACCESSORIES

**SanDisk**

**Internal SSD Hard Drive  
"Ultra 3D SATA 2.5"**

|                         |          |
|-------------------------|----------|
| Connection              | SATA 3   |
| Transfer Rate (Reading) | 555 MB/s |
| Transfer Rate (Writing) | 520 MB/s |
| Design                  | 2.5 "    |

|      |  |  |    |    |  |  |  |  |  |                 |
|------|--|--|----|----|--|--|--|--|--|-----------------|
| 4 TB |  |  |    |    |  |  |  |  |  | <b>00215497</b> |
|      |  |  | 10 | HB |  |  |  |  |  |                 |
| 2 TB |  |  |    |    |  |  |  |  |  | <b>00215496</b> |
|      |  |  | 10 | HB |  |  |  |  |  |                 |
| 1 TB |  |  |    |    |  |  |  |  |  | <b>00220031</b> |
|      |  |  | 10 | HB |  |  |  |  |  |                 |



**SanDisk**

**Internal SSD Hard Drive  
"Ultra M.2 NVMe"**

|                         |                 |
|-------------------------|-----------------|
| Connection              | M.2             |
| Transfer Rate (Reading) | 3500 MB/s       |
| Transfer Rate (Writing) | 2300 MB/s       |
| Design                  | M.2 2280 NVMe " |

- Extreme fast and reliable M.2-SSD with PCIe Gen3 (8Gbit/s)
- For fast loading and running of programs and applications (up to 5x faster than SATA SSDs)
- Read speeds up to 3.500 MB/s and write speeds up to 2.300 MB/s
- Durability: up to 300 TBW (Terrabytes Written)
- Latest 3D NAND technology for maximum performance and durability
- User-friendly SSD Dashboard to clone, monitor and manage the drive

|        |  |  |    |    |  |  |  |  |  |                 |
|--------|--|--|----|----|--|--|--|--|--|-----------------|
| 2 TB   |  |  |    |    |  |  |  |  |  | <b>00215434</b> |
|        |  |  | 10 | HB |  |  |  |  |  |                 |
| 1 TB   |  |  |    |    |  |  |  |  |  | <b>00215433</b> |
|        |  |  | 10 | HB |  |  |  |  |  |                 |
| 500 GB |  |  |    |    |  |  |  |  |  | <b>00215432</b> |
|        |  |  | 10 | HB |  |  |  |  |  |                 |

**SanDisk**

**SSD Ultra 3D 2TB, incl. Rescue Pro**

|      |  |  |    |    |  |  |  |  |  |                 |
|------|--|--|----|----|--|--|--|--|--|-----------------|
| 2 TB |  |  |    |    |  |  |  |  |  | <b>00220046</b> |
|      |  |  | 10 | HB |  |  |  |  |  |                 |



**SanDisk**

**SSD Ultra 3D 500GB**

|                         |          |
|-------------------------|----------|
| Connection              | SATA 3   |
| Transfer Rate (Reading) | 560 MB/s |
| Transfer Rate (Writing) | 530 MB/s |
| Design                  | 2.5 "    |

|        |  |  |    |    |  |  |  |  |  |                 |
|--------|--|--|----|----|--|--|--|--|--|-----------------|
| 500 GB |  |  |    |    |  |  |  |  |  | <b>00215477</b> |
|        |  |  | 10 | HB |  |  |  |  |  |                 |



STORAGE MEDIA & ACCESSORIES

# Storage Media

## External SSD Hard Drive

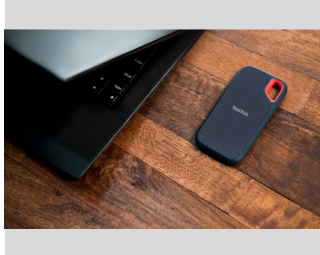

**SanDisk**

### External SSD Hard Drive "Extreme Portable, USB 3.2 Gen 2", Black, Orange

|                         |           |
|-------------------------|-----------|
| Transfer Rate (Reading) | 1050 MB/s |
| Transfer Rate (Writing) | 1000 MB/s |

- USB 3.1 Gen 2 interface for extreme fast transfer speeds
- Read- and write speeds of up to 1050 MB/s
- Lightweight and pocket-sized for more portability
- IP55 rating for dust and water resistance
- Forged aluminum structure with durable silicone coating
- Works with Windows and Mac Computers and USB-C and USB-A inputs
- Password protection and 256-bit AES file encryption software

|        |  |   |    |                 |
|--------|--|---|----|-----------------|
| 4 TB   |  |   |    | <b>00186582</b> |
|        |  | 5 | HB |                 |
| 2 TB   |  |   |    | <b>00186534</b> |
|        |  | 5 | HB |                 |
| 1 TB   |  |   |    | <b>00186533</b> |
|        |  | 5 | HB |                 |
| 500 GB |  |   |    | <b>00186532</b> |
|        |  | 5 | HB |                 |



**SanDisk**

### External SSD Hard Drive "Extreme Pro Portable, USB 3.2 Gen 2x2", Black, Orange

|                         |           |
|-------------------------|-----------|
| Transfer Rate (Reading) | 2000 MB/s |
| Transfer Rate (Writing) | 2000 MB/s |

- USB 3.2 Gen 2x2 interface for extreme fast transfer speeds
- Read- and write speeds of up to 2000 MB/s
- Lightweight and pocket-sized for more portability
- IP55 rating for dust and water resistance
- Forged aluminum structure with durable silicone coating
- Works with Windows and Mac Computers and USB-C and USB-A inputs
- Password protection and 256-bit AES file encryption software

|      |  |   |    |                 |
|------|--|---|----|-----------------|
| 4 TB |  |   |    | <b>00186583</b> |
|      |  | 5 | HB |                 |
| 2 TB |  |   |    | <b>00186535</b> |
|      |  | 5 | HB |                 |
| 1 TB |  |   |    | <b>00186530</b> |
|      |  | 5 | HB |                 |



**SanDisk**

### External SSD Hard Drive "Portable, USB 3.2 Gen 2", Black

|                         |          |
|-------------------------|----------|
| Transfer Rate (Reading) | 520 MB/s |
|-------------------------|----------|

- USB 3.2 Gen 2 interface for fast transfer speeds
- Read- and write speeds of up to 520 MB/s
- Durable drive, two-meter drop protection
- Tough rubber hook to secure it to a belt loop or backpack

|        |  |   |    |                 |
|--------|--|---|----|-----------------|
| 2 TB   |  |   |    | <b>00186578</b> |
|        |  | 5 | HB |                 |
| 1 TB   |  |   |    | <b>00186577</b> |
|        |  | 5 | HB |                 |
| 480 GB |  |   |    | <b>00186576</b> |
|        |  | 5 | HB |                 |

**SanDisk**

### External SSD "Desk Drive", 8TB, USB-C, 1000MB/s

|  |  |   |    |                 |
|--|--|---|----|-----------------|
|  |  |   |    | <b>00220081</b> |
|  |  | 5 | HB |                 |



STORAGE MEDIA & ACCESSORIES



**SanDisk**

External SSD  
"Desk Drive", 4TB, USB-C,  
1000MB/s

|          |    |  |
|----------|----|--|
| 00220080 |    |  |
| 5        | HB |  |

USB Memory Stick



**SanDisk**

USB Memory Stick  
"Blade", Black, Red

| Material | Plastic Material |
|----------|------------------|
|----------|------------------|

- USB 2.0 flash drive in a lightweight design
- Compact, elegant, lightweight design with practical eyelet for attachment to a keychain
- Plug-and-stay storage for notebooks, tablets, TVs, gaming consoles, car audio systems, and more
- Password protection and 128-bit AES file encryption software
- Secure file encryption and password protection with included SanDisk SecureAccess software
- Operating system: Windows 7/Vista/XP/2000/ME, Linux, MacOS X ver. 10.1.2 or higher

|        |          |    |
|--------|----------|----|
| 128 GB | 00124043 |    |
|        | 50       | BK |
| 64 GB  | 00114925 |    |
|        | 50       | BK |
| 32 GB  | 00114712 |    |
|        | 50       | BK |
| 16 GB  | 00104336 |    |
|        | 50       | BK |

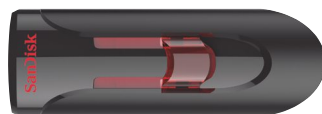

**SanDisk**

USB Memory Stick  
"Cruzer Glide", Black

| Material | Plastic Material |
|----------|------------------|
|----------|------------------|

|        |          |    |
|--------|----------|----|
| 128 GB | 00173405 |    |
|        | 50       | BK |

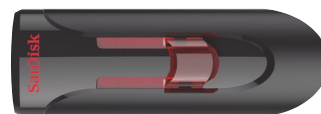

**SanDisk**

USB Memory Stick  
"Cruzer Glide"

| Material | Plastic Material |
|----------|------------------|
|----------|------------------|

- USB 3.0 technology for fast data transfer
- Sturdy plastic housing with a retractable USB connector
- Downward compatible with USB 2.0
- Includes SanDisk SecureAccess software (download necessary): protects your private files in an encrypted, password protected folder (128-bit AES encryption)
- Operating system: Windows 10/8/7/ Vista, Linux, MacOS X version 10.1.2 or higher

|       |          |    |
|-------|----------|----|
| 32 GB | 00173403 |    |
|       | 50       | BK |



STORAGE MEDIA & ACCESSORIES

# Storage Media



## SanDisk

### USB Memory Stick "Cruzer Ultra Extreme Go, USB 3.2", Black, Silver

| Material | Brushed Aluminium,<br>Plastic Material |
|----------|--|
|----------|--|

- Accelerate the workflow as you transfer, store and share critical content with superfast USB-A 3.2 interface
- Lightning fast read speeds of up to 400 MB/s
- sleek premium metal design
- Backward-compatible with USB 3.0 and 2.0 ports
- Protect files with individual password
- RescuePRO Deluxe data recovery software download offer

|        |    |    |  |                 |
|--------|----|----|--|-----------------|
| 128 GB |    |    |  | <b>00186564</b> |
|        | 25 | BK |  |                 |
| 64 GB  |    |    |  | <b>00186563</b> |
|        | 25 | BK |  |                 |



## SanDisk

### USB Memory Stick "Glide", Black

| Material | Plastic Material |
|----------|------------------|
|----------|------------------|

- USB 2.0 flash drive with a lightweight design and retractable USB port
- Plug-and-stay storage for notebooks, tablets, TVs, gaming consoles, car audio systems, and more
- Password protection and 128-bit AES file encryption software SanDisk SecureAccess
- RescuePRO Deluxe data recovery software download offer
- Operating system: Windows Vista/7/8/10, Mac OS X Ver. 10.7 or higher

|        |    |    |  |                 |
|--------|----|----|--|-----------------|
| 256 GB |    |    |  | <b>00139795</b> |
|        | 50 | BK |  |                 |
| 128 GB |    |    |  | <b>00114914</b> |
|        | 50 | BK |  |                 |
| 64 GB  |    |    |  | <b>00114879</b> |
|        | 50 | BK |  |                 |
| 32 GB  |    |    |  | <b>00114878</b> |
|        | 50 | BK |  |                 |



## SanDisk

### USB Memory Stick "iXpand Flash Drive Go", Black, Silver

| Material | Brushed Aluminium,<br>Plastic Material |
|----------|--|
|----------|--|

- Highspeed Flash-Drive with lightning and USB 3.0 connection
- Free up space on your iPhone/iPad
- Shoot videos and pictures directly onto the iXpand flash drive
- Automatically back up new photos and videos with the iXpand Drive App (free download available)
- Quickly move content to your computer thanks to the USB 3.0 connectors
- Backward-compatible with USB 2.0 ports
- Protect files with individual password
- Rotatable design with key ring for attachment to a keychain and protection of the connectors

|        |    |    |  |                 |
|--------|----|----|--|-----------------|
| 256 GB |    |    |  | <b>00183589</b> |
|        | 25 | BK |  |                 |
| 128 GB |    |    |  | <b>00183588</b> |
|        | 25 | BK |  |                 |
| 64 GB  |    |    |  | <b>00186489</b> |
|        | 25 | BK |  |                 |



## SanDisk

### USB Memory Stick "iXpand Luxe, USB 3.1, UBS-C", Black

| Material | Plastic Material |
|----------|------------------|
|----------|------------------|

- Highspeed Flash-Drive with USB-C and Lightning 3.1 Gen 1 connection
- Free up space on your iPhone, iPad Pro, Mac, and USB Type-C devices, including Android phones
- Automatically back up new photos and videos with the SanDisk Memory zone App (free download available)
- Quickly move content to your computer thanks to the USB 3.1 Gen 1 connector
- Protect files with individual password across iOS devices and PC computers
- Backward-compatible with USB 2.0 ports
- Rotatable, stylish design with key ring for attachment to a keychain and protection of the connectors

|        |    |    |  |                 |
|--------|----|----|--|-----------------|
| 256 GB |    |    |  | <b>00186554</b> |
|        | 25 | BK |  |                 |
| 128 GB |    |    |  | <b>00186553</b> |
|        | 25 | BK |  |                 |
| 64 GB  |    |    |  | <b>00186552</b> |
|        | 25 | BK |  |                 |



STORAGE MEDIA & ACCESSORIES



## SanDisk

**USB Memory Stick**  
"Snap, USB 2.0", Black, Red

| Material | Plastic Material |
|----------|------------------|
|----------|------------------|

- USB 2.0 flash drive with reliable housing protection
- retractable design protects the connector from dirt and damage
- space for your photos, music, documents and other files
- practical eyelet for attachment to the keyring
- password protection and 128-bit AES file encryption software

|       |  |    |    |                 |
|-------|--|----|----|-----------------|
| 64 GB |  |    |    | <b>00183585</b> |
|       |  | 50 | BK |                 |
| 32 GB |  |    |    | <b>00183584</b> |
|       |  | 50 | BK |                 |



## SanDisk

**USB Memory Stick**  
"Spark", Black

| Material | Plastic Material |
|----------|------------------|
|----------|------------------|

- USB 2.0 flash drive with reliable housing protection
- All data always ready to hand with practical eyelet for attachment to a keychain
- Works with PC and Mac
- Password protection and 128-bit AES file encryption software

|       |  |    |    |                 |
|-------|--|----|----|-----------------|
| 64 GB |  |    |    | <b>00183538</b> |
|       |  | 50 | BK |                 |



## SanDisk

**USB Memory Stick**  
"Ultra Dual Drive Go, USB-C", Absinthe Green

|        |  |    |    |                 |
|--------|--|----|----|-----------------|
| 256 GB |  |    |    | <b>00220073</b> |
|        |  | 25 | BK |                 |
| 128 GB |  |    |    | <b>00220072</b> |
|        |  | 25 | BK |                 |
| 64 GB  |  |    |    | <b>00220071</b> |
|        |  | 50 | BK |                 |

## SanDisk

**USB Memory Stick**  
"Ultra Dual Drive Go, USB-C", Navagio Bay

|        |  |    |    |                 |
|--------|--|----|----|-----------------|
| 256 GB |  |    |    | <b>00220067</b> |
|        |  | 50 | BK |                 |
| 128 GB |  |    |    | <b>00220066</b> |
|        |  | 50 | BK |                 |
| 64 GB  |  |    |    | <b>00220065</b> |
|        |  | 50 | BK |                 |

# Storage Media

## SanDisk

USB Memory Stick  
"Ultra Dual Drive Go, USB-C",  
Lavender



## SanDisk

USB Memory Stick  
"Ultra Dual Drive m3.0",  
Black, Transparent

| Material | Metal, Plastic<br>Material |
|----------|----------------------------|
|----------|----------------------------|

- Ideal as external storage for mobile devices
- Transfer files between OTG-enabled Android smartphones and tablets and PC and Mac computers
- Sleek retractable design with both micro-USB and USB 3.0 connectors
- High-speed USB 3.0 performance of up to 130MB/s
- Backward-compatible with USB 2.0 ports
- SanDisk Memory Zone file management app for easy backup  
For PC or Mac computers: Windows 10, 8, 7 or Mac OS X version 10.6 or higher  
For mobile phone or tablet PC: host/OTG compatible mobile phones and tablet PCs with Android

|        |  |    |    |                 |
|--------|--|----|----|-----------------|
| 16 GB  |  |    |    | <b>00173383</b> |
|        |  | 50 | BK |                 |
| 256 GB |  |    |    | <b>00173430</b> |
|        |  | 25 | BK |                 |
| 128 GB |  |    |    | <b>00173386</b> |
|        |  | 25 | BK |                 |
| 64 GB  |  |    |    | <b>00173385</b> |
|        |  | 50 | BK |                 |
| 32 GB  |  |    |    | <b>00173384</b> |
|        |  | 50 | BK |                 |



## SanDisk

USB Memory Stick  
"Ultra Dual Drive, Type-C",  
Black, Silver

| Material | Metal, Plastic<br>Material |
|----------|----------------------------|
|----------|----------------------------|

- Ideal as external storage for mobile devices with USB Type-C™-Connector
- High-Speed USB 3.1 Flash-Drive for USB Type-C™-Devices
- Retractable dual connector flash drive for USB Type-C™ and USB Type-A ports
- High-speed USB 3.1 performance of up to 150MB/s
- Reversible design, plugs in either way
- SanDisk Memory Zone file management app for easy backup

|        |  |    |    |                 |
|--------|--|----|----|-----------------|
| 256 GB |  |    |    | <b>00139778</b> |
|        |  | 25 | BK |                 |
| 128 GB |  |    |    | <b>00173339</b> |
|        |  | 25 | BK |                 |
| 64 GB  |  |    |    | <b>00173338</b> |
|        |  | 50 | BK |                 |
| 32 GB  |  |    |    | <b>00173337</b> |
|        |  | 50 | BK |                 |



## SanDisk

USB Memory Stick  
"Ultra Flair", Black, Silver

| Material | Metal |
|----------|-------|
|----------|-------|

- Highspeed USB 3.0 Flash-Drive
- High-speed USB 3.0 performance of up to 130MB/s
- Sleek, durable metal casing
- Backward-compatible with USB 2.0 ports
- Password protection and 128-bit AES file encryption software
- RescuePRO Deluxe data recovery software download offer

|        |  |    |    |                 |
|--------|--|----|----|-----------------|
| 128 GB |  |    |    | <b>00139790</b> |
|        |  | 50 | BK |                 |
| 64 GB  |  |    |    | <b>00139789</b> |
|        |  | 50 | BK |                 |
| 32 GB  |  |    |    | <b>00139788</b> |
|        |  | 50 | BK |                 |
| 16 GB  |  |    |    | <b>00139787</b> |
|        |  | 50 | BK |                 |
| 512 GB |  |    |    | <b>00186477</b> |
|        |  | 50 | BK |                 |
| 256 GB |  |    |    | <b>00139774</b> |
|        |  | 50 | BK |                 |

|        |  |    |    |                 |
|--------|--|----|----|-----------------|
| 256 GB |  |    |    | <b>00220070</b> |
|        |  | 50 | BK |                 |
| 128 GB |  |    |    | <b>00220069</b> |
|        |  | 50 | BK |                 |
| 64 GB  |  |    |    | <b>00220068</b> |
|        |  | 50 | BK |                 |



STORAGE MEDIA & ACCESSORIES



## SanDisk

### USB Memory Stick "Ultra", Black

|                         |                  |
|-------------------------|------------------|
| Transfer Rate (Reading) | 100 MB/s         |
| Material                | Plastic Material |

- Highspeed USB 3.0 Flash-Drive
- Ultra fast transfer speeds up to 100MB/s
- Backward-compatible with USB 2.0 ports
- Password protection and 128-bit AES file encryption software
- RescuePRO Deluxe data recovery software download offer

|        |          |
|--------|----------|
| 256 GB | 00139717 |
| 50 BK  |          |
| 128 GB | 00124109 |
| 50 BK  |          |
| 64 GB  | 00123836 |
| 50 BK  |          |
| 32 GB  | 00123835 |
| 50 BK  |          |
| 16 GB  | 00123834 |
| 50 BK  |          |
| 512 GB | 00186476 |
| 50 BK  |          |

## SanDisk

### Ultra Dual USB Flash Drive Go 1TB, USB-C

|       |          |
|-------|----------|
| 1 TB  | 00220079 |
| 50 BK |          |



## SanDisk

### Cruzer Ultra, 64 GB, USB 3.0, 130 MB/s, red

|          |                         |
|----------|-------------------------|
| Material | Metal, Plastic Material |
|----------|-------------------------|

- With USB 3.0 technology for capacity expansion
- Removable USB 3.0 storage medium (downward compatible with USB 2.0)
- Allows ultra fast data transfer with up to 100 MB/s
- Sturdy plastic casing with a retractable USB connector
- SanDisk SecureAccess software included (download necessary): protects your private files in an encrypted, password protected folder (128-bit AES encryption)
- Operating system: Windows 10/8/7/ Vista/XP, MacOS X version 10.1.2 or higher

|       |          |
|-------|----------|
| 64 GB | 00173325 |
| 50    |          |

## SanDisk

### Cruzer Ultra, 64GB, USB 3.0, 130 MB/s, black, 3 Pack

|       |          |
|-------|----------|
|       | 00220040 |
| 25 BK |          |

# Storage Media



## SanDisk

**Cruzer Blade 16GB, 3 Pieces, Blue, Pink, Green**

|          |                         |
|----------|-------------------------|
| Material | Metal, Plastic Material |
|----------|-------------------------|

- USB 2.0 flash drive in a lightweight design
- Compact, elegant, lightweight design with practical eyelet for attachment to a keychain
- Plug-and-stay storage for notebooks, tablets, TVs, gaming consoles, car audio systems, and more
- Password protection and 128-bit AES file encryption software
- Secure file encryption and password protection with included SanDisk SecureAccess software
- Operating system: Windows 7/Vista/XP/2000/ME, Linux, MacOS X ver. 10.1.2 or higher

|       |          |
|-------|----------|
| 16 GB | 00173438 |
| 50 BK |          |

## SanDisk

**Cruzer Ultra Fit 32GB, USB 3.2, 130 MB/s, 3 Pack**

|       |          |
|-------|----------|
|       | 00220041 |
| 50 BK |          |

## SanDisk

**Cruzer Glide 32GB, USB 2.0, black, 3 Pack**

|       |          |
|-------|----------|
|       | 00220043 |
| 50 BK |          |

## SanDisk

**Cruzer Snap 32GB, USB 2.0, red/blue/black, 3 Pack**

|       |          |
|-------|----------|
|       | 00220042 |
| 50 BK |          |



STORAGE MEDIA & ACCESSORIES



## SanDisk

### Cruzer Blade 16GB Electric Blue

|          |                  |
|----------|------------------|
| Material | Plastic Material |
|----------|------------------|

- Removable USB 2.0 storage medium (downward compatible with USB 1.1)
- Includes SanDisk SecureAccess software (download necessary): protects your private files in an encrypted, password protected folder (128-bit AES encryption)
- Operating system: Windows 10/8/7/ Vista/XP, MacOS X ver. 10.1.2 or higher

|       |    |  |  |                 |
|-------|----|--|--|-----------------|
| 16 GB |    |  |  | <b>00173303</b> |
|       | 50 |  |  |                 |



## SanDisk

### Cruzer Blade 16GB Electric Green

|          |                  |
|----------|------------------|
| Material | Plastic Material |
|----------|------------------|

- Removable USB 2.0 storage medium (downward compatible with USB 1.1)
- Includes SanDisk SecureAccess software (download necessary): protects your private files in an encrypted, password protected folder (128-bit AES encryption)
- Operating system: Windows 10/8/7/ Vista/XP, MacOS X ver. 10.1.2 or higher

|       |    |  |  |                 |
|-------|----|--|--|-----------------|
| 16 GB |    |  |  | <b>00173304</b> |
|       | 50 |  |  |                 |



## SanDisk

### USB Memory Stick "Extreme Pro", Black

|                         |          |
|-------------------------|----------|
| Transfer Rate (Reading) | 420 MB/s |
| Material                | Metal    |

- Super-fast solid state performance in a USB 3.2 flash drive
- Extreme fast transfer speeds up to 420 MB/s read and 380 MB/s write
- Sophisticated, stylish design with durable aluminium metal casing
- Backward-compatible with USB 3.0 and USB 2.0 ports
- Password protection and 128-bit AES file encryption software
- RescuePRO Deluxe data recovery software download offer
- Operating system: Windows 10/8/7/ Vista, Linux, MacOS X version 10.1.2 or higher

|        |    |    |  |                 |
|--------|----|----|--|-----------------|
| 256 GB |    |    |  | <b>00173414</b> |
|        | 25 | HB |  |                 |
| 128 GB |    |    |  | <b>00173413</b> |
|        | 25 | HB |  |                 |

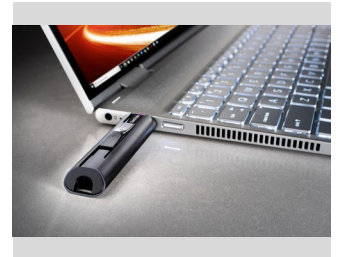

## SanDisk

### USB Memory Stick "Extreme Pro, USB 3.2", Black

|                         |                         |
|-------------------------|-------------------------|
| Transfer Rate (Reading) | 420 MB/s                |
| Transfer Rate (Writing) | 380 MB/s                |
| Material                | Metal, Plastic Material |

- Super-fast solid state performance in a USB 3.1 flash drive
- Extreme fast transfer speeds up to 420 MB/s read and 380 MB/s write
- Sophisticated, stylish design with durable aluminium metal casing
- Backward-compatible with USB 3.0 and USB 2.0 ports
- Password protection and 128-bit AES file encryption software
- RescuePRO Deluxe data recovery software download offer

|        |    |    |  |                 |
|--------|----|----|--|-----------------|
| 512 GB |    |    |  | <b>00186528</b> |
|        | 25 | BK |  |                 |

# Storage Media

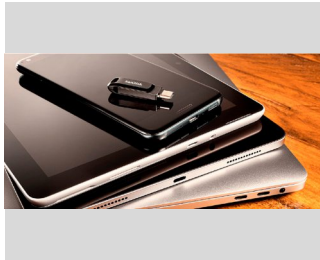

**SanDisk**

## USB Memory Stick "Ultra Dual Flash Drive Go, Type C", Black

|                         |                  |
|-------------------------|------------------|
| Transfer Rate (Reading) | 150 MB/s         |
| Material                | Plastic Material |

- Highspeed Flash-Drive with USB-C and USB-A 3.1 Gen 1 connection
- Free up space on your smartphone or tablet
- Shoot videos and pictures directly onto the Dual Drive Go
- Automatically back up new photos and videos with the SanDisk Memory zone App (free download available)
- Quickly move content to your computer thanks to the USB 3.1 Gen 1 connectors
- Backward-compatible with USB 2.0 ports
- Protect files with individual password
- Rotatable design with key ring for attachment to a keychain and protection of the connectors
- USB-C: Smartphones, tablets, and other host devices with USB-C ports
- USB-A: Windows 7, Windows 8, Windows 10, Mac OS X v10.9+

|        |    |    |  |                 |
|--------|----|----|--|-----------------|
| 512 GB |    |    |  | <b>00186488</b> |
|        | 25 | BK |  |                 |
| 256 GB |    |    |  | <b>00183599</b> |
|        | 25 | BK |  |                 |
| 128 GB |    |    |  | <b>00183598</b> |
|        | 25 | BK |  |                 |
| 64 GB  |    |    |  | <b>00183597</b> |
|        | 50 | BK |  |                 |
| 32 GB  |    |    |  | <b>00183596</b> |
|        | 50 | BK |  |                 |

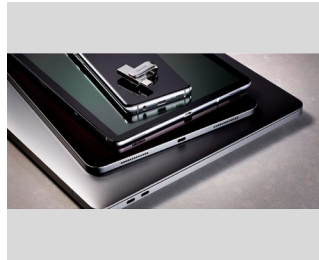

**SanDisk**

## USB Memory Stick "Ultra Dual Luxe, USB 3.1 Gen. 1", Silver

|                         |          |
|-------------------------|----------|
| Transfer Rate (Reading) | 150 MB/s |
| Material                | Metal    |

- Highspeed-Flash-Drive with USB-C and USB-A 3.1-Gen. 1 connection
- Free up space on your smartphone or tablet
- Shoot videos and pictures directly onto the Dual Drive Luxe
- Automatically back up new photos and videos with the SanDisk Memory zone App (free download available)
- Quickly move content to your computer thanks to the USB 3.1 Gen 1 connector
- Backward-compatible with USB 2.0 ports
- Protect files with individual password
- Rotatable, stylish metal design with key ring for attachment to a keychain and protection of the connectors
- USB-A: Operating system: Windows 10/8/7, Mac OS X v10.9+
- USB-C: OTG-ready smartphones, tablets, and other host devices with USB-C ports

|        |    |    |  |                 |
|--------|----|----|--|-----------------|
| 1 TB   |    |    |  | <b>00186467</b> |
|        | 25 | BK |  |                 |
| 256 GB |    |    |  | <b>00186465</b> |
|        | 25 | BK |  |                 |
| 128 GB |    |    |  | <b>00186464</b> |
|        | 25 | BK |  |                 |
| 64 GB  |    |    |  | <b>00186463</b> |
|        | 50 | BK |  |                 |
| 32 GB  |    |    |  | <b>00186462</b> |
|        | 50 | BK |  |                 |



**SanDisk**

## USB Memory Stick "Ultra Flair", Blue, Silver

|                         |                   |
|-------------------------|-------------------|
| Transfer Rate (Reading) | 150 MB/s          |
| Material                | Brushed Aluminium |

- Highspeed USB 3.2 (Gen 1) Flash-Drive
- Ultra fast transfer speeds up to 400 MB/s read
- Elegant, full cast metal design to protect your files from the outside
- Backward-compatible with USB 3.0 and USB 2.0 ports
- pPassword protection and 128-bit AES file encryption software
- RescuePRO Deluxe data recovery software download offer

|        |    |    |  |                 |
|--------|----|----|--|-----------------|
| 128 GB |    |    |  | <b>00173481</b> |
|        | 50 | BK |  |                 |
| 64 GB  |    |    |  | <b>00173480</b> |
|        | 50 | BK |  |                 |
| 32 GB  |    |    |  | <b>00173479</b> |
|        | 50 | BK |  |                 |



**SanDisk**

## USB Memory Stick "Ultra Luxe, USB 3.1", Silver

|                         |          |
|-------------------------|----------|
| Transfer Rate (Reading) | 150 MB/s |
| Material                | Metal    |

- Highspeed USB 3.2 (Gen 1) Flash-Drive
- Ultra fast transfer speeds up to 400 MB/s read
- Elegant, full cast metal design to protect your files from the outside
- Backward-compatible with USB 3.0 and USB 2.0 ports
- pPassword protection and 128-bit AES file encryption software
- RescuePRO Deluxe data recovery software download offer

|        |    |    |  |                 |
|--------|----|----|--|-----------------|
| 512 GB |    |    |  | <b>00186478</b> |
|        | 50 | BK |  |                 |
| 256 GB |    |    |  | <b>00183582</b> |
|        | 50 | BK |  |                 |
| 128 GB |    |    |  | <b>00183581</b> |
|        | 50 | BK |  |                 |
| 64 GB  |    |    |  | <b>00183580</b> |
|        | 50 | BK |  |                 |
| 32 GB  |    |    |  | <b>00183579</b> |
|        | 50 | BK |  |                 |



STORAGE MEDIA & ACCESSORIES





## SanDisk

### USB Memory Stick "Ultra, USB Type-C, Flash Drive", Black

|                         |                  |
|-------------------------|------------------|
| Transfer Rate (Reading) | 150 MB/s         |
| Material                | Plastic Material |

- Highspeed Flash-Drive with USB-C 3.1 Gen 1 connection
- Designed for computer, smartphones and tablets with a USB-C port
- Lightning fast read speeds of up to 150 MB/s
- Automatically back up new photos and videos with the SanDisk Memory Zone App (free download available)
- Quickly move content to your computer thanks to the USB 3.1 Gen 1 connectors
- Backward-compatible with USB 2.0 ports
- Protect files with individual password
- Extendable design with key ring for attachment to a keychain and protection of the connector
- Operating system: Windows 10/8/7, Mac OS X v10.9+
- OTG-ready smartphones, tablets, and other host devices with USB-C ports

|        |          |
|--------|----------|
| 512 GB | 00186458 |
| 256 GB | 00186457 |
| 128 GB | 00186456 |
| 64 GB  | 00186455 |



## SanDisk

### USB Memory Stick "Ultra Fit", Black

|                         |                  |
|-------------------------|------------------|
| Transfer Rate (Reading) | 130 MB/s         |
| Material                | Plastic Material |

- Ultra-small and flat high-speed USB 3.2 (Gen 1) flash drive
- Ultra fast read speeds of up to 400 MB/s
- Plug-and-stay storage for notebooks, tablets, TVs, gaming consoles, car audio systems, and more
- Backward-compatible with USB 3.0 and USB 2.0 ports
- Password protection and 128-bit AES file encryption software
- RescuePRO Deluxe data recovery software download offer

|        |          |
|--------|----------|
| 512 GB | 00186479 |
| 256 GB | 00173489 |
| 128 GB | 00173488 |
| 64 GB  | 00173487 |
| 32 GB  | 00173486 |
| 16 GB  | 00173485 |

## SanDisk

### Ultra 64 GB, USB 3.0, 130 MB/s, set of 2, red/blue

|                         |                  |
|-------------------------|------------------|
| Transfer Rate (Reading) | 130 MB/s         |
| Transfer Rate (Writing) | 130 MB/s         |
| Material                | Plastic Material |

|       |          |
|-------|----------|
| 64 GB | 00121527 |
|-------|----------|



## SanDisk

### USB Memory Stick „Cruzer Ultra Eco, USB 3.2, Gen 1, 5 years warranty“, Turquoise

|                         |                  |
|-------------------------|------------------|
| Transfer Rate (Reading) | 100 MB/s         |
| Material                | Plastic Material |

- Highspeed USB 3.2 (Gen. 1) Flash-Drive
- Transfer large files fast with read speeds up to 100MB/s
- Housing made with over 70% recycled plastic
- Compact design with a built-in keyring loop to take your content on the go
- Backward-compatible with USB 3.0 and USB 2.0 ports
- RescuePro Deluxe data recovery software download offer

|        |          |
|--------|----------|
| 512 GB | 00215447 |
| 256 GB | 00215446 |
| 128 GB | 00215445 |
| 64 GB  | 00215444 |



STORAGE MEDIA & ACCESSORIES



**SanDisk**

**USB Memory Stick  
"Ultra Curve Flash Drive, USB 3.2", Black**

|                         |                  |
|-------------------------|------------------|
| Transfer Rate (Reading) | 100 MB/s         |
| Material                | Plastic Material |

- Highspeed USB 3.2 (Gen 1) Flash-Drive
- Transfer large files fast with read speeds up to 100MB/s
- Compact design with a built-in keyring loop to take your content on the go
- Backward-compatible with USB 3.0 and USB 2.0 ports
- RescuePro Deluxe data recovery software download offer

|        |                 |
|--------|-----------------|
| 512 GB | <b>00215467</b> |
| 50 BK  |                 |



**SanDisk**

**Cruizer Ultra, 32 GB, USB 3.0, 100 MB/s, set of 2, red/blue**

|                         |                  |
|-------------------------|------------------|
| Transfer Rate (Reading) | 100 MB/s         |
| Material                | Plastic Material |

|       |                 |
|-------|-----------------|
| 32 GB | <b>00186454</b> |
| 50 BK |                 |

Label



**hama**

**Memory Card Labels,  
18 pieces, black/white**

|              |          |
|--------------|----------|
| Suitable for | SD & MMC |
|--------------|----------|

- Self-adhesive

|        |                 |
|--------|-----------------|
|        | <b>00095916</b> |
| 100 HC |                 |

# Slide



# Storage Systems | Mounting of slides & Projection

## Storage Sleeve



**hama**

**Slide Sleeves for 20 Framed Slides in 5x5 cm Format, 25 pcs.**

|                             |                    |
|-----------------------------|--------------------|
| Material                    | Polypropylene (PP) |
| Model                       | Slide Cover        |
| Number of Slides per Sleeve | 20                 |

- Safe storage: to protect your valuable slides from external influences such as dust and light and moisture
- Individual storage: Compile slides according to image sequence or theme, for example
- Tidy storage: one slide mount per pocket, filled from the top

|  |    |  |                 |
|--|----|--|-----------------|
|  |    |  | <b>00002004</b> |
|  | 12 |  |                 |

## Slide Viewer



**hama**

**"LED" Slide Viewer, 3 x Magnification**

|                           |          |
|---------------------------|----------|
| Max. Magnification Factor | 3        |
| Slide Format              | 5 x 5 cm |
| Power Supply              | Battery  |

- For all slide frames 5 x 5 cm in size
- With LED lighting, for 2 Mignon AA batteries, 1.5 V

|       |   |    |                 |
|-------|---|----|-----------------|
| Black |   |    | <b>00001655</b> |
|       | 6 | HB |                 |

## Slide Magazine



**hama**

**"300" Slide Case, with 6 Magazines for 50 Slides each**

|                 |          |
|-----------------|----------|
| Shade of colour | Black    |
| Slide Format    | 5 x 5 cm |

- Flat, fold-up slide case, stackable
- For 300 5 x 5 slides
- With 6 unit magazines for 50 slide mounts each
- Produced in accordance with DIN standard

|     |   |  |                 |
|-----|---|--|-----------------|
| 300 |   |  | <b>00001090</b> |
|     | 6 |  |                 |

SLIDE



**hama**

**Slide Sleeves for 20 Framed Slides in 5x5 cm Format, 12 pcs.**

|                             |                    |
|-----------------------------|--------------------|
| Material                    | Polypropylene (PP) |
| Model                       | Slide Cover        |
| Number of Slides per Sleeve | 20                 |

- Safe storage: to protect your valuable slides from external influences such as dust and light and moisture
- Individual storage: Compile slides according to image sequence or theme, for example
- Tidy storage: one slide mount per pocket, filled from the top

|  |    |  |                 |
|--|----|--|-----------------|
|  |    |  | <b>00002014</b> |
|  | 12 |  |                 |

# Cinefilm & Video



# Projectors | Adhesive Material

## Telescreen



**hama**

### Telescreen "Videotransfer"

|                  |       |
|------------------|-------|
| Height of Screen | 20 cm |
| Width of Screen  | 20 cm |

- Surface-reflective deflecting mirror for true-to-side images
- Also for viewing slides without darkening a room: slide image is displayed on the screen
- Easy to use: open the mirror up at an angle of 45° to the screen and direct the projector towards the mirror. The image is projected on the screen via the mirror and can easily be filmed.
- Can compactly be folded up

|       |   |    |  |                 |
|-------|---|----|--|-----------------|
| Black |   |    |  | <b>00003012</b> |
|       | 7 | SC |  |                 |

## Video Cassette Adapter



**hama**

### VHS-C/VHS "Auto" Cassette Adapter

|                     |       |
|---------------------|-------|
| Type Tape ( invoer) | VHS-C |
| Uitvoer             | VHS   |

- Suitable for VHS-C/S-VHS-C
- Includes a motor for automatically tautening the video tape
- Battery operated via 1x Mignon AA 1.5 V (not included)

|  |   |    |  |                 |
|--|---|----|--|-----------------|
|  |   |    |  | <b>00044704</b> |
|  | 6 | HB |  |                 |

## Adhesive Foil

**hama**

### Cinekett S8 Roll with 4000 Pcs.

|  |    |  |  |                 |
|--|----|--|--|-----------------|
|  |    |  |  | <b>00029307</b> |
|  | 20 |  |  |                 |



**hama**

### Cinekett S 8 Splicing Tape, 1 Soundtrack Free

- Pastes over 4 images
- With cut-out for 1 soundtrack

|  |    |    |  |                 |
|--|----|----|--|-----------------|
|  |    |    |  | <b>00003755</b> |
|  | 30 | HB |  |                 |

# Projection



# Projectors

## Projection Screen



**hama**

**Roller Projection Screen,  
240 x 200 cm, 4:3**

|                     |              |
|---------------------|--------------|
| Black Border        | 0 cm         |
| Gain-Value          | 1.2          |
| Material Tube Body  | Aluminium    |
| Cloth Thickness     | 290 µm       |
| Format              | 4:3          |
| Projection Area     | 240 x 200 cm |
| Projection Diagonal | 312.41 cm    |
| Weight              | 9.215 kg     |

- High-quality projection screen which has especially been designed for home cinema use
- Also suitable for business and courses of studies
- Screen with high luminance and a large viewing angle of 150°
- Balancer mechanism for rolling the screen quickly and easily up and out
- Secure height adjustment via the continuously adjustable locking system
- For wall and ceiling mounting
- Aspect ratio: 4:3
- RAL 9010 metal casing with black caps

|     |   |      |  |                 |
|-----|---|------|--|-----------------|
| PVC |   |      |  | <b>00017798</b> |
|     | 1 | K.A. |  |                 |



**hama**

**Roller Projection Screen,  
200 x 150 cm, 16:9**

|                     |              |
|---------------------|--------------|
| Black Border        | 5 cm         |
| Gain-Value          | 1.2          |
| Material Tube Body  | Metal        |
| Cloth Thickness     | 330 µm       |
| Format              | 16:9         |
| Projection Area     | 190 x 107 cm |
| Projection Diagonal | 218 cm       |
| Weight              | 7.28 kg      |

- High-quality projection screen, especially developed for the home cinema
- Projection screen surface with high luminance and large viewing angle of 150°
- For mounting on ceilings or walls
- Spring balancer mechanism for quick and frictionless rolling in and out of the projection cloth
- With tension rod
- With black masking for enhanced picture contrast (5 cm)
- Safe height setting via steplessly adjustable locking system
- Quality of the screen surface: M1 (PVC)
- Aspect ratio: 16:9
- Optimal adjustment of the projection height trough 40 cm wide, black trail
- Compact housing cross section: 7.3 x 8.5 cm
- Black, light-proof backside
- Metal housing RAL 9010 with black end caps

|     |   |      |  |                 |
|-----|---|------|--|-----------------|
| PVC |   |      |  | <b>00018783</b> |
|     | 1 | K.A. |  |                 |

**hama**

**Screen with tripod, 125 x  
125 cm, 2-in-1, mobile set,  
telescopic tube, white**

|                     |              |
|---------------------|--------------|
| Gain-Value          | 1.1          |
| Material Tube Body  | Metal        |
| Cloth Thickness     | 380 µm       |
| Format              | 1:1 Standard |
| Projection Area     | 125 x 125 cm |
| Projection Diagonal | 177 cm       |
| Weight              | 6 kg         |

- The tripod projection screen with quick-release clip can be removed from the tripod and hung up on its own
- The spring mechanism allows the screen to be easily extended to the required size and secured in place, remaining crease-free in the process
- Steplessly adjustable telescopic tube
- white PVC screen for unique colour brilliance and the finest contrast richness for rooms to be darkened
- transportable tripod screen sized 125 cm x 125 cm - Format 1:1
- black metal tube with a diameter of approx. 5.5 cm
- quick setup and disassembly of the screen and stand in a few seconds
- Usefully shaped plastic handle with locking lever
- Stable tripod with non-slip plastic foot caps
- Can be stowed and transported in a space-saving manner
- black, opaque back side

|     |   |    |  |                 |
|-----|---|----|--|-----------------|
| PVC |   |    |  | <b>00021575</b> |
|     | 1 | SC |  |                 |

**hama**

**Screen with tripod, 155 x  
155 cm, 2-in-1, mobile set,  
telescopic tube, white**

|                     |              |
|---------------------|--------------|
| Gain-Value          | 1.1          |
| Material Tube Body  | Metal        |
| Cloth Thickness     | 380 µm       |
| Format              | 1:1 Standard |
| Projection Area     | 155 x 155 cm |
| Projection Diagonal | 219 cm       |
| Weight              | 7.5 kg       |

- The tripod projection screen with quick-release clip can be removed from the tripod and hung up on its own
- The spring mechanism allows the screen to be easily extended to the required size and secured in place, remaining crease-free in the process
- Steplessly adjustable telescopic tube
- white PVC screen for unique colour brilliance and the finest contrast richness for rooms to be darkened
- transportable tripod screen sized 155 cm x 155 cm - Format 1:1
- black metal tube with a diameter of approx. 5.5 cm
- quick setup and disassembly of the screen and stand in a few seconds
- Usefully shaped plastic handle with locking lever
- Stable tripod with non-slip plastic foot caps
- Can be stowed and transported in a space-saving manner
- black, opaque back side

|     |   |    |  |                 |
|-----|---|----|--|-----------------|
| PVC |   |    |  | <b>00021574</b> |
|     | 1 | SC |  |                 |

PROJECTION



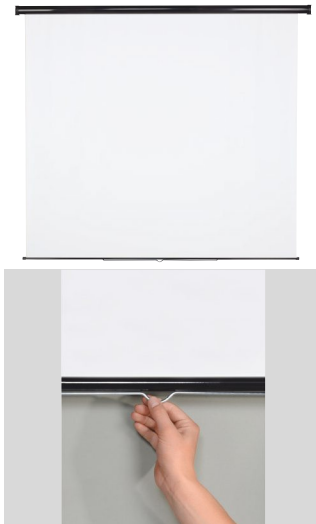

**hama**

**"Slim" Roller Projection Screen, 175 x 175 cm, 1:1**

|                     |              |
|---------------------|--------------|
| Black Border        | 0 cm         |
| Gain-Value          | 1.1          |
| Material Tube Body  | Aluminium    |
| Cloth Thickness     | 280 µm       |
| Format              | 1:1 Standard |
| Projection Area     | 175 x 175 cm |
| Projection Diagonal | 247 cm       |
| Weight              | 4.36 kg      |

- White PVC screen for unique colour brilliance and very fine contrasts, the optimum for rooms with normal illumination and without direct light incidence
- Lightweight projection screen for easy wall and ceiling mounting
- Screen with high luminance and a large viewing angle of 150°
- Therefore ideal for home cinema applications
- Aspect ratio 1:1
- Secure height adjustment via continuously adjustable locking system
- Black, light proof back
- Black metal tube with a diameter of about 5,7 cm

|     |  |   |      |  |                 |
|-----|--|---|------|--|-----------------|
| PVC |  |   |      |  | <b>00018748</b> |
|     |  | 1 | K.A. |  |                 |

**hama**

**Roll-up screen, 175 x 175 cm, mobile, for ceiling or wall mounting, white**

|                     |              |
|---------------------|--------------|
| Black Border        | 3 cm         |
| Gain-Value          | 1.1          |
| Material Tube Body  | Metal        |
| Cloth Thickness     | 380 µm       |
| Format              | 1:1 Standard |
| Projection Area     | 175 x 175 cm |
| Projection Diagonal | 247 cm       |
| Weight              | 7 kg         |

- Enjoy the best views: The pull-out screen has a steplessly adjustable blocking system so you can set the image in the perfect screen format – for a real home cinema feel
- lightweight projection screen for quick and easy wall and ceiling mounting
- white PVC screen for unique colour brilliance and the finest contrast richness for rooms to be darkened
- transportable projection screen sized 175 cm x 175 cm
- black metal tube with a diameter of approx. 7 cm
- secure height adjustment via variably adjustable blocking system
- Can be stowed and transported in a space-saving manner
- black, opaque back side
- with black masking (3 cm) for increased image contrast
- aspect ratio 1:1

|     |  |   |    |  |                 |
|-----|--|---|----|--|-----------------|
| PVC |  |   |    |  | <b>00021576</b> |
|     |  | 1 | SC |  |                 |

**hama**

**Screen with tripod, 180 x 180 cm, 2-in-1, mobile set, telescopic tube, white**

|                     |              |
|---------------------|--------------|
| Gain-Value          | 1.1          |
| Material Tube Body  | Metal        |
| Cloth Thickness     | 380 µm       |
| Format              | 1:1 Standard |
| Projection Area     | 180 x 180 cm |
| Projection Diagonal | 255 cm       |
| Weight              | 9 kg         |

- The tripod projection screen with quick-release clip can be removed from the tripod and hung up on its own
- The spring mechanism allows the screen to be easily extended to the required size and secured in place, remaining crease-free in the process
- Steplessly adjustable telescopic tube
- white PVC screen for unique colour brilliance and the finest contrast richness for rooms to be darkened
- transportable tripod screen sized 180 cm x 180 cm - Format 1:1
- black metal tube with a diameter of approx. 5.5 cm
- quick setup and disassembly of the screen and stand in a few seconds
- Usefully shaped plastic handle with locking lever
- Stable tripod with non-slip plastic foot caps
- Can be stowed and transported in a space-saving manner
- black, opaque back side

|     |  |   |    |  |                 |
|-----|--|---|----|--|-----------------|
| PVC |  |   |    |  | <b>00021573</b> |
|     |  | 1 | SC |  |                 |

**Projector Table**



**hama**

**Projector Table with 2 Levels (42 x 50 / 40 x 35 cm), Height-Adjustable, wi**

|              |       |
|--------------|-------|
| Maximum Load | 10 kg |
|--------------|-------|

- Dynamic presentations: with two highly flexible platforms that can be adjusted in terms of height, inclination and orientation, you can direct your projector presentation perfectly for your audience
- Flexible use of the two platforms: for projectors and the lower level as a working surface, e.g. for a notebook and documents

|       |  |   |    |                 |
|-------|--|---|----|-----------------|
| Black |  |   |    | <b>00077510</b> |
|       |  | 1 | SC |                 |

PROJECTION

## Laser Pointer



***hama***

### "LP-1R" Laser Pointer, red

|              |       |
|--------------|-------|
| Colour Laser | Red   |
| Max. Range   | 50 m  |
| Diameter     | 12 mm |
| Length       | 67 mm |

- The red laser is ideal for emphasizing important points in darkened surroundings
- Metal housing in a timeless design
- Incl. key ring and snap hook for attachment to bags or key collections
- Laser class 2 less than 1 mW

|                |                 |
|----------------|-----------------|
| Chrome (matte) | <b>00003500</b> |
| 24 HB          |                 |

PROJECTION

# Storage Systeme



# Storage Systems

File



**hama**

Folder for Negatives etc.,  
4 D-rings, Filling Height  
45 mm, with Slipcase

| Binding            | Art Print (Laminated) |
|--------------------|-----------------------|
| Mechanics          | 4 Ring Mechanic       |
| Format             | 29 x 32.5 cm          |
| Maximum Sheet Size | 260 x 310 mm          |
| Spine Width        | 80 mm                 |

- Stable and lots of space: handy storage option for photographs, negatives, slides and much more
- Safe storage: for protection against external influences such as dust, light and moisture

|      |          |
|------|----------|
| Grey | 00002298 |
|      | 7        |



**hama**

File  
"4-ring combination mecha-  
nism, 39 mm spine width"

| Binding     | Art Print (Laminated)        |
|-------------|------------------------------|
| Mechanics   | 4-Ring combination mechanism |
| Format      | 29 x 32.5 cm                 |
| Spine Width | 39 mm                        |

- Stable and lots of space: handy storage option for photographs, negatives or slides
- Safe storage: for protection against external influences such as dust, light and moisture

|      |          |
|------|----------|
| Pink | 00007552 |
|      | 34       |



**hama**

File  
"4-ring combination mecha-  
nism, 39 mm spine width"

| Binding     | Art Print (Laminated)        |
|-------------|------------------------------|
| Mechanics   | 4-Ring combination mechanism |
| Format      | 29 x 32.5 cm                 |
| Spine Width | 39 mm                        |

- Stable and lots of space: handy storage option for photographs, negatives or slides
- Safe storage: for protection against external influences such as dust, light and moisture

|       |          |
|-------|----------|
| Green | 00007550 |
|       | 34       |



**hama**

File  
"4-D ring mechanism, 70 mm  
spine width, with slipcase"

| Binding     | Art Print (Laminated)        |
|-------------|------------------------------|
| Mechanics   | 4-Ring combination mechanism |
| Format      | 33,5 x 31 cm                 |
| Spine Width | 77 mm                        |

- FSC Mix: responsibly sourced paper

|             |          |
|-------------|----------|
| Black, Grey | 00007546 |
| White       | 00007547 |
|             | 7        |



**hama**

File  
"4-ring combination mecha-  
nism, 39 mm spine width"

| Binding     | Art Print (Laminated)        |
|-------------|------------------------------|
| Mechanics   | 4-Ring combination mechanism |
| Format      | 29 x 32.5 cm                 |
| Spine Width | 39 mm                        |

- Stable and lots of space: handy storage option for photographs, negatives or slides
- Safe storage: for protection against external influences such as dust, light or moisture

|        |          |
|--------|----------|
| Yellow | 00007549 |
|        | 34       |



**hama**

File  
"4-ring combination mecha-  
nism, 39 mm spine width"

| Binding     | Art Print (Laminated)        |
|-------------|------------------------------|
| Mechanics   | 4-Ring combination mechanism |
| Format      | 29 x 32.5 cm                 |
| Spine Width | 39 mm                        |

- Stable and lots of space: handy storage option for photographs, negatives or slides
- Safe storage: for protection against external influences such as dust, light and moisture

|      |          |
|------|----------|
| Blue | 00007551 |
|      | 34       |

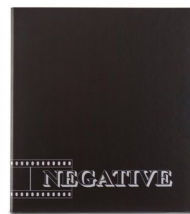

**hama**

"Negatives" Folder with  
4-Ring Combi Mechanism,  
39 mm Spine Width, black

| Binding     | Art Print (Laminated)        |
|-------------|------------------------------|
| Mechanics   | 4-Ring combination mechanism |
| Format      | 29 x 32.5 cm                 |
| Spine Width | 39 mm                        |

- Stable and lots of space: handy storage option for photographs, negatives or slides
- Safe storage: for protection against external influences such as dust, light and moisture

|       |          |
|-------|----------|
| Black | 00007548 |
|       | 34       |

STORAGE SYSTEMS

## Storage Sleeve



**hama**

**Slide Sleeves for 20 Framed Slides in 5x5 cm Format, 25 pcs.**

|                             |                    |
|-----------------------------|--------------------|
| Material                    | Polypropylene (PP) |
| Model                       | Slide Cover        |
| Number of Slides per Sleeve | 20                 |

- Safe storage: to protect your valuable slides from external influences such as dust and light and moisture
- Individual storage: Compile slides according to image sequence or theme, for example
- Tidy storage: one slide mount per pocket, filled from the top

|          |  |
|----------|--|
| 00002004 |  |
| 12       |  |



**hama**

**Slide Sleeves for 20 Framed Slides in 5x5 cm Format, 12 pcs.**

|                             |                    |
|-----------------------------|--------------------|
| Material                    | Polypropylene (PP) |
| Model                       | Slide Cover        |
| Number of Slides per Sleeve | 20                 |

- Safe storage: to protect your valuable slides from external influences such as dust and light and moisture
- Individual storage: Compile slides according to image sequence or theme, for example
- Tidy storage: one slide mount per pocket, filled from the top

|          |  |
|----------|--|
| 00002014 |  |
| 12       |  |



**hama**

**Photo Sleeves, DIN A4, 4-8 Photos with a Size of 10x15 cm, clear, 10 Pcs.**

|                             |                    |
|-----------------------------|--------------------|
| Shade of colour             | Transparent        |
| Format                      | Vertical Format    |
| Material                    | Polypropylene (PP) |
| Model                       | Photo Sleeve       |
| Number of Photos per Sleeve | 8                  |
| Picture Size                | 10 x 15 cm         |

- Safe storage: for protection of photos against external influences such as dust, light and moisture

|          |    |
|----------|----|
| 00009777 |    |
| 18       | HC |



**hama**

**Photo Sleeves, DIN A4, for 8 Photos with a Size of 10x15 cm, white, 10 Pcs.**

|                             |                    |
|-----------------------------|--------------------|
| Shade of colour             | White              |
| Format                      | Vertical Format    |
| Material                    | Polypropylene (PP) |
| Model                       | Photo Sleeve       |
| Number of Photos per Sleeve | 8                  |
| Picture Size                | 10 x 15 cm         |

- Safe storage: for protection of photos against external influences such as dust, light and moisture

|          |    |
|----------|----|
| 00009787 |    |
| 12       | HC |

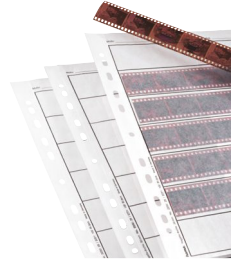

**hama**

**Negative Sleeves, Parchment, 7 Strips of 6 Negatives, 24x36 mm, 100 pcs.**

|                                |                     |
|--------------------------------|---------------------|
| Material                       | Glassine Matt (PER) |
| Model                          | Negative Sleeve     |
| Number of Negatives per Sleeve | 42                  |

- Safe storage: to protect your valuable negatives from external influences such as dust, light and moisture
- Individual storage: compile negatives according to themes, for example
- Tidy storage: one strip per pocket, filled from the side
- Better visibility than in conventional photo print envelopes

|          |    |
|----------|----|
| 00002251 |    |
| 14       | SC |

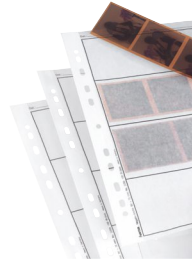

**hama**

**Negative Sleeves, Parchment, 4 Strips of 3 Negatives, 6x7 cm, 100 pcs.**

|                                |                     |
|--------------------------------|---------------------|
| Material                       | Glassine Matt (PER) |
| Model                          | Negative Sleeve     |
| Number of Negatives per Sleeve | 12                  |

- Safe storage: to protect your valuable negatives from external influences such as dust, light and moisture
- Individual storage: compile negatives according to themes, for example
- Tidy storage: one strip per pocket, filled from the side
- Better visibility than in conventional photo print envelopes

|          |    |
|----------|----|
| 00002259 |    |
| 14       | SC |

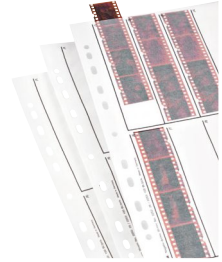

**hama**

**Negative Sleeves, Parchment, 10 Strips of 4 Negatives, 24x36 mm, 25 pcs.**

|                                |                     |
|--------------------------------|---------------------|
| Material                       | Glassine Matt (PER) |
| Model                          | Negative Sleeve     |
| Number of Negatives per Sleeve | 40                  |

- Safe storage: to protect your valuable negatives from external influences such as dust, light and moisture
- Individual storage: compile negatives according to themes, for example
- Tidy storage: one strip per pocket, filled from the side
- Better visibility than in conventional photo print envelopes

|          |    |
|----------|----|
| 00002252 |    |
| 10       | PO |

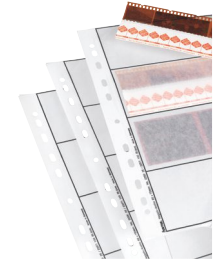

**hama**

**Negative Sleeves, Parchment, 4 Strips of 3 Negatives, 6x6 cm, 25 pcs.**

|                                |                     |
|--------------------------------|---------------------|
| Material                       | Glassine Matt (PER) |
| Model                          | Negative Sleeve     |
| Number of Negatives per Sleeve | 12                  |

- Safe storage: to protect your valuable negatives from external influences such as dust, light and moisture
- Individual storage: compile negatives according to themes, for example
- Tidy storage: one strip per pocket, filled from the side
- Better visibility than in conventional photo print envelopes

|          |    |
|----------|----|
| 00002256 |    |
| 15       | PO |

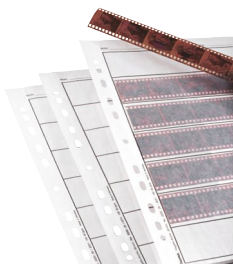

**hama**

**Negative Sleeves, Parchment, 7 Strips of 6 Negatives, 24x36 mm, 25 pcs.**

|                                |                     |
|--------------------------------|---------------------|
| Material                       | Glassine Matt (PER) |
| Model                          | Negative Sleeve     |
| Number of Negatives per Sleeve | 42                  |

- Safe storage: to protect your valuable negatives from external influences such as dust, light and moisture
- Individual storage: compile negatives according to themes, for example
- Tidy storage: one strip per pocket, filled from the side
- Better visibility than in conventional photo print envelopes

|  |    |    |                 |
|--|----|----|-----------------|
|  |    |    | <b>00002250</b> |
|  | 15 | PO |                 |

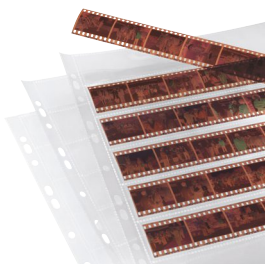

**hama**

**Negative Sleeves, PP, 7 Strips of 6 Negatives, 24x36 mm, 100 pcs.**

|                                |                    |
|--------------------------------|--------------------|
| Material                       | Polypropylene (PP) |
| Model                          | Negative Sleeve    |
| Number of Negatives per Sleeve | 42                 |

- Safe storage: to protect your valuable negatives from external influences such as dust, light and moisture
- Individual storage: compile negatives according to themes, for example
- Tidy storage: one strip per pocket, filled from the side
- Better visibility than in conventional photo print envelopes

|  |   |    |                 |
|--|---|----|-----------------|
|  |   |    | <b>00002051</b> |
|  | 8 | SC |                 |

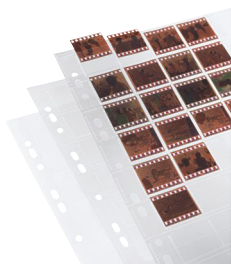

**hama**

**Negative Sleeves, PP, 1 Sheet for 40 Individual Negatives, 24x36 mm, 25 pcs.**

|                                |                    |
|--------------------------------|--------------------|
| Material                       | Polypropylene (PP) |
| Model                          | Negative Sleeve    |
| Number of Negatives per Sleeve | 40                 |

- Safe storage: to protect your valuable negatives from external influences such as dust, light and moisture
- Individual storage: compile negatives according to image sequence or theme, for example, such as for self-cut negatives
- Tidy storage: one negative per pocket, filled from the top

|  |    |  |                 |
|--|----|--|-----------------|
|  |    |  | <b>00002032</b> |
|  | 12 |  |                 |

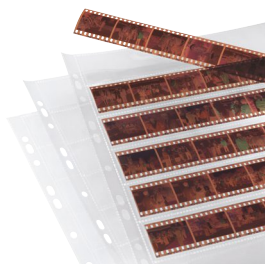

**hama**

**Negative Sleeves, PP, 7 Strips of 6 Negatives, 24x36 mm, 25 pcs.**

|                                |                    |
|--------------------------------|--------------------|
| Material                       | Polypropylene (PP) |
| Model                          | Negative Sleeve    |
| Number of Negatives per Sleeve | 42                 |

- Safe storage: to protect your valuable negatives from external influences such as dust, light and moisture
- Individual storage: compile negatives according to themes, for example
- Tidy storage: one strip per pocket, filled from the side
- Better visibility than in conventional photo print envelopes

|  |    |  |                 |
|--|----|--|-----------------|
|  |    |  | <b>00002050</b> |
|  | 10 |  |                 |

## Album Sheets

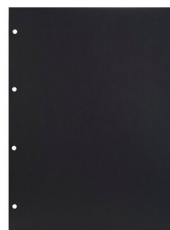

**hama**

**Album Sheets "23.3x31 cm, punched, 25 sheets"**

|      |              |
|------|--------------|
| Size | 233 x 310 mm |
|------|--------------|

- FSC Mix: responsibly sourced paper
- Photo cardboard can be used on both sides
- Ideal for sticking things in, ideal for classic photo archiving
- Lots of space for pictures and flat souvenirs (tickets, maps, coins, etc.) of various sizes
- Handy Euro punch holes: filing margin punched 4 x
- For personalised arrangement and creative design of the pages

|       |                 |
|-------|-----------------|
| White | <b>00007555</b> |
| Black | <b>00007553</b> |
|       | 48              |



**hama**

**Album Sheets "with glassine, 23.3x31 cm, punched, 25 sheets"**

|      |              |
|------|--------------|
| Size | 233 x 310 mm |
|------|--------------|

- FSC Mix: responsibly sourced paper
- Photo cardboard can be used on both sides
- Ideal for sticking things in, ideal for classic photo archiving
- Lots of space for pictures and flat souvenirs (tickets, maps, coins, etc.) of various sizes
- Handy Euro punch holes: filing margin punched 4 x
- For personalised arrangement and creative design of the pages
- With separating pages: the intermediate parchment pages offer ideal protection for your favourite pictures

|       |                 |
|-------|-----------------|
| White | <b>00007556</b> |
| Black | <b>00007554</b> |
|       | 36              |

# Cutting Machines

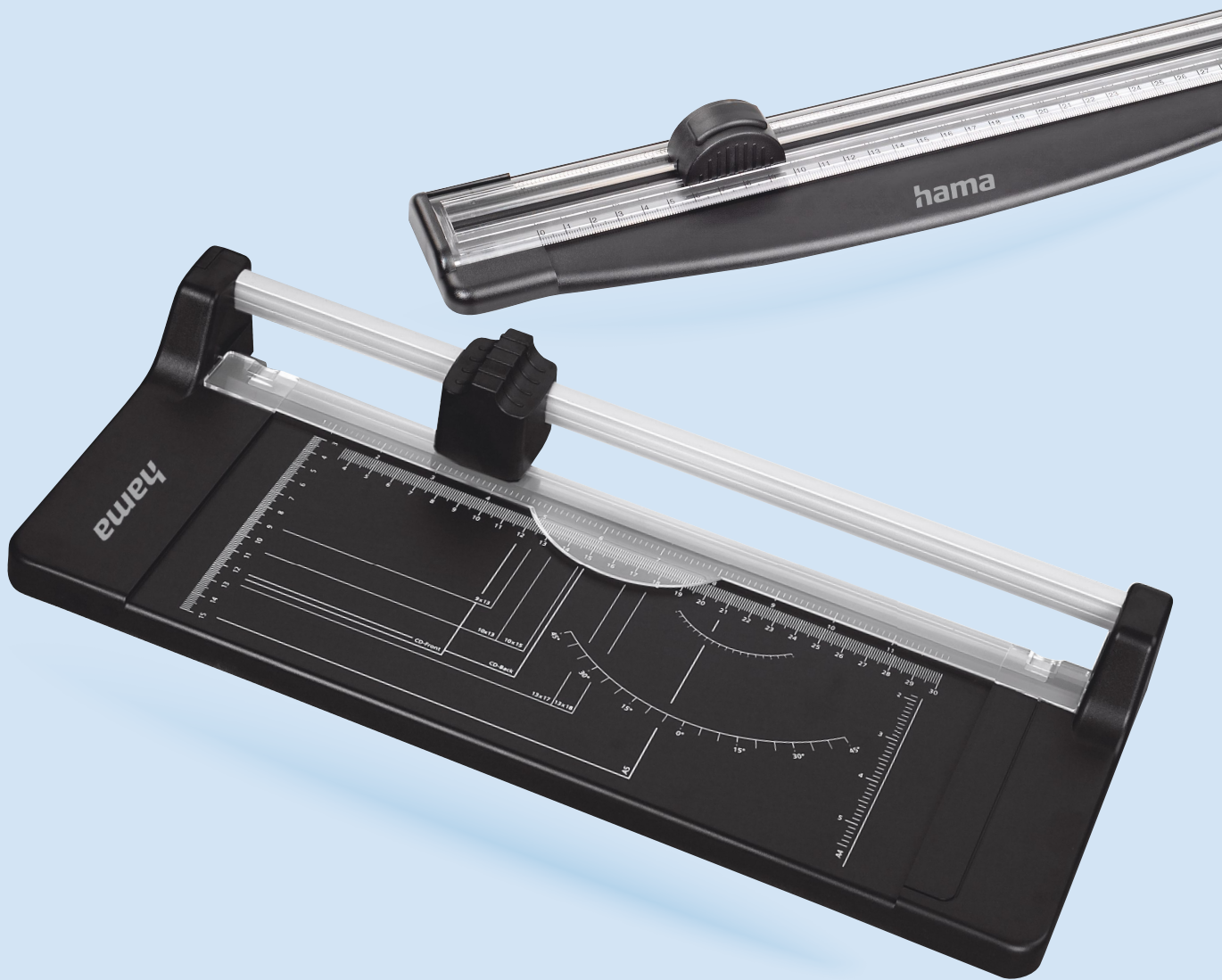

Cutting Machine/accessories

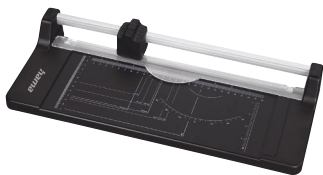

**hama**

"Easy Cut R 320" Rotary Trimmer

|              |                        |
|--------------|------------------------|
| Cut Height   | 0.5 mm                 |
| Cut Length   | 320 mm                 |
| Sheet Format | DIN A4, DIN A5, DIN A6 |

- Circular blade made of hardened steel
- Transparent clamping ruler
- Guide bar made of aluminium
- Interchangeable cutting head
- Scale for analogue and digital foto/DIN formats and CD/DVD covers
- Angle lines for angular cutting in 5° steps
- Cutting height: max. 5 sheets 80 g/m<sup>2</sup> (0.5 mm)



**hama**

Lever Cutter "ProCut S 330 Plus"

|              |                        |
|--------------|------------------------|
| Cut Height   | 1 mm                   |
| Cut Length   | 330 mm                 |
| Sheet Format | DIN A4, DIN A5, DIN A6 |

- Lever cutter for paper and foil
- Clamping ruler with protective finger edge for optimal hold of the piece which is to be cut
- Marks on cutting table for analogue and digital picture/DIN formats with scale in CM and inch
- Formats and CD/DVD cover
- Angle lines for angular cutting in 5° steps
- Cutting height: max. 10 sheets 80 g/m<sup>2</sup> (1.0 mm)



**hama**

"ProCut 310" Paper Trimmer

|            |        |
|------------|--------|
| Cut Height | 0.5 mm |
| Cut Length | 310 mm |

- Easy cutting ruler with cutting plate for mobile use
- Safe and straight cut, up to 31 cm, thanks to non-slip rubber feet
- Transparent clamping ruler with measurement division in cm & inch
- High longevity thanks to heat-treated steel blade
- Cutting height: max. 5 sheets 80g/m<sup>2</sup> (0.5 mm)

CUTTING MACHINES

|          |    |  |
|----------|----|--|
| 00008206 |    |  |
| 5        | SC |  |

|          |    |  |
|----------|----|--|
| 00008212 |    |  |
| 5        | SC |  |

|          |    |  |
|----------|----|--|
| 00008224 |    |  |
| 6        | BK |  |



# Photo-Studio



# Monopods & Tripods | Tripod Accessories

## Tripod



**hama**

### Lighting Tripod 200

|                           |               |
|---------------------------|---------------|
| Thread/Connection         | 1/4" (6.4 mm) |
| Leg Segments              | 1 Section     |
| Material                  | Metal         |
| Maximum Load              | 2500 g        |
| Tripod Head               | No            |
| Type                      | Light Stand   |
| Min. Height - Max. Height | 75 -200 cm    |
| Maximum Profile Thickness | 24 mm         |
| Weight                    | 980 g         |

- Stable design thanks to cross-struts
- Functional quick-action leg locks for rapid and simple locking
- Especially lightweight, therefore ideal for shots outside the studio

|       |   |    |  |                 |
|-------|---|----|--|-----------------|
| Black |   |    |  | <b>00004084</b> |
|       | 6 | SC |  |                 |

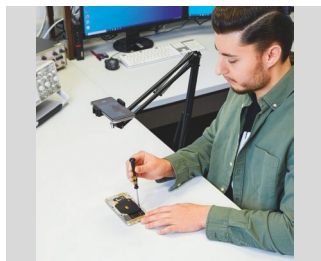

**hama**

### "700 II" Flexible Articulated Arm, 1/4", max. 70 cm, Smartphone Holder, Table Clamp

|                           |                                  |
|---------------------------|----------------------------------|
| Thread/Connection         | 1/4" (6.4 mm), Smartphone holder |
| Leg Segments              | 2 Sections (1x Extendible)       |
| Material                  | Metal                            |
| Tripod Head               | No                               |
| Type                      | Light Stand                      |
| Min. Height - Max. Height | 70 cm                            |
| Weight                    | 468 g                            |

- Adjustable screw clamp for various attachment options: all types of desks, workstations, shelves, bars
- No adapter needed: flexible mobile phone holder for attachment to the articulated arm enclosed, for extraordinary shooting angles and perfects shots for every format
- Vertical and horizontal: ring light, camera, webcam, smartphone or tablet - all of them can be precisely positioned wherever you need them thanks to the two highly flexible joints
- Practical, full-motion holder, ideal for office, kitchen, hobby workshop, influencer/vlogger/blogger/YouTube studio or bedside table
- Maximum length 70 cm
- Allows quick and easy access to the device
- Ideal for taking photographs and making videos, for browsing, watching films or for video chats, but also perfectly suited for use in the office
- Comfortable use: the hands are always free and yet each device is in view or quickly adjusted for another scenario or to prevent it getting in the way

|       |    |    |  |                 |
|-------|----|----|--|-----------------|
| Black |    |    |  | <b>00004660</b> |
|       | 24 | HB |  |                 |

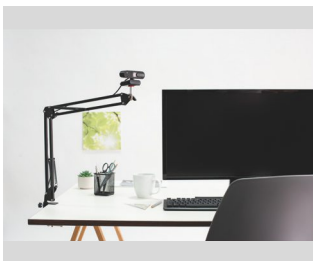

**hama**

### Flexible articulated arm "700", 1/4", max. 70 cm, with table clamp, for ring lamp

|                           |                            |
|---------------------------|----------------------------|
| Thread/Connection         | 1/4" (6.4 mm)              |
| Leg Segments              | 2 Sections (1x Extendible) |
| Material                  | Metal                      |
| Tripod Head               | No                         |
| Type                      | Light Stand                |
| Min. Height - Max. Height | 70 cm                      |
| Weight                    | 450 g                      |

- Adjustable screw clamp for various attachment options: all types of desks, workstations, shelves, bars
- Vertical and horizontal: ring light, camera, webcam, smartphone or tablet - all of them can be precisely positioned wherever you need them thanks to the two highly flexible joints
- Practical, full-motion holder, ideal for office, kitchen, hobby workshop, influencer/vlogger/blogger/YouTube studio or bedside table
- Maximum length 70 cm
- Allows quick and easy access to the device
- Ideal for taking photographs and making videos, for browsing, watching films or for video chats, but also perfectly suited for use in the office
- Comfortable use: the hands are always free and yet each device is in view or quickly adjusted for another scenario or to prevent it getting in the way
- Easy and safe table mounting through adjustable screw clamp made from robust and stable metal, felt protects surfaces
- Spring additionally stabilises the positions of the joints

|       |    |    |  |                 |
|-------|----|----|--|-----------------|
| Black |    |    |  | <b>00004652</b> |
|       | 24 | HB |  |                 |

## Clamp Extensions



**hama**

### "Studio Clamp 40", Set of 3

|       |       |
|-------|-------|
| Shape | Wedge |
|-------|-------|

- Powerful spring clamp
- Support opening: approx. 60 mm, clamping width: approx. 40 mm
- Width: approx. 80 mm

|  |    |    |  |                 |
|--|----|----|--|-----------------|
|  |    |    |  | <b>00021205</b> |
|  | 30 | HB |  |                 |

## Wall Bracket for Background Rolls



**hama**

### Photo Background System for Studio and On the Move, 158 - 295 cm, Extendable

|          |           |
|----------|-----------|
| Material | Aluminium |
| Length   | 295 cm    |
| Weight   | 5.3 kg    |

- Whether it be monochrome, green screen or panoramic landscape: the Hama background tripod set makes working with all common formats for photo backgrounds easier, with or without a roll. You always have all the professional background design options at your fingertips
- Steplessly extendable telescopic bar and tripods: the height and width of the flexible photo background system can be steplessly adjusted for a perfectly coordinated arrangement of the image motif, lighting and background
- Photo studio to go: the portable background system can be packed up extremely small for transport and storage and is a piece of essential equipment for all photographers who like to be flexible and practical
- The handy 2-part telescopic tube makes optimised staging of the main motif easier and allows the rapid exchange of fabric backgrounds and paper backgrounds on rolls
- Transportable and flexible tripods for photo backgrounds from 158 cm to 295 cm in width guarantee professional results in photography and video production
- Creates the ideal conditions for the digital reworking of shots, e.g. for cropping and integrating other background images

|       |          |
|-------|----------|
| Black | 00021202 |
|       | 4 SC     |

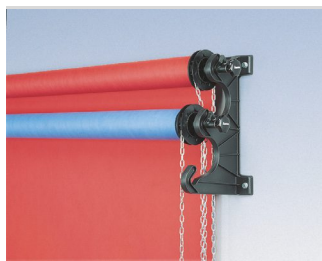

**hama**

### Bracket for Background Rolls, 3x, Hama System

|                 |                  |
|-----------------|------------------|
| Material        | Plastic Material |
| Number of Hooks | 3                |
| Length          | 40 cm            |
| Weight          | 1.04 kg          |

- For 3 background axes with Hama system
- Suitable for insert spindle item no. 00021210, aluminium tube 275 cm item no. 00021211, aluminium tube 360 cm item no. 00021212
- Wall or ceiling mounting
- With mounting screws and dowels
- With drilling template and mounting diagram
- Impact-resistant plastic

|       |          |
|-------|----------|
| Black | 00021200 |
|       | 1 SC     |

## Half Spindle



**hama**

### Background Aluminium Tube Axle, 360 cm, Hama System

|                       |       |
|-----------------------|-------|
| Maximum Load Capacity | 25 kg |
| Weight                | 12 kg |

- For 3x brackets for background rolls, item no. 00021200 System Hama
- The end-to-end aluminium pipes prevent the background cardboard from sagging and therefore creasing
- Unrolling stop
- Metal chain
- Clamp device for cardboard tubes
- Load capacity max. 25 kg
- Weight

|        |          |
|--------|----------|
| 360 cm | 00021212 |
|        | 1 K.A.   |



**hama**

### Background Aluminium Tube Axle, 275 cm, Hama System

|                       |        |
|-----------------------|--------|
| Maximum Load Capacity | 5.5 kg |
| Weight                | 10 kg  |

- For 3x brackets for background rolls, item no. 00021200 System Hama
- The end-to-end aluminium pipes prevent the background cardboard from sagging and therefore creasing
- Unrolling stop
- Metal chain
- Clamp device for cardboard tubes
- Load capacity max. 14 kg
- Weight

|        |          |
|--------|----------|
| 275 cm | 00021211 |
|        | 1 K.A.   |



**hama**

### Background Insert Spindles, 2-Part, Hama System

|                       |        |
|-----------------------|--------|
| Maximum Load Capacity | 5.5 kg |
| Weight                | 2.7 kg |

- For 3x brackets for background rolls, item no. 00021200, System Hama
- Clamp device for cardboard tube
- Unrolling stop
- Metal chain
- The axle parts are pushed into the cardboard tube from the left or right
- Weight
- For roll widths from 80 - 275 cm
- Only for rolls on cardboard core with internal diameter of 54 - 65 mm

|        |          |
|--------|----------|
| 275 cm | 00021210 |
|        | 3 SC     |

## Locking Cone



**hama**

### Background Fixing Cone, Hama System

|          |       |
|----------|-------|
| Material | Metal |
|----------|-------|

- Allows background rolls on cardboard tubing of any width (depending on the axle) to be fixed in place
- Examples: background cardboard 275 cm on axle 360 cm/background axle 135 cm on axle 275 cm
- Securing cuff
- Weight

|      |   |    |  |                 |
|------|---|----|--|-----------------|
| Grey |   |    |  | <b>00021235</b> |
|      | 1 | SC |  |                 |

## Weighting Rail



**hama**

### Weighting rail for all photo backgrounds

|                 |        |
|-----------------|--------|
| Shade of colour | Silver |
|-----------------|--------|

- The rail is attached to the bottom of the background cardboard and keeps it hanging flat or secured to the floor
- 4 fastening clips

|        |   |      |  |                 |
|--------|---|------|--|-----------------|
| 2.75 m |   |      |  | <b>00021213</b> |
|        | 1 | K.A. |  |                 |

## Hook and Loop Tape

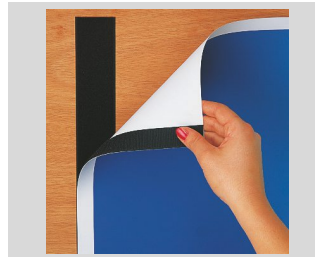

**hama**

### "Studio" Hook and Loop Tape, 2 m

|                 |            |
|-----------------|------------|
| Shade of colour | Black      |
| Material        | Nylon      |
| Width x Length  | 5 x 200 cm |

- 2 m loop tape (width: 50 mm), 2 m hook tape (width: 25 mm)
- Self-adhesive
- Also suitable for fixing decorations

|  |   |    |  |                 |
|--|---|----|--|-----------------|
|  |   |    |  | <b>00022290</b> |
|  | 6 | BK |  |                 |

## Umbrella Holder

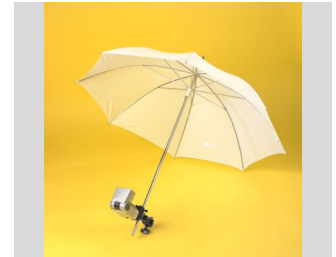

**hama**

### Umbrella Holder for Flash Units with Attachment Foot

|                 |       |
|-----------------|-------|
| Shade of colour | Black |
|-----------------|-------|

- With spigot adapter for use on tripod sockets A 1/4" (6.4 mm)
- Without adapter can be used for larger diameters up to 1.5 cm
- Studio umbrella is attached to the insert hole with a spring, suitable for all common umbrella diameters
- Joint for inclining the flash and umbrella by 90° in both directions
- Standard flash rail with locking screw for secure fixing
- Suitable for all stands up to 1.5 cm

|  |   |    |  |                 |
|--|---|----|--|-----------------|
|  |   |    |  | <b>00006079</b> |
|  | 3 | BK |  |                 |

## Mini Photo Studio



**hama**

### "ToGo" Mobile Mini Photo Studio, Folding Photo Box with LED Ring Light, 50x

|                        |                 |
|------------------------|-----------------|
| Width x Depth x Height | 50 x 50 x 50 cm |
|------------------------|-----------------|

- Foldable photo box: this little mini studio can be folded down to a trim 3 cm in height and takes up barely any space when on the move
- Light box with accessories: the little photo studio including LED ring light, diffuser fabric and colour backgrounds contains everything you need for good product photography
- Take them easily yourself: great product images even without any in-depth knowledge of professional product photography - and without any major costs
- From warm white to daylight bright: control the colour temperature in 3 stages using the cable remote control for optimised and even lighting
- From radiantly bright to pleasantly dimmed: the light intensity can be adjusted in 10 stages
- LED lights are economical and thus more durable than conventional lamps
- Always the right mood: the mobile photo studio set for product photography contains 6 backgrounds to ensure the right colour for every scenario, be it classic white, sleek beige or green
- Photo studio to go: the light box can be packed up extremely small for transport and storage and is a piece of essential equipment for all online traders and photographers who like to be flexible and practical
- Fast light cube setup: simply apply hook-and-loop fastener to the edges and attach them to each other
- Great lighting: integrated ring light with 10.2" (ø 25 cm) and 128 LEDs on the top of the light cube

|  |  |   |    |  |          |
|--|--|---|----|--|----------|
|  |  |   |    |  | 00004664 |
|  |  | 6 | HB |  |          |

## Adhesive Paste



**hama**

### Adhesive Paste, 250 g

- Kneadable
- For support
- Is simply applied to the product
- Neutral grey
- Can be coloured with a felt pen or similar on the surface
- Permanently elastic
- No skin formation
- Does not become brittle
- Self-adhesive

|      |  |    |    |  |          |
|------|--|----|----|--|----------|
| Grey |  |    |    |  | 00007091 |
|      |  | 28 | SC |  |          |

## Matt Spray



**hama**

### Matt Spray

- Wash-out spray
- Can be removed again with water

|        |  |   |  |  |          |
|--------|--|---|--|--|----------|
| 400 ml |  |   |  |  | 00006619 |
|        |  | 6 |  |  |          |

## Photo Background

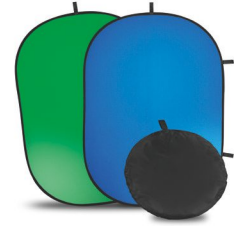

**hama**

### "2in1" Folding Background, Green/Blue, 150 x 200 cm

|                |           |
|----------------|-----------|
| Material       | Cotton    |
| Width x Length | 1.5 x 2 m |

- Mobile folding background for streaming, gaming and video conferences in the office, home office and leisure domain
- Can be set up in seconds
- Two-colour background (green front / blue rear), ideal for photo and video recordings that can be cropped and digitally edited
- With fastening loops (1 x short side / 2 x long side)

|  |  |   |    |  |          |
|--|--|---|----|--|----------|
|  |  |   |    |  | 00021570 |
|  |  | 3 | SC |  |          |



**hama**

### Photo Studio Background, Fabric, 2.95 x 6 m, white

|                |            |
|----------------|------------|
| Material       | Cotton     |
| Width x Length | 2.95 x 6 m |

- The photo background made from hard-wearing fabric can be used in many different ways, even without fixed background mounting
- Photo studio to go: for more picture depth, you can simply hang the fabric background over a sofa, chair or cabinet, making it ideal for all bloggers and vloggers who are on the move a lot

|       |  |   |    |  |          |
|-------|--|---|----|--|----------|
| White |  |   |    |  | 00021156 |
|       |  | 6 | SC |  |          |

# Background Carton



**hama**

**Bluescreen Background, Fabric, 2.95 x 6 m, royal blue**

|                |            |
|----------------|------------|
| Material       | Cotton     |
| Width x Length | 2.95 x 6 m |

- The photo background made from hard-wearing fabric can be used in many different ways, even without fixed background mounting
- Photo studio to go: for more picture depth, you can simply hang the fabric background over a sofa, chair or cabinet, making it ideal for all bloggers and vloggers who are on the move a lot

|            |                 |
|------------|-----------------|
| Royal Blue | <b>00021159</b> |
| 6 SC       |                 |



**hama**

**Photo Studio Background, Fabric, 2.95 x 6 m, black**

|                |            |
|----------------|------------|
| Material       | Cotton     |
| Width x Length | 2.95 x 6 m |

- The photo background made from hard-wearing fabric can be used in many different ways, even without fixed background mounting
- Photo studio to go: for more picture depth, you can simply hang the fabric background over a sofa, chair or cabinet, making it ideal for all bloggers and vloggers who are on the move a lot

|       |                 |
|-------|-----------------|
| Black | <b>00021157</b> |
| 6 SC  |                 |



**hama**

**Background 1,35 x 11 m, deep blue**

|                |             |
|----------------|-------------|
| Material       | Cardboard   |
| Width x Length | 1.35 x 11 m |

- Coloured paper background, matt, non-fading, on a cardboard core

|           |                 |
|-----------|-----------------|
| Deep Blue | <b>00021401</b> |
| 1 K.A.    |                 |

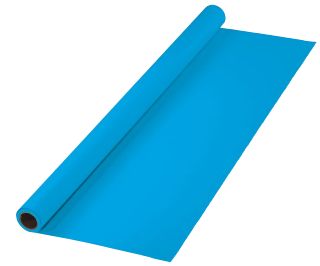

**hama**

**Background 1,35 x 11 m, nassau blue**

|                |             |
|----------------|-------------|
| Material       | Cardboard   |
| Width x Length | 1.35 x 11 m |

- Coloured paper background, matt, non-fading, on a cardboard core

|             |                 |
|-------------|-----------------|
| Nassau Blue | <b>00021406</b> |
| 1 K.A.      |                 |



**hama**

**Greenscreen Background, Fabric, 2.95 x 6 m, green**

|                |            |
|----------------|------------|
| Material       | Cotton     |
| Width x Length | 2.95 x 6 m |

- The photo background made from hard-wearing fabric can be used in many different ways, even without fixed background mounting
- Photo studio to go: for more picture depth, you can simply hang the fabric background over a sofa, chair or cabinet, making it ideal for all bloggers and vloggers who are on the move a lot

|       |                 |
|-------|-----------------|
| Green | <b>00021158</b> |
| 6 SC  |                 |



**hama**

**Background 1,35 x 11 m, arctic white**

|                |             |
|----------------|-------------|
| Material       | Cardboard   |
| Width x Length | 1.35 x 11 m |

- Coloured paper background, matt, non-fading, on a cardboard core

|              |                 |
|--------------|-----------------|
| Arctic White | <b>00021493</b> |
| 1 K.A.       |                 |



**hama**

**Background 1,35 x 11 m, light blue**

|                |             |
|----------------|-------------|
| Material       | Cardboard   |
| Width x Length | 1.35 x 11 m |

- Coloured paper background, matt, non-fading, on a cardboard core

|            |                 |
|------------|-----------------|
| Light Blue | <b>00021402</b> |
| 1 K.A.     |                 |



**hama**

**Background 1,35 x 11 m, navy blue**

|                |             |
|----------------|-------------|
| Material       | Cardboard   |
| Width x Length | 1.35 x 11 m |

- Coloured paper background, matt, non-fading, on a cardboard core

|           |                 |
|-----------|-----------------|
| Navy Blue | <b>00021441</b> |
| 1 K.A.    |                 |

PHOTO-STUDIO

# Background Carton



**hama**

Background 1,35 x 11 m, blue

|                |             |
|----------------|-------------|
| Material       | Cardboard   |
| Width x Length | 1.35 x 11 m |

- Coloured paper background, matt, non-fading, on a cardboard core

|      |          |
|------|----------|
| Blue | 00021460 |
| 1    | K.A.     |



**hama**

Background 1,35 x 11 m, beige

|                |             |
|----------------|-------------|
| Material       | Cardboard   |
| Width x Length | 1.35 x 11 m |

- Coloured paper background, matt, non-fading, on a cardboard core

|       |          |
|-------|----------|
| Beige | 00021425 |
| 1     | K.A.     |



**hama**

Background 1,35 x 11 m, fawn brown

|                |             |
|----------------|-------------|
| Material       | Cardboard   |
| Width x Length | 1.35 x 11 m |

- Coloured paper background, matt, non-fading, on a cardboard core

|            |          |
|------------|----------|
| Fawn Brown | 00021467 |
| 1          | K.A.     |



**hama**

Background 1,35 x 11 m, orange

|                |             |
|----------------|-------------|
| Material       | Cardboard   |
| Width x Length | 1.35 x 11 m |

- Coloured paper background, matt, non-fading, on a cardboard core

|        |          |
|--------|----------|
| Orange | 00021439 |
| 1      | K.A.     |

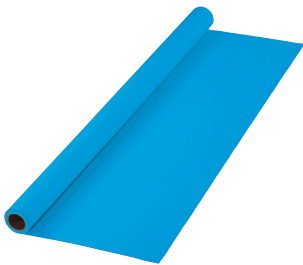

**hama**

Background 1,35 x 11 m, sea blue

|                |             |
|----------------|-------------|
| Material       | Cardboard   |
| Width x Length | 1.35 x 11 m |

- Coloured paper background, matt, non-fading, on a cardboard core

|            |          |
|------------|----------|
| Water Blue | 00021461 |
| 1          | K.A.     |



**hama**

Background 1,35 x 11 m, sand

|                |             |
|----------------|-------------|
| Material       | Cardboard   |
| Width x Length | 1.35 x 11 m |

- Coloured paper background, matt, non-fading, on a cardboard core

|      |          |
|------|----------|
| Sand | 00021466 |
| 1    | K.A.     |

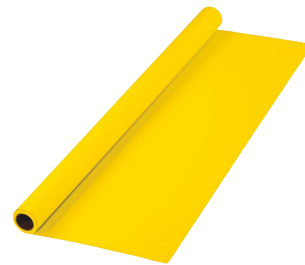

**hama**

Background 1,35 x 11 m, yellow

|                |             |
|----------------|-------------|
| Material       | Cardboard   |
| Width x Length | 1.35 x 11 m |

- Coloured paper background, matt, non-fading, on a cardboard core

|        |          |
|--------|----------|
| Yellow | 00021414 |
| 1      | K.A.     |



**hama**

Background 1,35 x 11 m, light gold

|                |             |
|----------------|-------------|
| Material       | Cardboard   |
| Width x Length | 1.35 x 11 m |

- Coloured paper background, matt, non-fading, on a cardboard core

|            |          |
|------------|----------|
| Light Gold | 00021418 |
| 1          | K.A.     |

PHOTO-STUDIO

# Background Carton



**hama**

Background 1,35 x 11 m, light grey

|                |             |
|----------------|-------------|
| Material       | Cardboard   |
| Width x Length | 1.35 x 11 m |

- Coloured paper background, matt, non-fading, on a cardboard core
- Especially suited for passport photos according to the new ePass guidelines

|            |                 |
|------------|-----------------|
| Light Grey | <b>00021423</b> |
|            | 1 K.A.          |



**hama**

Background 1,35 x 11 m, lead-grey

|                |             |
|----------------|-------------|
| Material       | Cardboard   |
| Width x Length | 1.35 x 11 m |

- Coloured paper background, matt, non-fading, on a cardboard core

|       |                 |
|-------|-----------------|
| Livid | <b>00021457</b> |
|       | 1 K.A.          |



**hama**

Background 1,35 x 11 m, neutral grey

|                |             |
|----------------|-------------|
| Material       | Cardboard   |
| Width x Length | 1.35 x 11 m |

- Coloured paper background, matt, non-fading, on a cardboard core
- Especially suited for passport photos according to the new ePass guidelines

|              |                 |
|--------------|-----------------|
| Neutral Grey | <b>00021404</b> |
|              | 1 K.A.          |



**hama**

Background 1,35 x 11 m, apple-green

|                |             |
|----------------|-------------|
| Material       | Cardboard   |
| Width x Length | 1.35 x 11 m |

- Coloured paper background, matt, non-fading, on a cardboard core

|             |                 |
|-------------|-----------------|
| Apple Green | <b>00021463</b> |
|             | 1 K.A.          |



**hama**

Background 1,35 x 11 m, dove-grey

|                |             |
|----------------|-------------|
| Material       | Cardboard   |
| Width x Length | 1.35 x 11 m |

- Coloured paper background, matt, non-fading, on a cardboard core
- Especially suited for passport photos according to the new ePass guidelines

|           |                 |
|-----------|-----------------|
| Dove-Grey | <b>00021443</b> |
|           | 1 K.A.          |



**hama**

Background 1,35 x 11 m, slate-grey

|                |             |
|----------------|-------------|
| Material       | Cardboard   |
| Width x Length | 1.35 x 11 m |

- Coloured paper background, matt, non-fading, on a cardboard core
- Especially suited for passport photos according to the new ePass guidelines

|            |                 |
|------------|-----------------|
| Slate Grey | <b>00021458</b> |
|            | 1 K.A.          |



**hama**

Background 1,35 x 11 m, dark green

|                |             |
|----------------|-------------|
| Material       | Cardboard   |
| Width x Length | 1.35 x 11 m |

- Coloured paper background, matt, non-fading, on a cardboard core

|            |                 |
|------------|-----------------|
| Dark Green | <b>00021412</b> |
|            | 1 K.A.          |



**hama**

Background 1,35 x 11 m, fiery red

|                |             |
|----------------|-------------|
| Material       | Cardboard   |
| Width x Length | 1.35 x 11 m |

- Coloured paper background, matt, non-fading, on a cardboard core

|           |                 |
|-----------|-----------------|
| Fiery Red | <b>00021427</b> |
|           | 1 K.A.          |

PHOTO-STUDIO



# Background Carton



**hama**

Background 1,35 x 11 m, scarlet

|                |             |
|----------------|-------------|
| Material       | Cardboard   |
| Width x Length | 1.35 x 11 m |

- Coloured paper background, matt, non-fading, on a cardboard core

|         |          |
|---------|----------|
| Scarlet | 00021456 |
| 1       | K.A.     |



**hama**

Background 1,35 x 11 m, black

|                |             |
|----------------|-------------|
| Material       | Cardboard   |
| Width x Length | 1.35 x 11 m |

- Coloured paper background, matt, non-fading, on a cardboard core

|       |          |
|-------|----------|
| Black | 00021444 |
| 1     | K.A.     |



**hama**

Background 1,35 x 11 m, snow white

|                |             |
|----------------|-------------|
| Material       | Cardboard   |
| Width x Length | 1.35 x 11 m |

- Coloured paper background, matt, non-fading, on a cardboard core
- Especially suited for passport photos according to the new ePass guidelines

|            |          |
|------------|----------|
| Snow-White | 00021428 |
| 1          | K.A.     |



**hama**

Background 2,75 x 11 m, deep blue

|                |             |
|----------------|-------------|
| Material       | Cardboard   |
| Width x Length | 2.75 x 11 m |

- Coloured paper background, matt, non-fading, on a cardboard core

|           |          |
|-----------|----------|
| Deep Blue | 00021501 |
| 1         | K.A.     |



**hama**

Background 1,35 x 11 m, violet

|                |             |
|----------------|-------------|
| Material       | Cardboard   |
| Width x Length | 1.35 x 11 m |

- Coloured paper background, matt, non-fading, on a cardboard core

|        |          |
|--------|----------|
| Violet | 00021468 |
| 1      | K.A.     |



**hama**

Background 1,35 x 11 m, natural silk

|                |             |
|----------------|-------------|
| Material       | Cardboard   |
| Width x Length | 1.35 x 11 m |

- Coloured paper background, matt, non-fading, on a cardboard core

|              |          |
|--------------|----------|
| Natural Silk | 00021426 |
| 1            | K.A.     |



**hama**

Background 2,75 x 11 m, arctic white

|                |             |
|----------------|-------------|
| Material       | Cardboard   |
| Width x Length | 2.75 x 11 m |

- Coloured paper background, matt, non-fading, on a cardboard core

|              |          |
|--------------|----------|
| Arctic White | 00021593 |
| 1            | K.A.     |

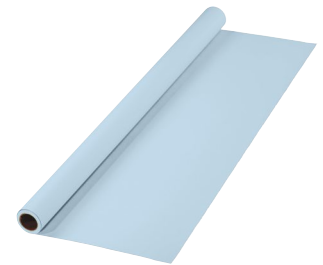

**hama**

Background 2,75 x 11 m, light blue

|                |             |
|----------------|-------------|
| Material       | Cardboard   |
| Width x Length | 2.75 x 11 m |

- Coloured paper background, matt, non-fading, on a cardboard core

|            |          |
|------------|----------|
| Light Blue | 00021502 |
| 1          | K.A.     |

PHOTO-STUDIO

# Background Carton

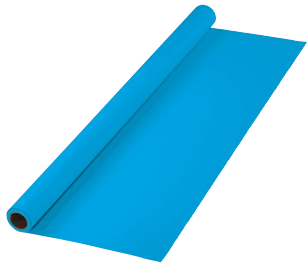

**hama**

Background 2,75 x 11 m,  
nassau blue

|                |             |
|----------------|-------------|
| Material       | Cardboard   |
| Width x Length | 2.75 x 11 m |

- Coloured paper background, matt, non-fading, on a cardboard core

|             |                 |
|-------------|-----------------|
| Nassau Blue | <b>00021506</b> |
| 1           | K.A.            |



**hama**

Background 2,75 x 11 m,  
turquoise

|                |             |
|----------------|-------------|
| Material       | Cardboard   |
| Width x Length | 2.75 x 11 m |

- Coloured paper background, matt, non-fading, on a cardboard core

|           |                 |
|-----------|-----------------|
| Turquoise | <b>00021555</b> |
| 1         | K.A.            |

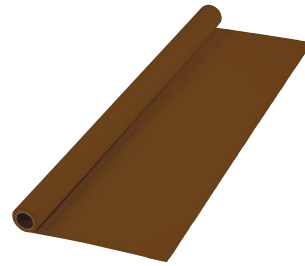

**hama**

Background 2,75 x 11 m, dark  
brown

|                |             |
|----------------|-------------|
| Material       | Cardboard   |
| Width x Length | 2.75 x 11 m |

- Coloured paper background, matt, non-fading, on a cardboard core

|            |                 |
|------------|-----------------|
| Dark Brown | <b>00021520</b> |
| 1          | K.A.            |



**hama**

Background 2,75 x 11 m,  
brown

|                |             |
|----------------|-------------|
| Material       | Cardboard   |
| Width x Length | 2.75 x 11 m |

- Coloured paper background, matt, non-fading, on a cardboard core

|       |                 |
|-------|-----------------|
| Brown | <b>00021548</b> |
| 1     | K.A.            |



**hama**

Background 2,75 x 11 m,  
navy blue

|                |             |
|----------------|-------------|
| Material       | Cardboard   |
| Width x Length | 2.75 x 11 m |

- Coloured paper background, matt, non-fading, on a cardboard core

|           |                 |
|-----------|-----------------|
| Navy Blue | <b>00021541</b> |
| 1         | K.A.            |

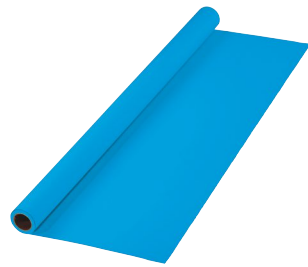

**hama**

Background 2,75 x 11 m, sea  
blue

|                |             |
|----------------|-------------|
| Material       | Cardboard   |
| Width x Length | 2.75 x 11 m |

- Coloured paper background, matt, non-fading, on a cardboard core

|            |                 |
|------------|-----------------|
| Water Blue | <b>00021561</b> |
| 1          | K.A.            |



**hama**

Background 2,75 x 11 m,  
beige

|                |             |
|----------------|-------------|
| Material       | Cardboard   |
| Width x Length | 2.75 x 11 m |

- Coloured paper background, matt, non-fading, on a cardboard core

|       |                 |
|-------|-----------------|
| Beige | <b>00021525</b> |
| 1     | K.A.            |



**hama**

Background 2,75 x 11 m,  
sand

|                |             |
|----------------|-------------|
| Material       | Cardboard   |
| Width x Length | 2.75 x 11 m |

- Coloured paper background, matt, non-fading, on a cardboard core

|      |                 |
|------|-----------------|
| Sand | <b>00021566</b> |
| 1    | K.A.            |

PHOTO-STUDIO



**hama**

Background 2,75 x 11 m,  
fawn brown

|                |             |
|----------------|-------------|
| Material       | Cardboard   |
| Width x Length | 2.75 x 11 m |

- Coloured paper background, matt, non-fading, on a cardboard core

|            |          |
|------------|----------|
| Fawn Brown | 00021567 |
| 1          | K.A.     |



**hama**

Background 2,75 x 11 m,  
yellow-orange

|                |             |
|----------------|-------------|
| Material       | Cardboard   |
| Width x Length | 2.75 x 11 m |

- Coloured paper background, matt, non-fading, on a cardboard core

|                |          |
|----------------|----------|
| Orange, Yellow | 00021535 |
| 1              | K.A.     |



**hama**

Background 2,75 x 11 m, light  
gold

|                |             |
|----------------|-------------|
| Material       | Cardboard   |
| Width x Length | 2.75 x 11 m |

- Coloured paper background, matt, non-fading, on a cardboard core

|            |          |
|------------|----------|
| Light Gold | 00021518 |
| 1          | K.A.     |



**hama**

Background 2,75 x 11 m,  
dove-grey

|                |             |
|----------------|-------------|
| Material       | Cardboard   |
| Width x Length | 2.75 x 11 m |

- Coloured paper background, matt, non-fading, on a cardboard core
- Especially suited for passport photos according to the new ePass guidelines

|           |          |
|-----------|----------|
| Dove-Grey | 00021543 |
| 1         | K.A.     |

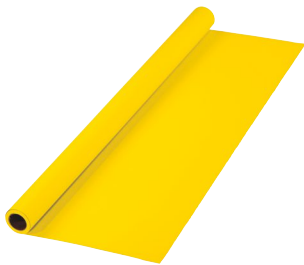

**hama**

Background 2,75 x 11 m,  
yellow

|                |             |
|----------------|-------------|
| Material       | Cardboard   |
| Width x Length | 2.75 x 11 m |

- Coloured paper background, matt, non-fading, on a cardboard core

|        |          |
|--------|----------|
| Yellow | 00021514 |
| 1      | K.A.     |



**hama**

Background 2,75 x 11 m,  
orange

|                |             |
|----------------|-------------|
| Material       | Cardboard   |
| Width x Length | 2.75 x 11 m |

- Coloured paper background, matt, non-fading, on a cardboard core

|        |          |
|--------|----------|
| Orange | 00021539 |
| 1      | K.A.     |



**hama**

Background 2,75 x 11 m, light  
grey

|                |             |
|----------------|-------------|
| Material       | Cardboard   |
| Width x Length | 2.75 x 11 m |

- Coloured paper background, matt, non-fading, on a cardboard core
- Especially suited for passport photos according to the new ePass guidelines

|            |          |
|------------|----------|
| Light Grey | 00021523 |
| 1          | K.A.     |



**hama**

Background 2,75 x 11 m,  
lead-grey

|                |             |
|----------------|-------------|
| Material       | Cardboard   |
| Width x Length | 2.75 x 11 m |

- Coloured paper background, matt, non-fading, on a cardboard core

|       |          |
|-------|----------|
| Livid | 00021557 |
| 1     | K.A.     |

# Background Carton



**hama**

Background 2,75 x 11 m, slate-grey

|                |             |
|----------------|-------------|
| Material       | Cardboard   |
| Width x Length | 2.75 x 11 m |

- Coloured paper background, matt, non-fading, on a cardboard core
- Especially suited for passport photos according to the new ePass guidelines

|            |                 |
|------------|-----------------|
| Slate Grey | <b>00021558</b> |
|            | 1 K.A.          |



**hama**

Background 2,75 x 11 m, dark green

|                |             |
|----------------|-------------|
| Material       | Cardboard   |
| Width x Length | 2.75 x 11 m |

- Coloured paper background, matt, non-fading, on a cardboard core

|            |                 |
|------------|-----------------|
| Dark Green | <b>00021512</b> |
|            | 1 K.A.          |



**hama**

Background 2,75 x 11 m, apple-green

|                |             |
|----------------|-------------|
| Material       | Cardboard   |
| Width x Length | 2.75 x 11 m |

- Coloured paper background, matt, non-fading, on a cardboard core

|             |                 |
|-------------|-----------------|
| Apple Green | <b>00021563</b> |
|             | 1 K.A.          |



**hama**

Background 2,75 x 11 m, fiery red

|                |             |
|----------------|-------------|
| Material       | Cardboard   |
| Width x Length | 2.75 x 11 m |

- Coloured paper background, matt, non-fading, on a cardboard core

|           |                 |
|-----------|-----------------|
| Fiery Red | <b>00021527</b> |
|           | 1 K.A.          |



**hama**

Background 2,75 x 11 m, neutral grey

|                |             |
|----------------|-------------|
| Material       | Cardboard   |
| Width x Length | 2.75 x 11 m |

- Coloured paper background, matt, non-fading, on a cardboard core
- Especially suited for passport photos according to the new ePass guidelines

|              |                 |
|--------------|-----------------|
| Neutral Grey | <b>00021504</b> |
|              | 1 K.A.          |



**hama**

Background 2,75 x 11 m, aspen

|                |             |
|----------------|-------------|
| Material       | Cardboard   |
| Width x Length | 2.75 x 11 m |

- Coloured paper background, matt, non-fading, on a cardboard core

|       |                 |
|-------|-----------------|
| Aspen | <b>00021550</b> |
|       | 1 K.A.          |



**hama**

Background 2,75 x 11 m, pink

|                |             |
|----------------|-------------|
| Material       | Cardboard   |
| Width x Length | 2.75 x 11 m |

- Coloured paper background, matt, non-fading, on a cardboard core

|      |                 |
|------|-----------------|
| Pink | <b>00021517</b> |
|      | 1 K.A.          |



**hama**

Background 2,75 x 11 m, lilac

|                |             |
|----------------|-------------|
| Material       | Cardboard   |
| Width x Length | 2.75 x 11 m |

- Coloured paper background, matt, non-fading, on a cardboard core

|        |                 |
|--------|-----------------|
| Purple | <b>00021529</b> |
|        | 1 K.A.          |

PHOTO-STUDIO

# Background Carton



**hama**

Background 2,75 x 11 m, crimson

|                |             |
|----------------|-------------|
| Material       | Cardboard   |
| Width x Length | 2.75 x 11 m |

- Coloured paper background, matt, non-fading, on a cardboard core

|         |   |      |  |  |          |
|---------|---|------|--|--|----------|
| Crimson |   |      |  |  | 00021549 |
|         | 1 | K.A. |  |  |          |



**hama**

Background 2,75 x 11 m, red violet

|                |             |
|----------------|-------------|
| Material       | Cardboard   |
| Width x Length | 2.75 x 11 m |

- Coloured paper background, matt, non-fading, on a cardboard core

|             |   |      |  |  |          |
|-------------|---|------|--|--|----------|
| Red, Violet |   |      |  |  | 00021562 |
|             | 1 | K.A. |  |  |          |



**hama**

Background 2,75 x 11 m, black

|                |             |
|----------------|-------------|
| Material       | Cardboard   |
| Width x Length | 2.75 x 11 m |

- Coloured paper background, matt, non-fading, on a cardboard core

|       |   |      |  |  |          |
|-------|---|------|--|--|----------|
| Black |   |      |  |  | 00021544 |
|       | 1 | K.A. |  |  |          |



**hama**

Background 2,75 x 11 m, snow white

|                |             |
|----------------|-------------|
| Material       | Cardboard   |
| Width x Length | 2.75 x 11 m |

- Coloured paper background, matt, non-fading, on a cardboard core
- Especially suited for passport photos according to the new ePass guidelines

|            |   |      |  |  |          |
|------------|---|------|--|--|----------|
| Snow-White |   |      |  |  | 00021528 |
|            | 1 | K.A. |  |  |          |



**hama**

Background 2,75 x 11 m, scarlet

|                |             |
|----------------|-------------|
| Material       | Cardboard   |
| Width x Length | 2.75 x 11 m |

- Coloured paper background, matt, non-fading, on a cardboard core

|         |   |      |  |  |          |
|---------|---|------|--|--|----------|
| Scarlet |   |      |  |  | 00021556 |
|         | 1 | K.A. |  |  |          |



**hama**

Background 2,75 x 11 m, violet

|                |             |
|----------------|-------------|
| Material       | Cardboard   |
| Width x Length | 2.75 x 11 m |

- Coloured paper background, matt, non-fading, on a cardboard core

|        |   |      |  |  |          |
|--------|---|------|--|--|----------|
| Violet |   |      |  |  | 00021568 |
|        | 1 | K.A. |  |  |          |



**hama**

Background 2,75 x 11 m, natural silk

|                |             |
|----------------|-------------|
| Material       | Cardboard   |
| Width x Length | 2.75 x 11 m |

- Coloured paper background, matt, non-fading, on a cardboard core

|              |   |      |  |  |          |
|--------------|---|------|--|--|----------|
| Natural Silk |   |      |  |  | 00021526 |
|              | 1 | K.A. |  |  |          |



**hama**

Background 2,75 x 11 m, ivory

|                |             |
|----------------|-------------|
| Material       | Cardboard   |
| Width x Length | 2.75 x 11 m |

- Coloured paper background, matt, non-fading, on a cardboard core

|       |   |      |  |  |          |
|-------|---|------|--|--|----------|
| Ivory |   |      |  |  | 00021533 |
|       | 1 | K.A. |  |  |          |

PHOTO-STUDIO

# Background Carton



**hama**

Background 2,75 x 11 m, light ivory

|                |             |
|----------------|-------------|
| Material       | Cardboard   |
| Width x Length | 2.75 x 11 m |

- Coloured paper background, matt, non-fading, on a cardboard core

|             |          |
|-------------|----------|
| Light Ivory | 00021564 |
| 1           | K.A.     |



**hama**

Background, Cardboard, 3.60 m x 30 m, black

|                |            |
|----------------|------------|
| Material       | Cardboard  |
| Width x Length | 3.6 x 30 m |

- Especially thick cardboard, bulk-dyed, light-fast, matt, 360 cm wide, on cardboard tube

|       |          |
|-------|----------|
| Black | 00021147 |
| 1     | K.A.     |



**hama**

Background, Cardboard, 3.60 m x 30 m, Arctic white

|                |            |
|----------------|------------|
| Material       | Cardboard  |
| Width x Length | 3.6 x 30 m |

- Especially thick cardboard, bulk-dyed, light-fast, matt, 360 cm wide, on cardboard tube
- Especially suitable for passport photographs compliant with the new EU passport guidelines

|              |          |
|--------------|----------|
| Arctic White | 00021146 |
| 1            | K.A.     |

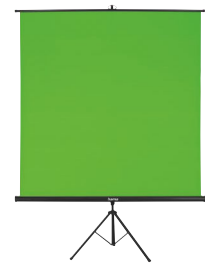

**hama**

Green Screen Background with Tripod, 180 x 180 cm, 2 in 1

|                |             |
|----------------|-------------|
| Width x Length | 180 x 180 m |
|----------------|-------------|

- The green-screen background with quick-release clip can be removed from the tripod and hung up on its own
- The spring mechanism allows the green screen to be easily extended to the required size and secured in place, remaining crease-free in the process
- Continually adjustable telescope tube (total height 235 - 270 cm)

|   |          |
|---|----------|
|   | 00021571 |
| 1 | SC       |



**hama**

Background, Cardboard, 2.75 x 11 m, Green-Screen-Compatible, mint green

|                |             |
|----------------|-------------|
| Material       | Cardboard   |
| Width x Length | 2.75 x 11 m |

- Mass-dyed background, matt, light-proof, on cardboard tube

|            |          |
|------------|----------|
| Mint green | 00021534 |
| 1          | K.A.     |



**hama**

Background, Cardboard, 3.60 m x 30 m, dove grey

|                |            |
|----------------|------------|
| Material       | Cardboard  |
| Width x Length | 3.6 x 30 m |

- Especially thick cardboard, bulk-dyed, light-fast, matt, 360 cm wide, on cardboard tube

|           |          |
|-----------|----------|
| Dove-Grey | 00021148 |
| 1         | K.A.     |

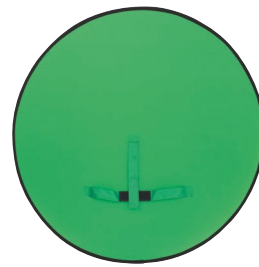

**hama**

"Chairy" Folding Background, for Attachment to Chair Backs, green, Ø 130 cm

|          |       |
|----------|-------|
| Material | Nylon |
|----------|-------|

- Mobile folding background for streaming, gaming and video conferences in the office, home office and leisure domain
- Ideal for photo and video recordings that can be cropped and digitally edited
- Can be set up in seconds and attached using the universal fixing loop to any conventional chair (for chair backs with a width of approx. 35 cm - 65 cm)

|       |          |
|-------|----------|
| Green | 00021572 |
| 12    | SC       |

PHOTO-STUDIO

## Sample assortment



**hama**

### Colour Sample Card Back-ground Cardboard

- 1 original sample each of the 135, 275 and 360 background in a size of 21.5 x 9 x 0.2 cm

00021104

250





# Optical Products



## Holder



**hama**

### "Alu" Binoculars Tripod Holder with 1/4" Thread

|          |           |
|----------|-----------|
| Material | Aluminium |
|----------|-----------|

- For wobble-free and lengthy observation since both hands remain free
- Firm position of the binoculars on the adapter and tripod
- Easy mounting of the binoculars: simply screw the adapter to the tripod and the binoculars to the adapter
- The binoculars remain fully operable
- Suitable for all binoculars with a 1/4" thread
- Adapter suitable for all tripods with 1/4" (6.4 mm) thread / connection

|       |          |    |
|-------|----------|----|
| Black | 00002809 |    |
|       | 6        | BK |

## Binoculars

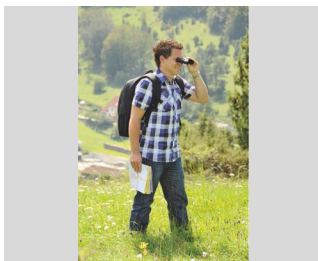

**hama**

### "Optec" Binoculars, 8x21 Compact

|                        |                            |
|------------------------|----------------------------|
| Shade of colour        | Black                      |
| Armouring              | Rubber                     |
| Design                 | Roof                       |
| Diameter of Exit Pupil | 2.62 mm                    |
| Field of View /1000 m  | 122 m                      |
| Focusing               | Joint Focusing Arrangement |
| Lens Coating           | Coated                     |
| Weight                 | 165 g                      |

- The "Blue Coated" antireflection lens coating avoids reflections thus guaranteeing a clear image, especially in case of backlight and dusk or dawn
- Soft touch body for shock protection and an optimal grip, therefore ideal for travel, sport and leisure time
- Due to reversible eyecups also suitable for wearers of glasses
- Compensates up to +/-3 diopters thus delivering clear images for spectacle wearers
- Quick and easy to focus thanks to large focusing wheel

|           |          |    |
|-----------|----------|----|
| 8x x21 mm | 00002800 |    |
|           | 12       | SC |

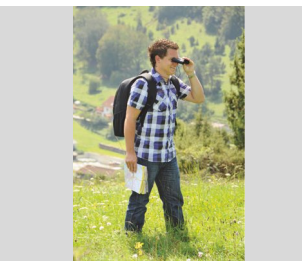

**hama**

### "Optec" Binoculars, 12x25 Compact

|                        |                            |
|------------------------|----------------------------|
| Shade of colour        | Black                      |
| Armouring              | Rubber                     |
| Design                 | Roof                       |
| Diameter of Exit Pupil | 2.08 mm                    |
| Field of View /1000 m  | 78 m                       |
| Focusing               | Joint Focusing Arrangement |
| Lens Coating           | Coated                     |
| Weight                 | 246 g                      |

- The "Blue Coated" antireflection lens coating avoids reflections thus guaranteeing a clear image, especially in case of backlight and dusk or dawn
- Soft touch body for shock protection and an optimal grip, therefore ideal for travel, sport and leisure time
- Due to reversible eyecups also suitable for wearers of glasses
- Compensates up to +/-3 diopters thus delivering clear images for spectacle wearers
- Quick and easy to focus thanks to large focusing wheel

|            |          |    |
|------------|----------|----|
| 12x x25 mm | 00002802 |    |
|            | 12       | HB |

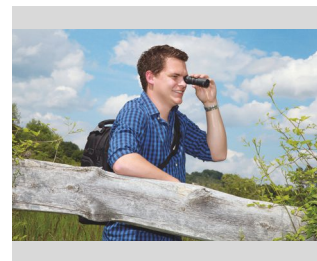

**hama**

### "Optec" Monocular, 10 x 25

|                        |                        |
|------------------------|------------------------|
| Shade of colour        | Black                  |
| Armouring              | Rubber                 |
| Design                 | Monokular              |
| Diameter of Exit Pupil | 2.5 mm                 |
| Field of View /1000 m  | 96 m                   |
| Focusing               | Single Ocular Focusing |
| Lens Coating           | Multi-Coated           |
| Weight                 | 80 g                   |

- The "Blue Coated" antireflection lens coating avoids reflections thus guaranteeing a clear image, especially in case of backlight and dusk or dawn
- BK7 optical glass for a first class image even in extreme situations
- Soft touch body for shock protection and an optimal grip, therefore ideal when travelling as well as for sports and leisure time activities
- Due to reversible eyecups also suitable for wearers of glasses
- Compensates up to +/-3 diopters thus delivering clear images for spectacle wearers

|            |          |    |
|------------|----------|----|
| 10x x25 mm | 00002808 |    |
|            | 15       | SC |

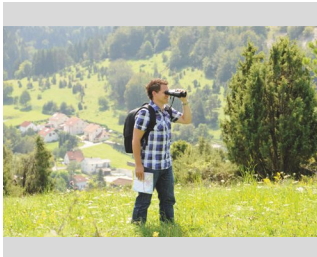

**hama**

**"Optec" Binoculars, 10x50 Prism**

|                        |                            |
|------------------------|----------------------------|
| Shade of colour        | Black                      |
| Armouring              | Rubber                     |
| Design                 | Porro                      |
| Diameter of Exit Pupil | 5 mm                       |
| Field of View /1000 m  | 101 m                      |
| Focusing               | Joint Focusing Arrangement |
| Lens Coating           | Coated                     |
| Weight                 | 830 g                      |

- The "Blue Coated" antireflection lens coating avoids reflections thus guaranteeing a clear image, especially in case of backlight and dusk or dawn
- Soft touch body for shock protection and an optimal grip, therefore ideal for travel, sport and leisure time
- Due to reversible eyecups also suitable for wearers of glasses
- Compensates up to +/-3 diopters thus delivering clear images for spectacle wearers
- Quick and easy to focus thanks to large focusing wheel
- 1/4" (6.4 mm) thread allows you to attach a tripod (includes thread cover)

|            |                 |
|------------|-----------------|
| 10x x50 mm | <b>00002804</b> |
|            | 8 SC            |

**Magnifier**



**hama**

**"Basic 75" Magnifying Glass, 12 pcs. in display**

|                           |       |
|---------------------------|-------|
| Max. Magnification Factor | 1.75  |
| Height                    | 80 mm |
| Lens Diameter             | 75 mm |
| Width                     | 80 mm |

- With convenient handle
- 75 mm diameter for optimum visibility
- Also perfect as a practical vision aid for the elderly to help them read comfortably and independently

|       |                 |
|-------|-----------------|
| Black | <b>00005441</b> |
|       | 12 SC           |



**hama**

**"Basic 90 LED" Reading Magnifier, 18 pcs. in display**

|                           |        |
|---------------------------|--------|
| Max. Magnification Factor | 4      |
| Height                    | 94 mm  |
| Lens Diameter             | 90 mm  |
| Width                     | 202 mm |

- With LED light (2 LEDs)
- With convenient, slim handle
- Large lens diameter 90 mm (2 x magnification) for the best view
- Small lens diameter 21 mm (4 x magnification) for detailed magnification
- Both lenses are combined in one visual field (bifocal)

|       |                 |
|-------|-----------------|
| Black | <b>00005445</b> |
|       | 18 SC           |

## Overview of all products from A to Z

|                             |         |                         |         |                                   |                 |
|-----------------------------|---------|-------------------------|---------|-----------------------------------|-----------------|
| <b>A</b>                    |         | <b>F</b>                |         | <b>R</b>                          |                 |
| Accessories Set             | 34      | File                    | 148     | Release                           | 76              |
| Adapter Ring                | 61      | Flash Adapter/Tilt Head | 90      | Replacement battery               | 82              |
| Adhesive Foil               | 142     | Flash/Lighting Rail     | 90      |                                   |                 |
| Adhesive Paste              | 157     |                         |         | <b>S</b>                          |                 |
| Album Sheets                | 150     | <b>H</b>                |         | Sample assortment                 | 167             |
|                             |         | Half Spindle            | 155     | Screen Protector                  | 75              |
| <b>B</b>                    |         | Hand Strap              | 30, 73  | Screw                             | 55              |
| Backpack                    | 23      | HDMI™-Cable             | 76      | SD Memory Card                    | 100             |
| Bag                         | 98      | Holder                  | 33, 170 | Selfie Stick                      | 32, 41          |
| Ball Joint/Tilt Head        | 42, 52  | Hook and Loop Tape      | 156     | Sleeve                            | 100             |
| Binoculars                  | 170     |                         |         | Slide Magazine                    | 140             |
|                             |         | <b>I</b>                |         | Slide Viewer                      | 140             |
| <b>C</b>                    |         | Internal SSD Hard Drive | 126     | Socket                            | 55              |
| Camera Lens Adapter         | 79      |                         |         | Spirit Level                      | 79              |
| Camera Plate                | 53      | <b>L</b>                |         | Split Ring                        | 74              |
| Camera Quick-Release System | 52      | Label                   | 138     | Storage Sleeve                    | 140, 149        |
| Camera/Accessories Bag      | 13      | Laser Pointer           | 146     |                                   |                 |
| Card Reader                 | 122     | LED Light               | 36      | <b>T</b>                          |                 |
| Carrying Strap              | 30, 72  | Lens filter             | 58      | Telescreen                        | 142             |
| CFast Memory Card           | 107     | Lens hood               | 69      | Tripod                            | 30, 38, 46, 154 |
| CFexpress-Memorycard        | 107     | Lens Pouch/Bag          | 69      | Trolley                           | 22              |
| Charger                     | 85      | Lid                     | 66, 75  |                                   |                 |
| Clamp / Tension Bracket     | 43      | Locking Cone            | 156     | <b>U</b>                          |                 |
| Clamp Extensions            | 55, 154 |                         |         | Umbrella Holder                   | 156             |
| Cleaning Cloth              | 94      | <b>M</b>                |         | USB Cable                         | 77              |
| Cleaning Kit                | 93      | Magnifier               | 171     | USB Lights                        | 44              |
| Cleaning Pen                | 93      | Matt Spray              | 157     | USB Memory Stick                  | 129             |
| Clips/Clamp                 | 58      | Memory Card Box         | 125     |                                   |                 |
| Colt Bag                    | 10      | Microphone              | 44, 79  | <b>V</b>                          |                 |
| Compact Bag                 | 6       | microSD Memory Card     | 108     | Video Cassette Adapter            | 142             |
| CompactFlash Card           | 108     | Mini Photo Studio       | 157     | Video Converter                   | 79              |
| Compressed Air Cleaner      | 92      | Monitor Arm             | 44      |                                   |                 |
| Contact Cleaner             | 92      | MP3 Player (DS)         | 98      | <b>W</b>                          |                 |
| Conversion Bushings         | 55      |                         |         | Wall Bracket for Background Rolls | 155             |
| Cutting Machine/accessories | 152     | <b>O</b>                |         | Weighting Rail                    | 156             |
|                             |         | Organizer Bag           | 13      | Wireless Shutter Release          | 44              |
| <b>D</b>                    |         | Photo Background        | 157     |                                   |                 |
| Dust-Ex Brush               | 92      | Projection Screen       | 144     |                                   |                 |
|                             |         | Projector Table         | 145     |                                   |                 |
| <b>E</b>                    |         | Protection              | 69      |                                   |                 |
| Equipment Bag               | 14      |                         |         |                                   |                 |
| External SSD Hard Drive     | 128     |                         |         |                                   |                 |



## Company headquarters

Hama GmbH & Co KG  
Dresdner Str. 9  
86653 Monheim/Bavaria  
GERMANY  
Tel. +49 9091 502-0  
Fax +49 9091 502-274  
info.de@hama.com  
www.hama.com

[www.facebook.com/Hama.Germany](https://www.facebook.com/Hama.Germany)

All brand names listed are trade marks of the corresponding companies.  
Errors and changes to technology and design are reserved.  
Our general terms and conditions of business apply. Printed in Germany.

097904/11.2023



***hama***